

Profile Knives and Limiters

Cutting Length=40mm Thickness=4mm

Pack Qty. 10



SP

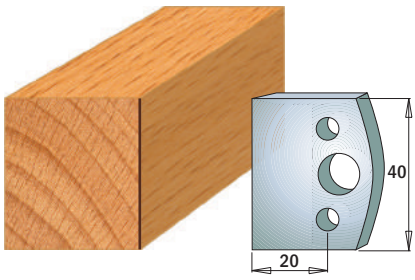

Pair of knives **690.000**
Pair of limiters **691.000**

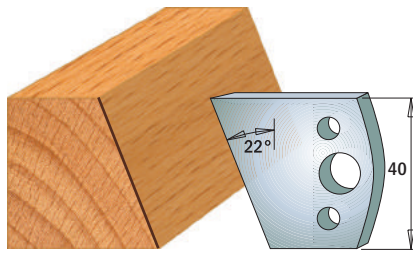

Pair of knives **690.001**
Pair of limiters **691.001**

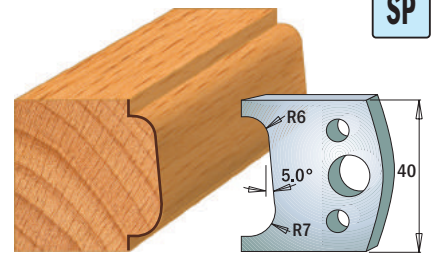

Pair of knives **690.002**
Pair of limiters **691.002**

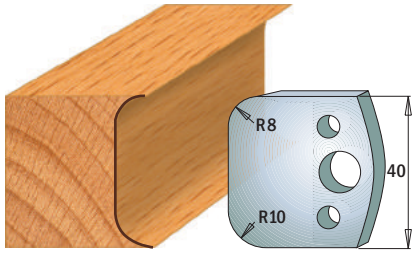

Pair of knives **690.003**
Pair of limiters **691.003**

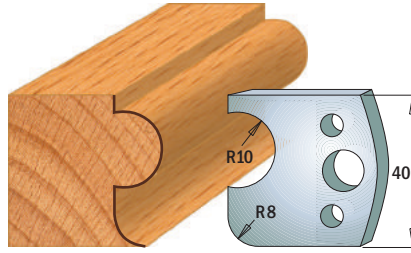

Pair of knives **690.004**
Pair of limiters **691.004**

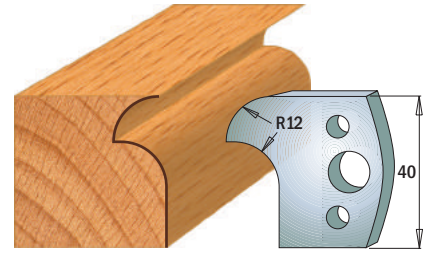

Pair of knives **690.005**
Pair of limiters **691.005**

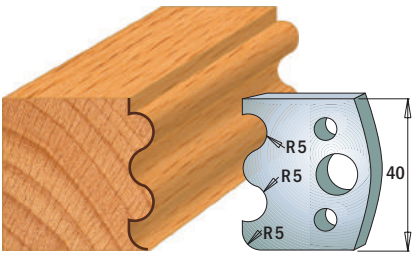

Pair of knives **690.006**
Pair of limiters **691.006**

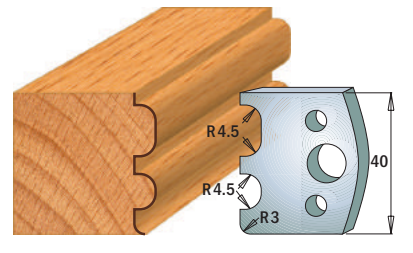

Pair of knives **690.007**
Pair of limiters **691.007**

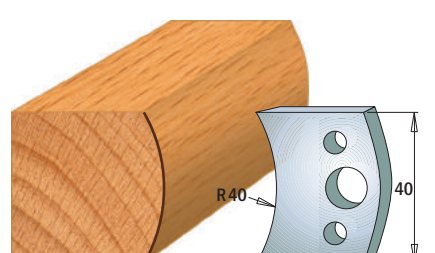

Pair of knives **690.008**
Pair of limiters **691.008**

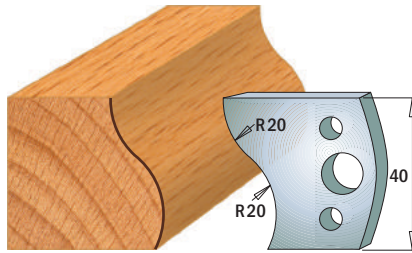

Pair of knives **690.009**
Pair of limiters **691.009**

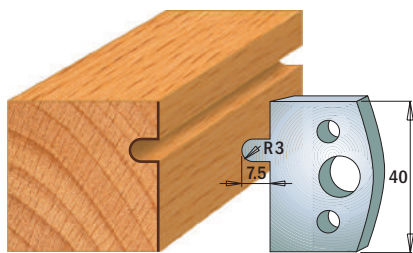

Pair of knives **690.010**
Pair of limiters **691.010**

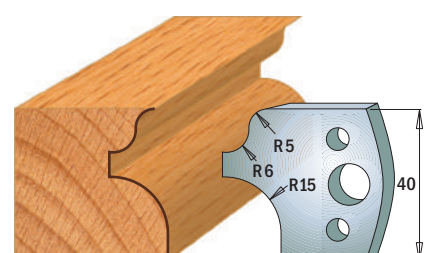

Pair of knives **690.011**
Pair of limiters **691.011**

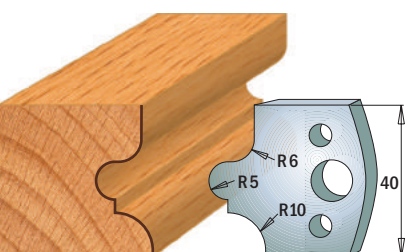

Pair of knives **690.012**
Pair of limiters **691.012**

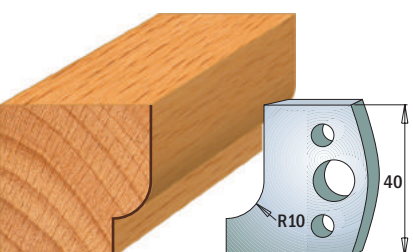

Pair of knives **690.013**
Pair of limiters **691.013**

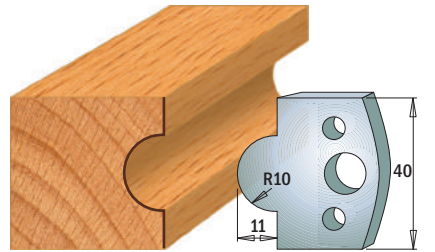

Pair of knives **690.014**
Pair of limiters **691.014**

NOTE: all knives & limiters available only in pairs

Drawings are 1:2 scale

Dimensions in mm.

SP

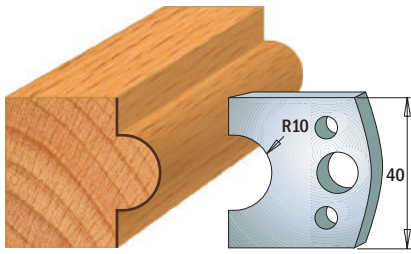

Pair of knives **690.015**
Pair of limiters **691.015**

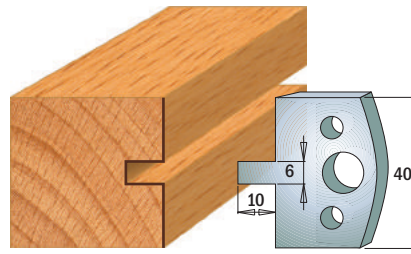

Pair of knives **690.016**
Pair of limiters **691.016**

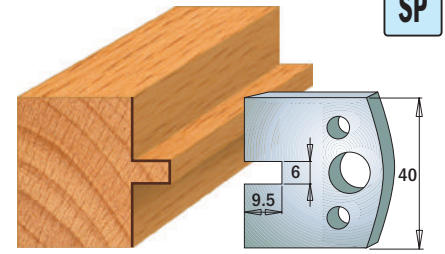

Pair of knives **690.017**
Pair of limiters **691.017**

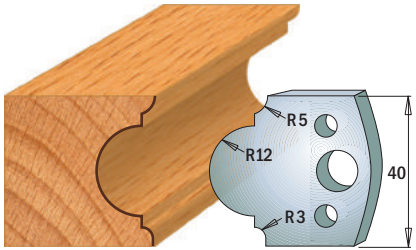

Pair of knives **690.018**
Pair of limiters **691.018**

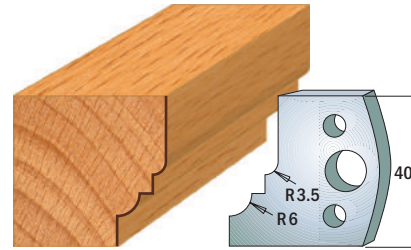

Pair of knives **690.019**
Pair of limiters **691.019**

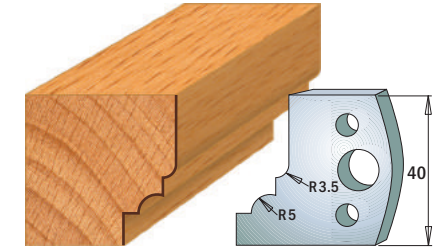

Pair of knives **690.020**
Pair of limiters **691.020**

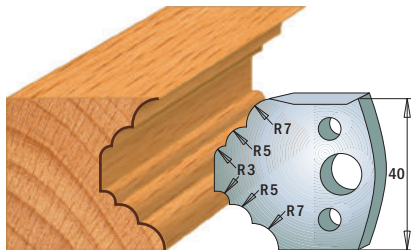

Pair of knives **690.021**
Pair of limiters **691.021**

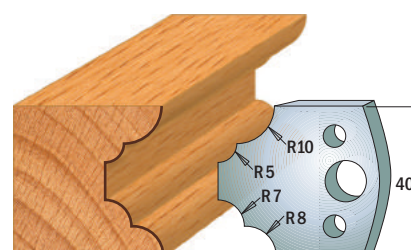

Pair of knives **690.022**
Pair of limiters **691.022**

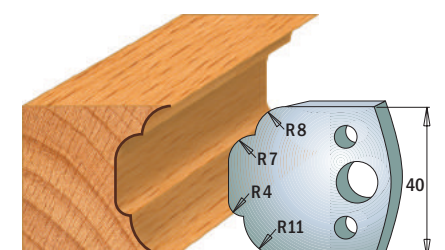

Pair of knives **690.023**
Pair of limiters **691.023**

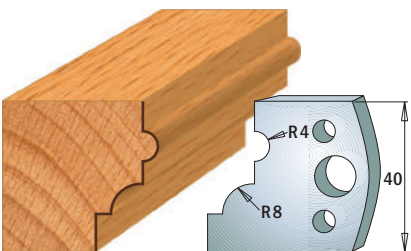

Pair of knives **690.024**
Pair of limiters **691.024**

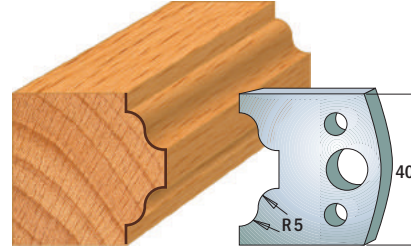

Pair of knives **690.025**
Pair of limiters **691.025**

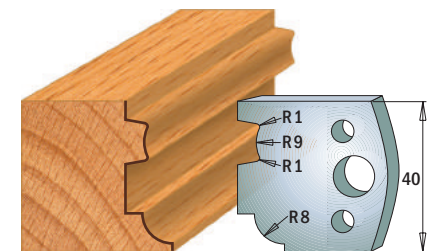

Pair of knives **690.026**
Pair of limiters **691.026**

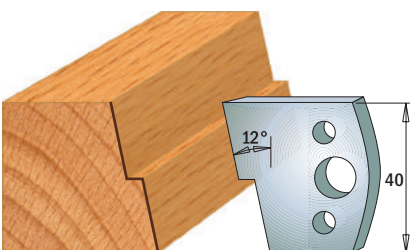

Pair of knives **690.027**
Pair of limiters **691.027**

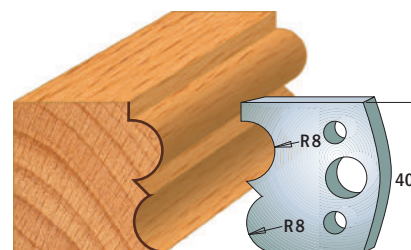

Pair of knives **690.028**
Pair of limiters **691.028**

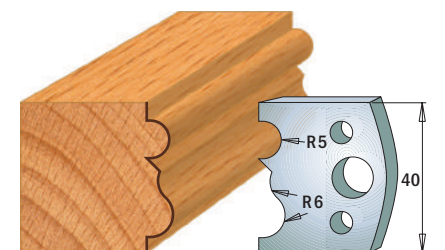

Pair of knives **690.029**
Pair of limiters **691.029**

NOTE: all knives & limiters available only in pairs

Drawings are 1:2 scale

Dimensions in mm.

Profile Knives and Limiters

Cutting Length=40mm Thickness=4mm

Pack Qty. 10



SP

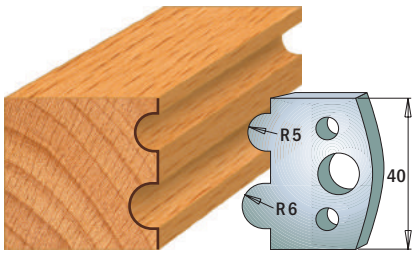

Pair of knives **690.030**
Pair of limiters **691.030**

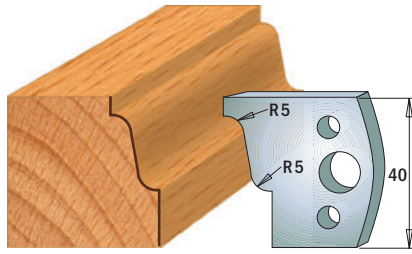

Pair of knives **690.031**
Pair of limiters **691.031**

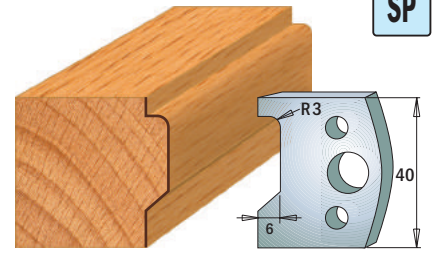

Pair of knives **690.032**
Pair of limiters **691.032**

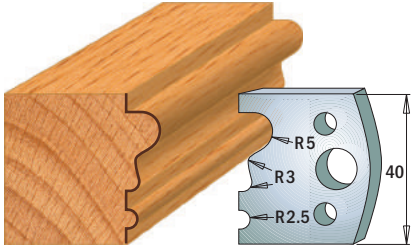

Pair of knives **690.033**
Pair of limiters **691.033**

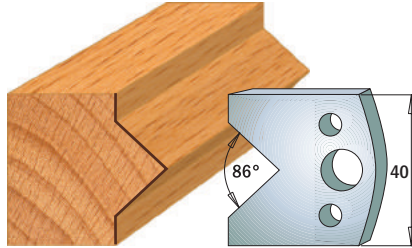

Pair of knives **690.034**
Pair of limiters **691.034**

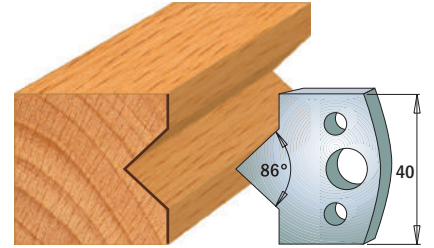

Pair of knives **690.035**
Pair of limiters **691.035**

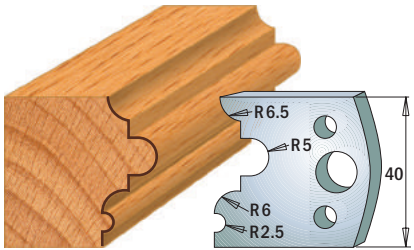

Pair of knives **690.036**
Pair of limiters **691.036**

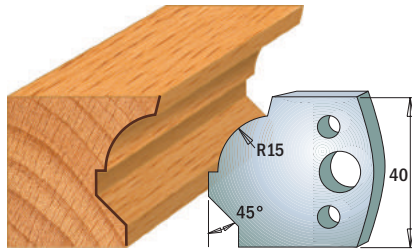

Pair of knives **690.037**
Pair of limiters **691.037**

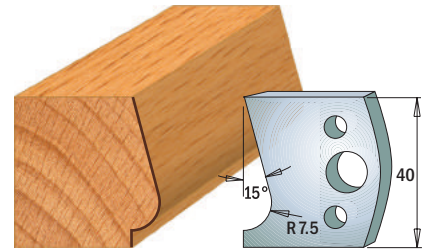

Pair of knives **690.038**
Pair of limiters **691.038**

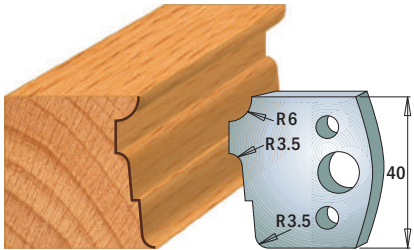

Pair of knives **690.039**
Pair of limiters **691.039**

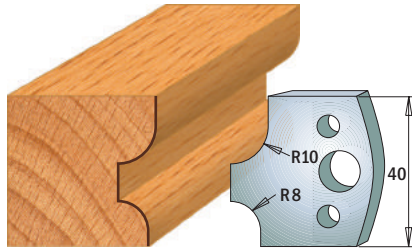

Pair of knives **690.040**
Pair of limiters **691.040**

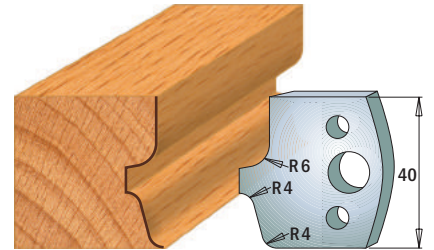

Pair of knives **690.041**
Pair of limiters **691.041**

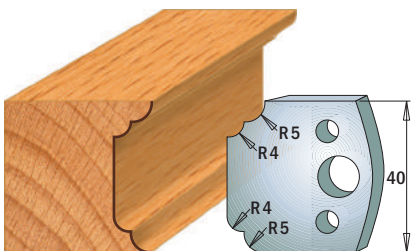

Pair of knives **690.042**
Pair of limiters **691.042**

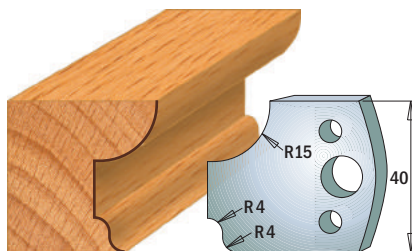

Pair of knives **690.043**
Pair of limiters **691.043**

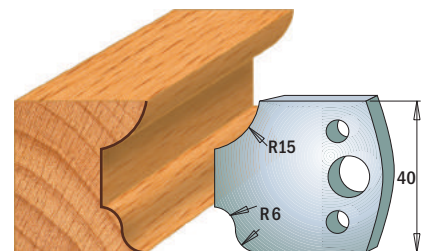

Pair of knives **690.044**
Pair of limiters **691.044**

NOTE: all knives & limiters available only in pairs

Drawings are 1:2 scale

Dimensions in mm.

SP

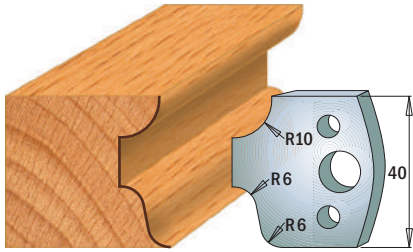

Pair of knives **690.045**
Pair of limiters **691.045**

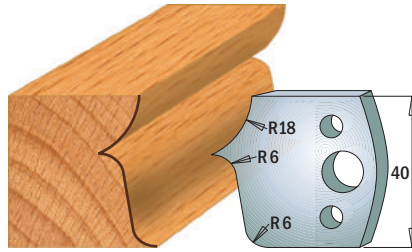

Pair of knives **690.046**
Pair of limiters **691.046**

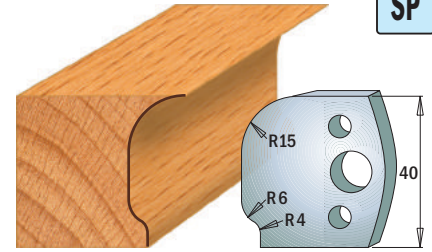

Pair of knives **690.047**
Pair of limiters **691.047**

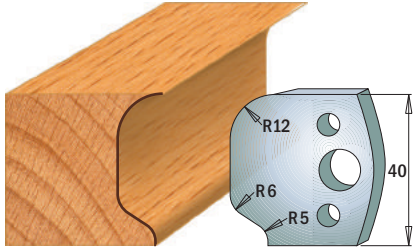

Pair of knives **690.048**
Pair of limiters **691.048**

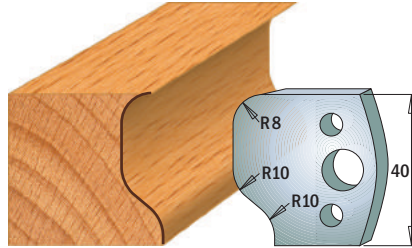

Pair of knives **690.049**
Pair of limiters **691.049**

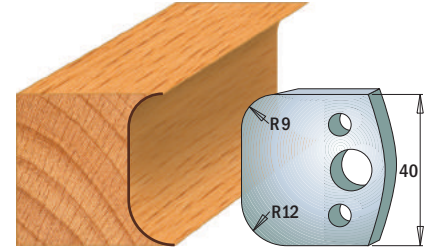

Pair of knives **690.050**
Pair of limiters **691.050**

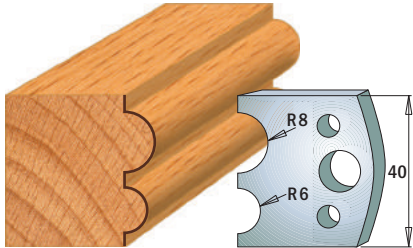

Pair of knives **690.051**
Pair of limiters **691.051**

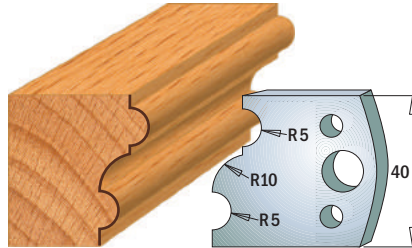

Pair of knives **690.052**
Pair of limiters **691.052**

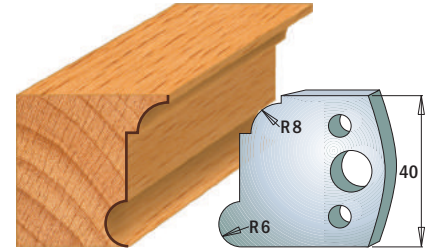

Pair of knives **690.053**
Pair of limiters **691.053**

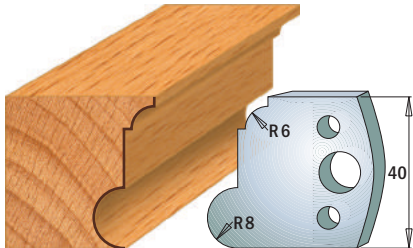

Pair of knives **690.054**
Pair of limiters **691.054**

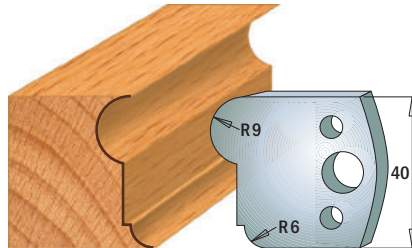

Pair of knives **690.055**
Pair of limiters **691.055**

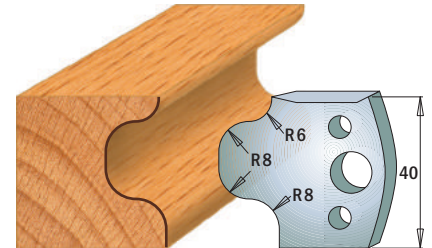

Pair of knives **690.056**
Pair of limiters **691.056**

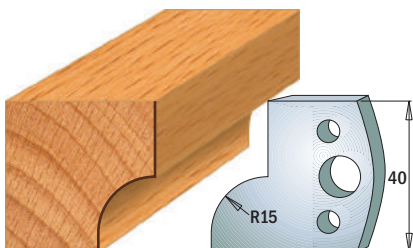

Pair of knives **690.057**
Pair of limiters **691.057**

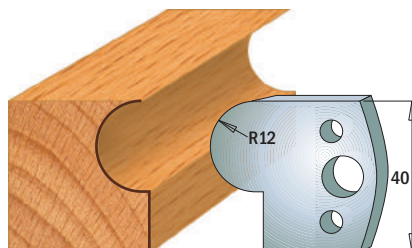

Pair of knives **690.058**
Pair of limiters **691.058**

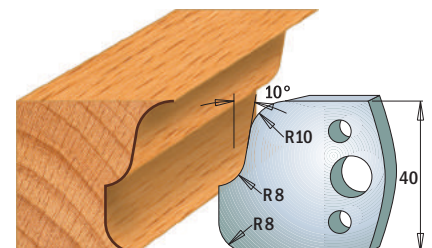

Pair of knives **690.059**
Pair of limiters **691.059**

NOTE: all knives & limiters available only in pairs

Drawings are 1:2 scale

Dimensions in mm.

Profile Knives and Limiters

Cutting Length=40mm Thickness=4mm

Pack Qty. 10



SP

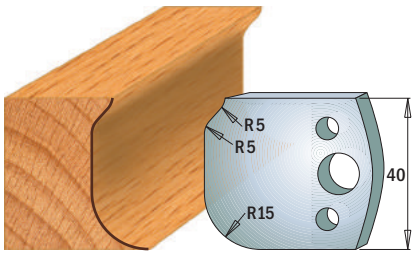

Pair of knives **690.060**
Pair of limiters **691.060**

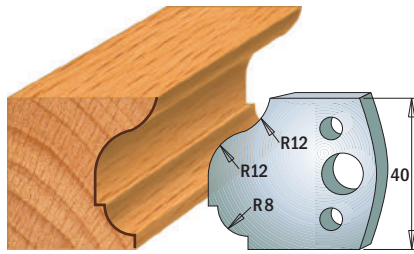

Pair of knives **690.061**
Pair of limiters **691.061**

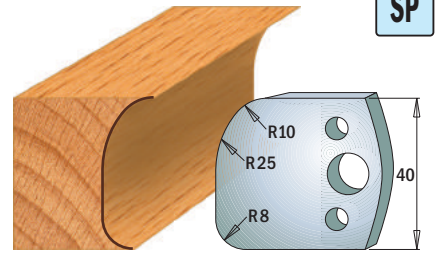

Pair of knives **690.062**
Pair of limiters **691.062**

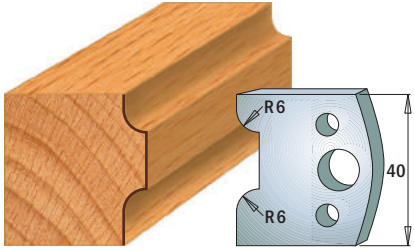

Pair of knives **690.063**
Pair of limiters **691.063**

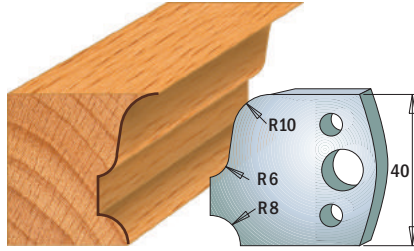

Pair of knives **690.064**
Pair of limiters **691.064**

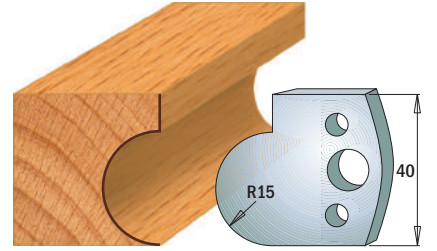

Pair of knives **690.065**
Pair of limiters **691.065**

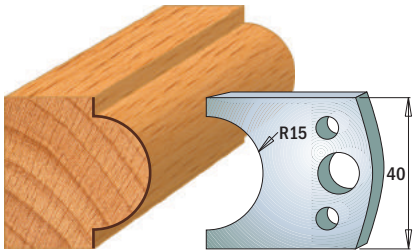

Pair of knives **690.066**
Pair of limiters **691.066**

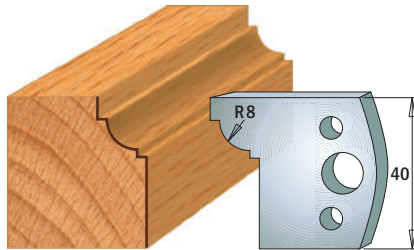

Pair of knives **690.067**
Pair of limiters **691.067**

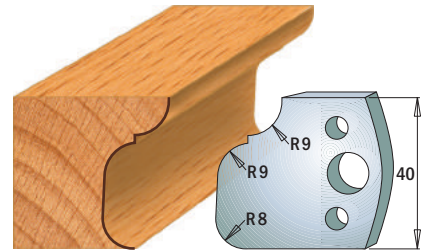

Pair of knives **690.068**
Pair of limiters **691.068**

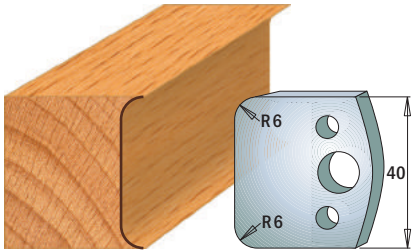

Pair of knives **690.069**
Pair of limiters **691.069**

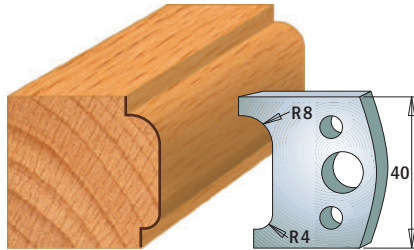

Pair of knives **690.070**
Pair of limiters **691.070**

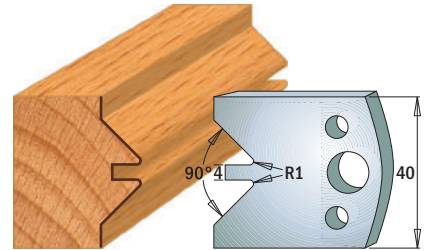

Pair of knives **690.071**
Pair of limiters **691.071**

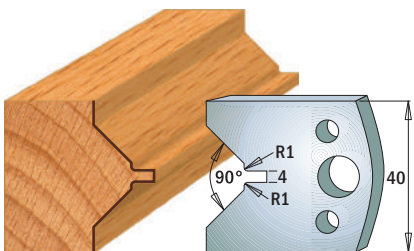

Pair of knives **690.072**
Pair of limiters **691.072**

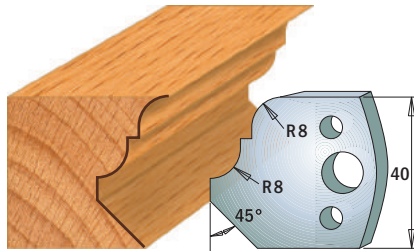

Pair of knives **690.073**
Pair of limiters **691.073**

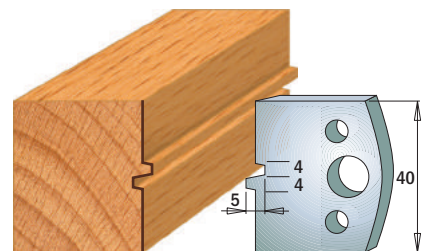

Pair of knives **690.074**
Pair of limiters **691.074**

NOTE: all knives & limiters available only in pairs

Drawings are 1:2 scale

Dimensions in mm.

Profile Knives and Limiters

Cutting Length=40mm Thickness=4mm

Pack Qty. 10



SP

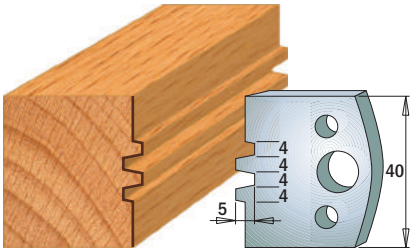

Pair of knives **690.075**
Pair of limiters **691.075**

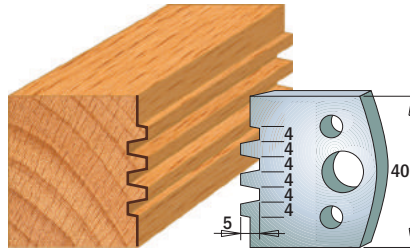

Pair of knives **690.076**
Pair of limiters **691.076**

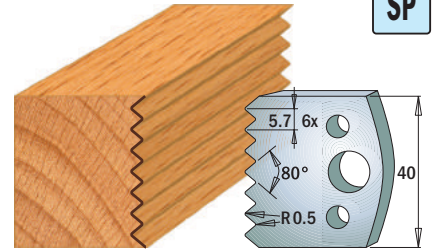

Pair of knives **690.077**
Pair of limiters **691.077**

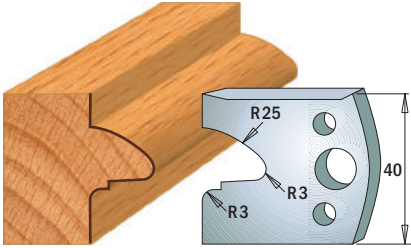

Pair of knives **690.078**
Pair of limiters **691.078**

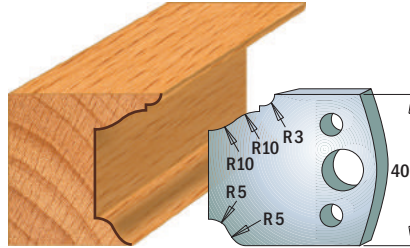

Pair of knives **690.079**
Pair of limiters **691.079**

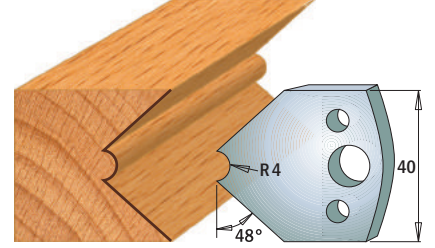

Pair of knives **690.080**
Pair of limiters **691.080**

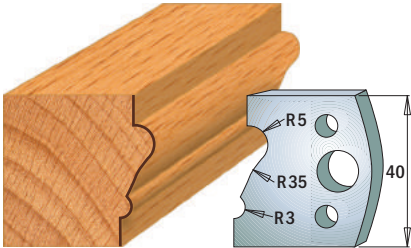

Pair of knives **690.081**
Pair of limiters **691.081**

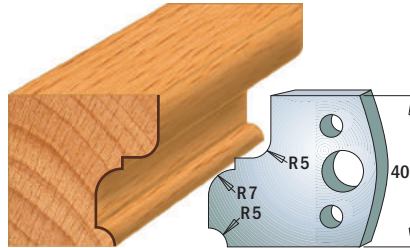

Pair of knives **690.082**
Pair of limiters **691.082**

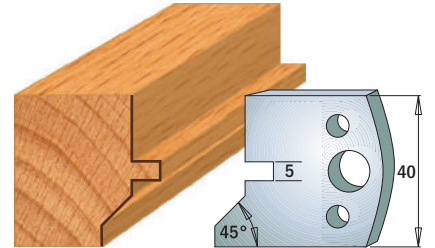

Pair of knives **690.083**
Pair of limiters **691.083**

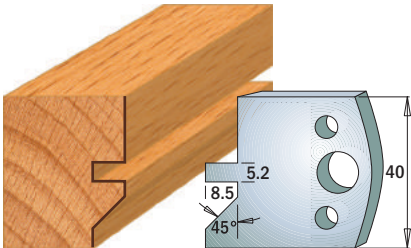

Pair of knives **690.084**
Pair of limiters **691.084**

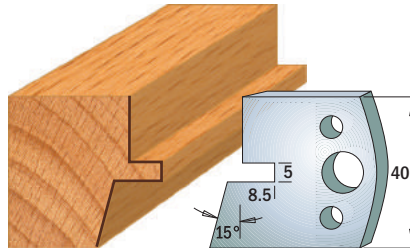

Pair of knives **690.085**
Pair of limiters **691.085**

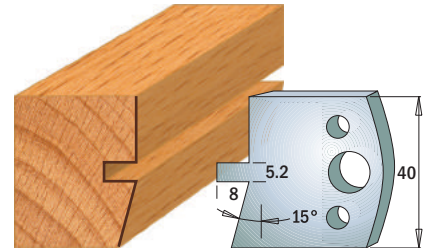

Pair of knives **690.086**
Pair of limiters **691.086**

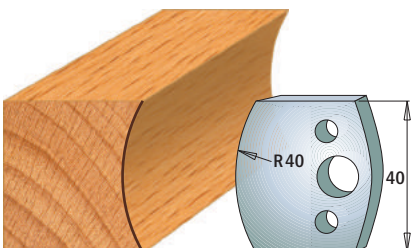

Pair of knives **690.087**
Pair of limiters **691.087**

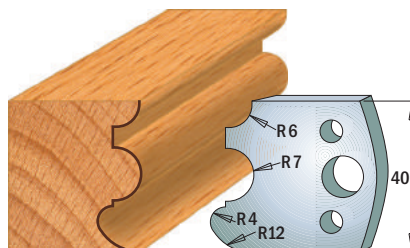

Pair of knives **690.088**
Pair of limiters **691.088**

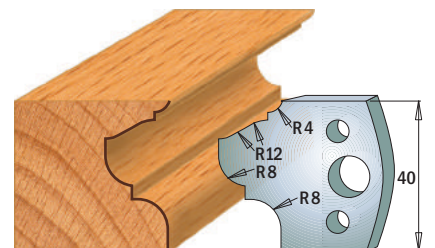

Pair of knives **690.089**
Pair of limiters **691.089**

NOTE: all knives & limiters available only in pairs

Drawings are 1:2 scale

Dimensions in mm.

Profile Knives and Limiters

Cutting Length=40mm Thickness=4mm

Pack Qty. 10



SP

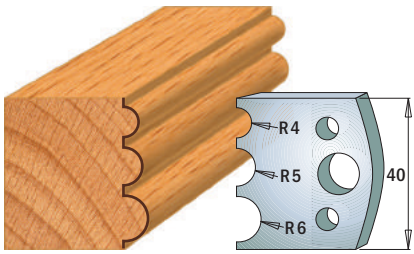

Pair of knives **690.090**
Pair of limiters **691.090**

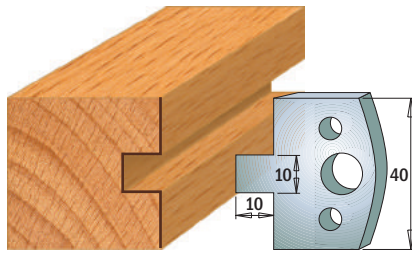

Pair of knives **690.091**
Pair of limiters **691.091**

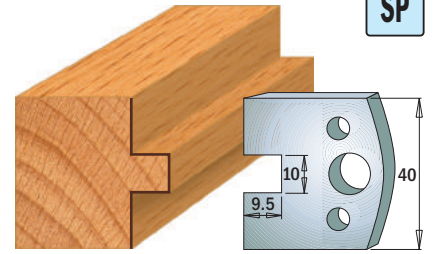

Pair of knives **690.092**
Pair of limiters **691.092**

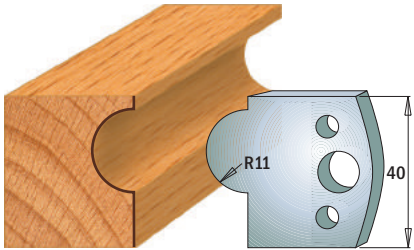

Pair of knives **690.093**
Pair of limiters **691.093**

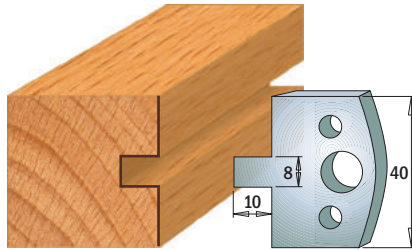

Pair of knives **690.094**
Pair of limiters **691.094**

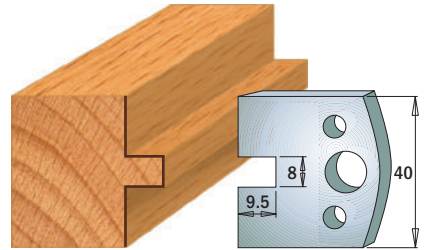

Pair of knives **690.095**
Pair of limiters **691.095**

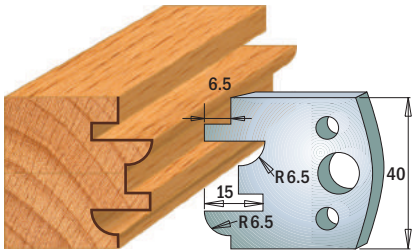

Pair of knives **690.096**
Pair of limiters **691.096**

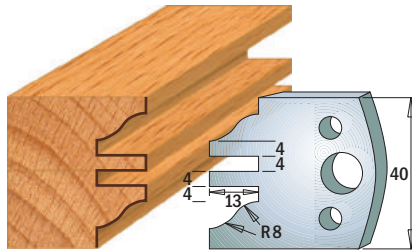

Pair of knives **690.097**
Pair of limiters **691.097**

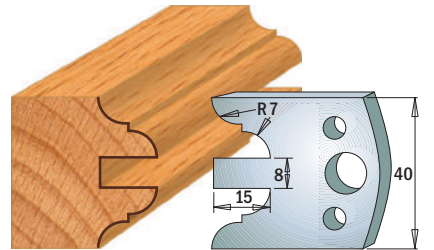

Pair of knives **690.098**
Pair of limiters **691.098**

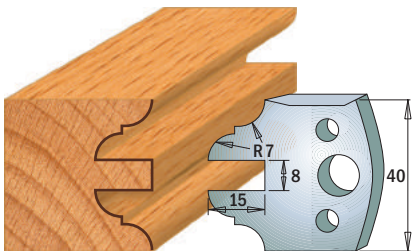

Pair of knives **690.099**
Pair of limiters **691.099**

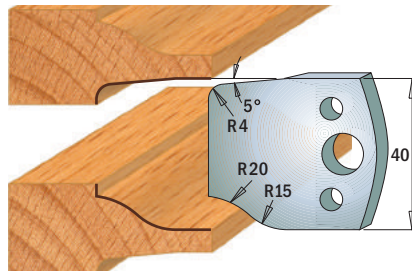

Pair of knives **690.100**
Pair of limiters **691.100**

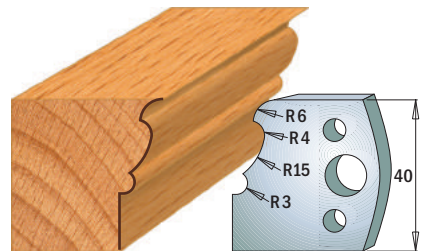

Pair of knives **690.101**
Pair of limiters **691.101**

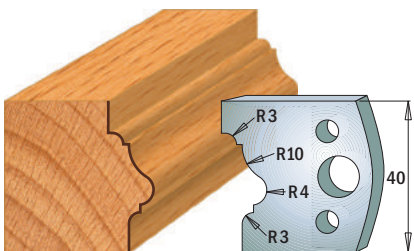

Pair of knives **690.102**
Pair of limiters **691.102**

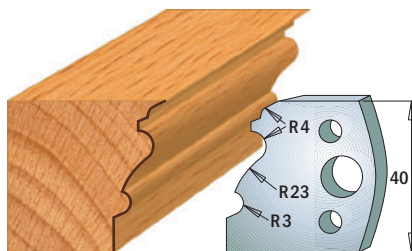

Pair of knives **690.103**
Pair of limiters **691.103**

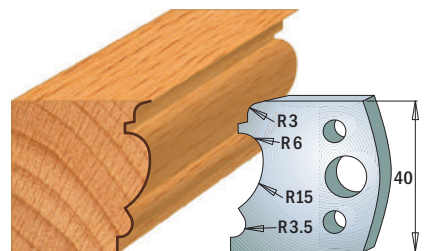

Pair of knives **690.104**
Pair of limiters **691.104**

NOTE: all knives & limiters available only in pairs

Drawings are 1:2 scale

Dimensions in mm.

Profile Knives and Limiters

Cutting Length=40mm Thickness=4mm

Pack Qty. 10



SP

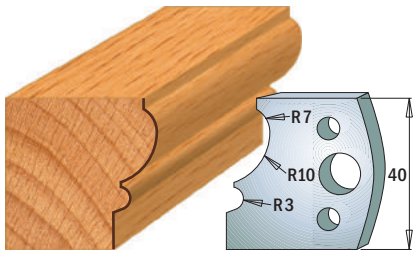

Pair of knives **690.105**
Pair of limiters **691.105**

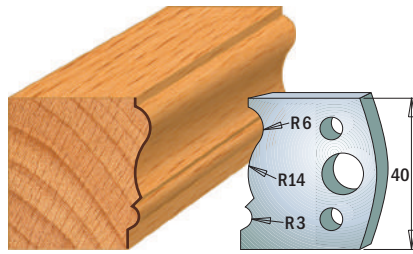

Pair of knives **690.106**
Pair of limiters **691.106**

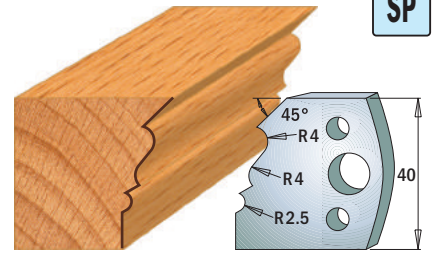

Pair of knives **690.107**
Pair of limiters **691.107**

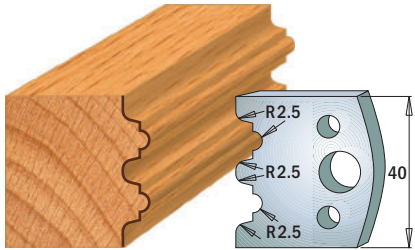

Pair of knives **690.108**
Pair of limiters **691.108**

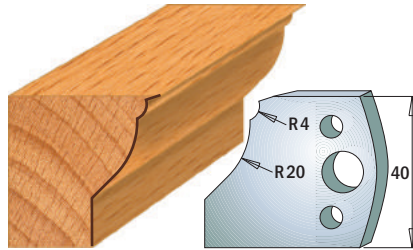

Pair of knives **690.109**
Pair of limiters **691.109**

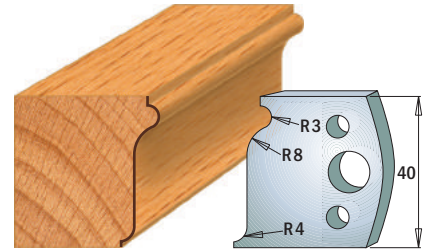

Pair of knives **690.110**
Pair of limiters **691.110**

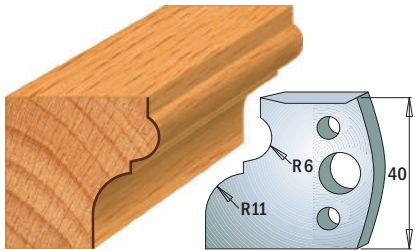

Pair of knives **690.111**
Pair of limiters **691.111**

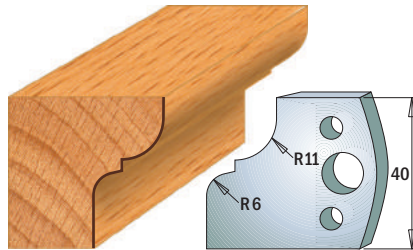

Pair of knives **690.112**
Pair of limiters **691.112**

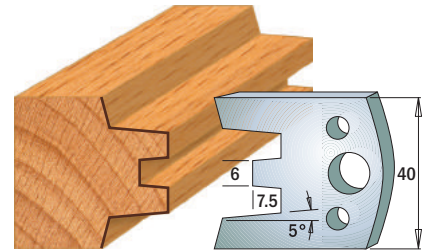

Pair of knives **690.113**
Pair of limiters **691.113**

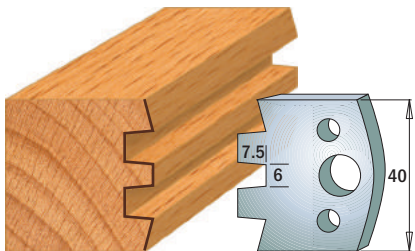

Pair of knives **690.114**
Pair of limiters **691.114**

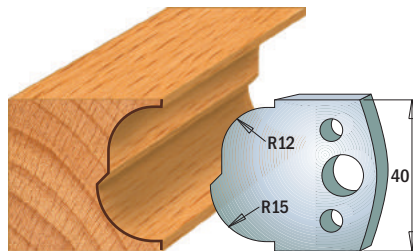

Pair of knives **690.115**
Pair of limiters **691.115**

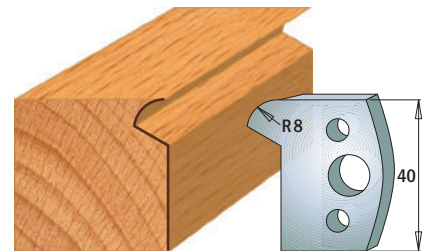

Pair of knives **690.116**
Pair of limiters **691.116**

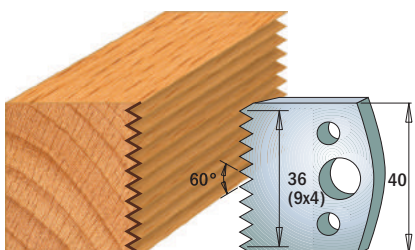

Pair of knives **690.117**
Pair of limiters **691.117**

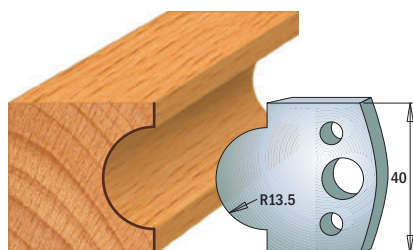

Pair of knives **690.118**
Pair of limiters **691.118**

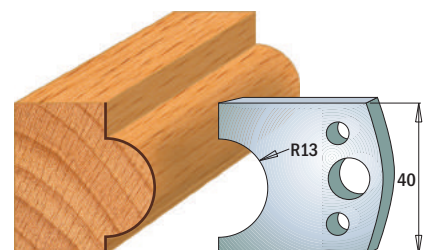

Pair of knives **690.119**
Pair of limiters **691.119**

NOTE: all knives & limiters available only in pairs

Drawings are 1:2 scale

Dimensions in mm.

Profile Knives and Limiters

Cutting Length=40mm Thickness=4mm

Pack Qty. 10



SP

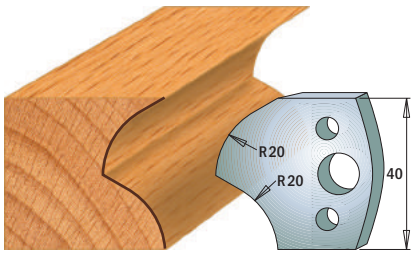

Pair of knives **690.120**
Pair of limiters **691.120**

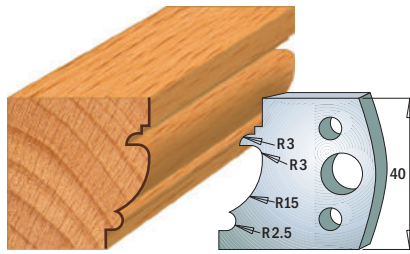

Pair of knives **690.121**
Pair of limiters **691.121**

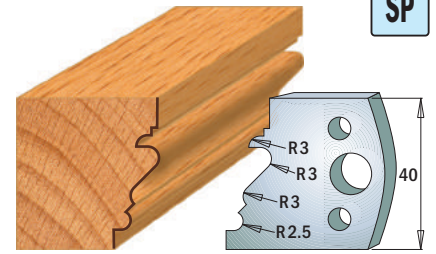

Pair of knives **690.122**
Pair of limiters **691.122**

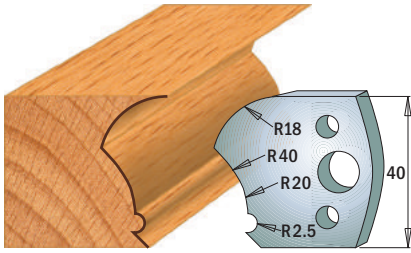

Pair of knives **690.123**
Pair of limiters **691.123**

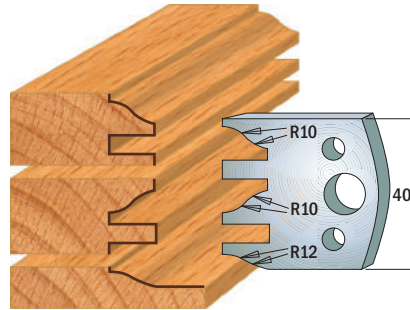

Pair of knives **690.124**
Pair of limiters **691.124**

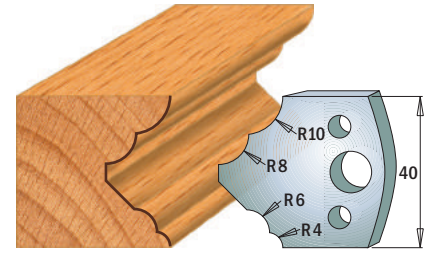

Pair of knives **690.125**
Pair of limiters **691.125**

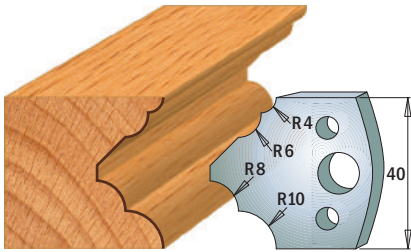

Pair of knives **690.126**
Pair of limiters **691.126**

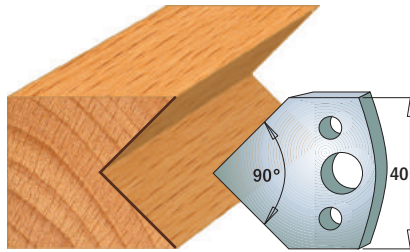

Pair of knives **690.127**
Pair of limiters **691.127**

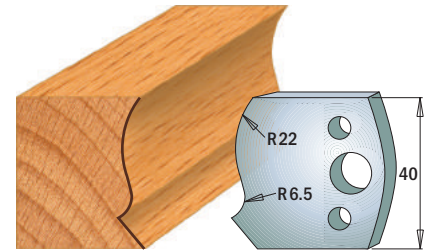

Pair of knives **690.128**
Pair of limiters **691.128**

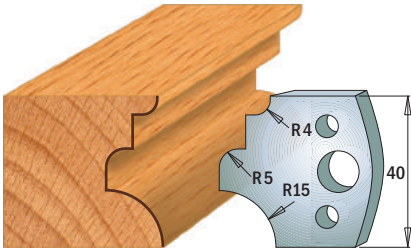

Pair of knives **690.129**
Pair of limiters **691.129**

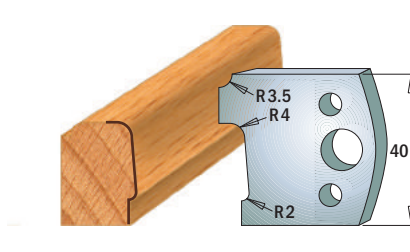

Pair of knives **690.130**
Pair of limiters **691.130**

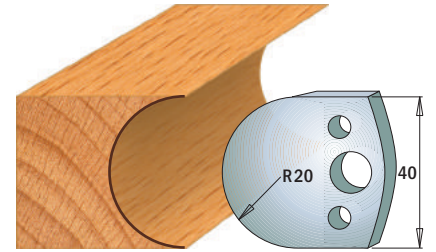

Pair of knives **690.131**
Pair of limiters **691.131**

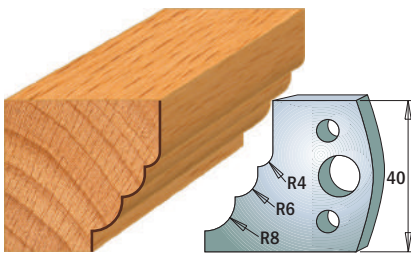

Pair of knives **690.132**
Pair of limiters **691.132**

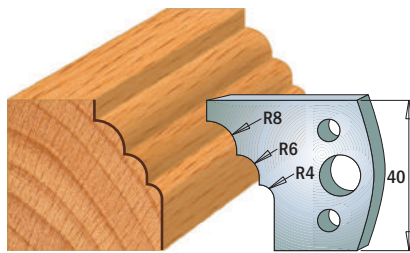

Pair of knives **690.133**
Pair of limiters **691.133**

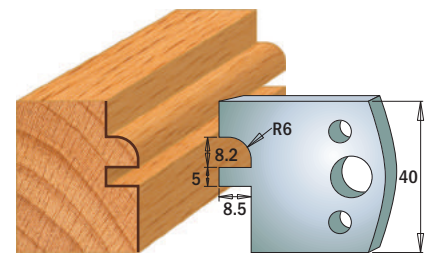

Pair of knives **690.134**
Pair of limiters **691.134**

NOTE: all knives & limiters available only in pairs

Drawings are 1:2 scale

Dimensions in mm.

SP

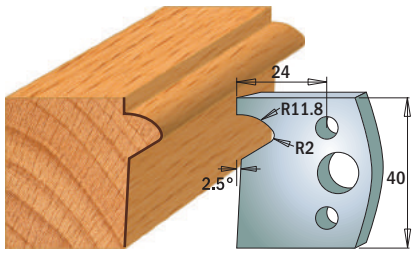

Pair of knives **690.135**
Pair of limiters **691.135**

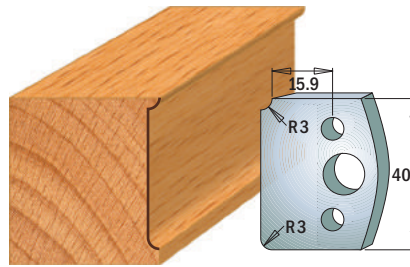

Pair of knives **690.170**
Pair of limiters **691.170**

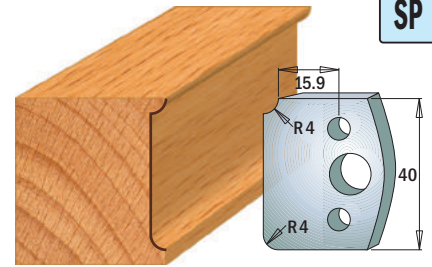

Pair of knives **690.171**
Pair of limiters **691.171**

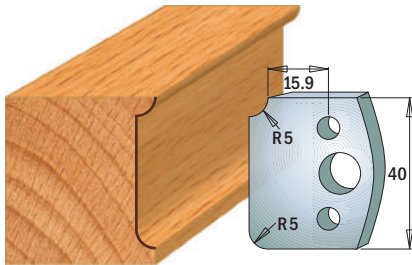

Pair of knives **690.172**
Pair of limiters **691.172**

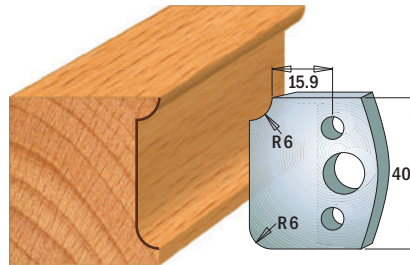

Pair of knives **690.173**
Pair of limiters **691.173**

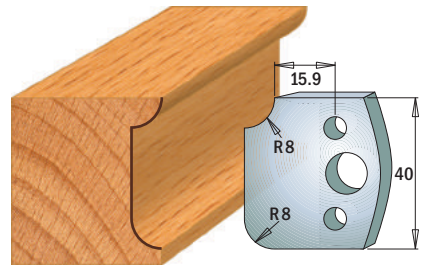

Pair of knives **690.174**
Pair of limiters **691.174**

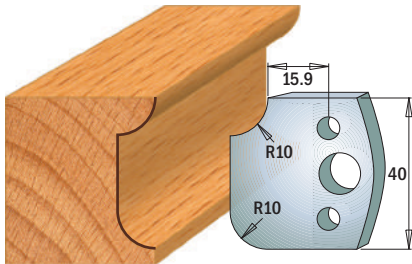

Pair of knives **690.175**
Pair of limiters **691.175**

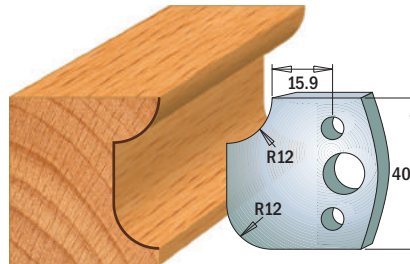

Pair of knives **690.176**
Pair of limiters **691.176**

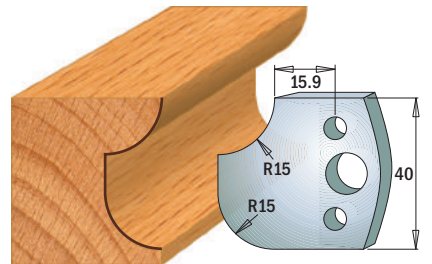

Pair of knives **690.177**
Pair of limiters **691.177**

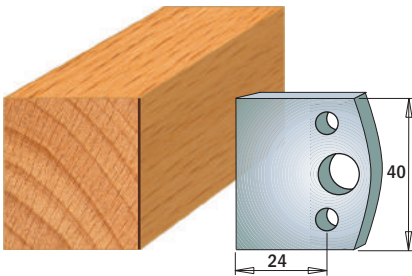

Pair of knives **690.192**
Pair of limiters **691.192**

Profile Knives and Limiters

Cutting Length=50mm
Thickness=4mm
Pack Qty. 10

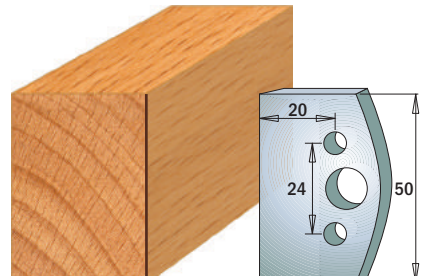

Pair of knives **690.500**
Pair of limiters **691.500**

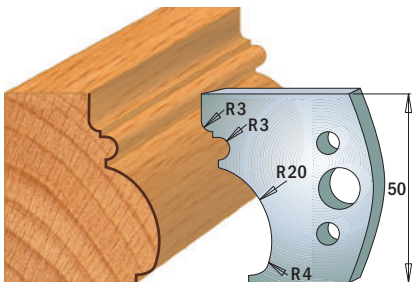

Pair of knives **690.501**
Pair of limiters **691.501**

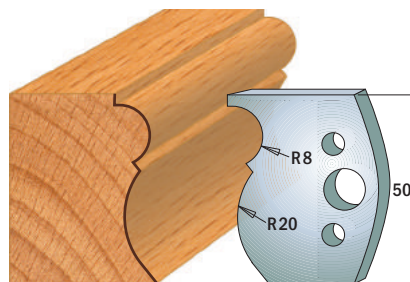

Pair of knives **690.502**
Pair of limiters **691.502**

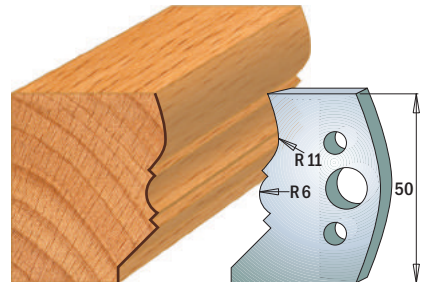

Pair of knives **690.503**
Pair of limiters **691.503**

NOTE: all knives & limiters available only in pairs

Drawings are 1:2 scale

Dimensions in mm.

Profile Knives and Limiters

Cutting Length=50mm Thickness=4mm

Pack Qty. 10



SP

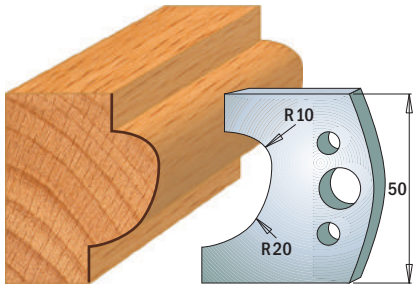

Pair of knives **690.504**
Pair of limiters **691.504**

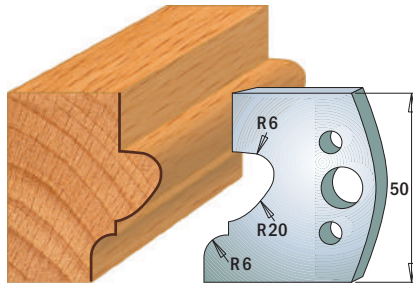

Pair of knives **690.505**
Pair of limiters **691.505**

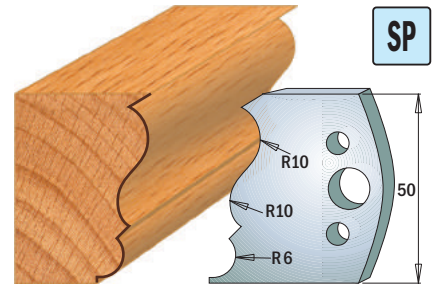

Pair of knives **690.506**
Pair of limiters **691.506**

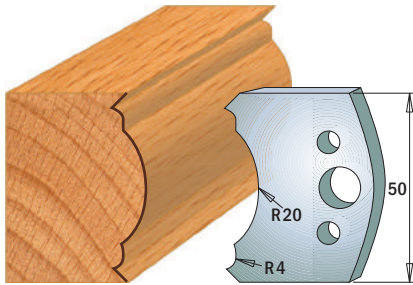

Pair of knives **690.507**
Pair of limiters **691.507**

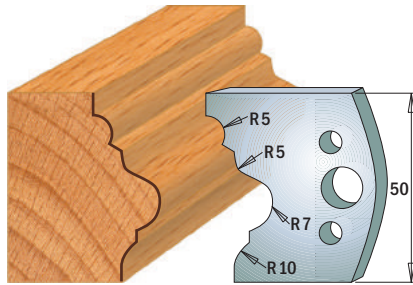

Pair of knives **690.508**
Pair of limiters **691.508**

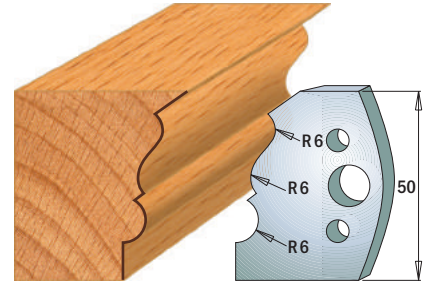

Pair of knives **690.509**
Pair of limiters **691.509**

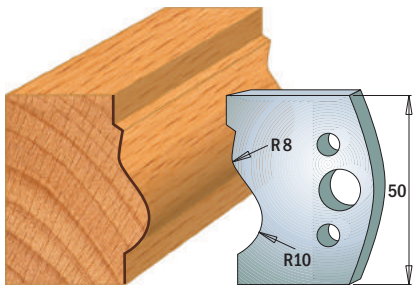

Pair of knives **690.510**
Pair of limiters **691.510**

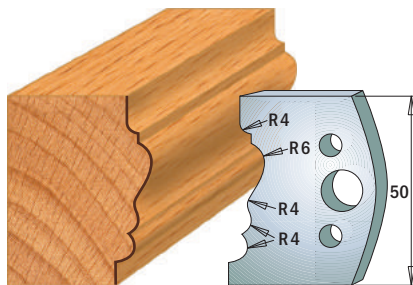

Pair of knives **690.511**
Pair of limiters **691.511**

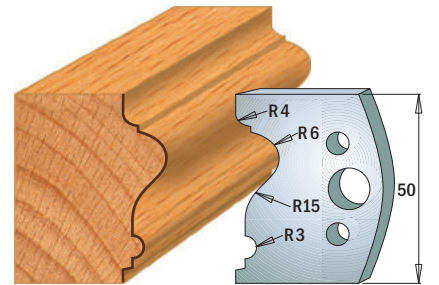

Pair of knives **690.512**
Pair of limiters **691.512**

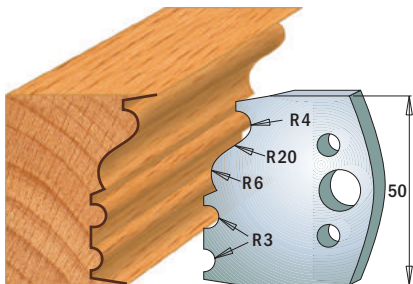

Pair of knives **690.513**
Pair of limiters **691.513**

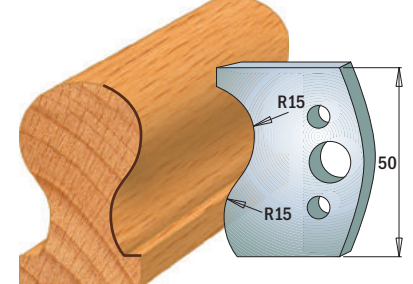

Pair of knives **690.514**
Pair of limiters **691.514**

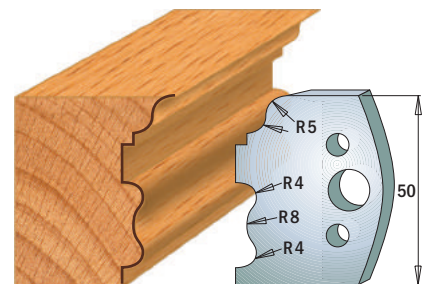

Pair of knives **690.515**
Pair of limiters **691.515**

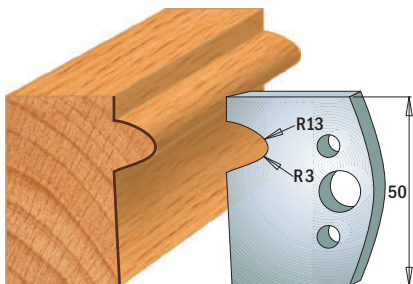

Pair of knives **690.516**
Pair of limiters **691.516**

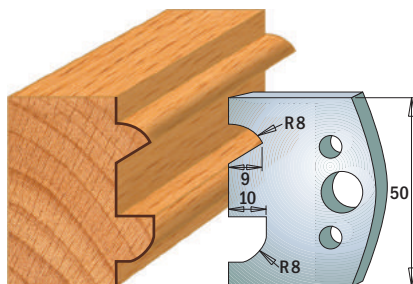

Pair of knives **690.517**
Pair of limiters **691.517**

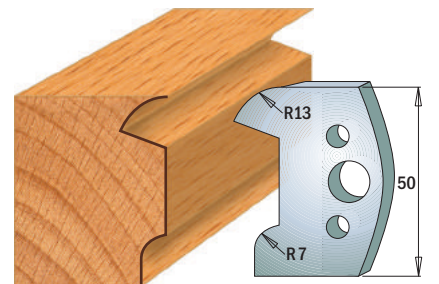

Pair of knives **690.518**
Pair of limiters **691.518**

NOTE: all knives & limiters available only in pairs

Drawings are 1:2 scale

Dimensions in mm.

Profile Knives and Limiters

Cutting Length=50mm Thickness=4mm

Pack Qty. 10

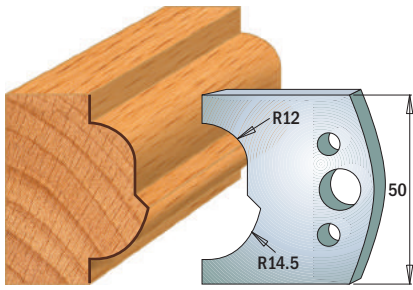

Pair of knives **690.519**
Pair of limiters **691.519**

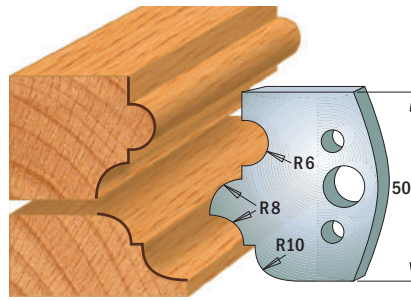

Pair of knives **690.520**
Pair of limiters **691.520**

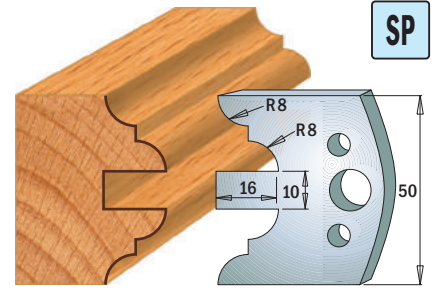

Pair of knives **690.522**
Pair of limiters **691.522**

SP

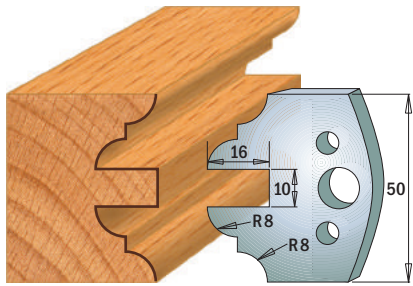

Pair of knives **690.523**
Pair of limiters **691.523**

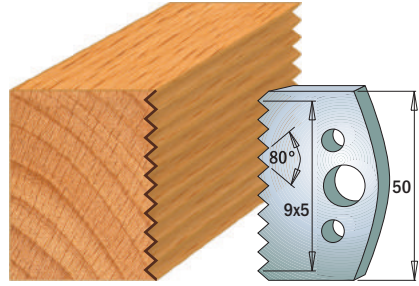

Pair of knives **690.524**
Pair of limiters **691.524**

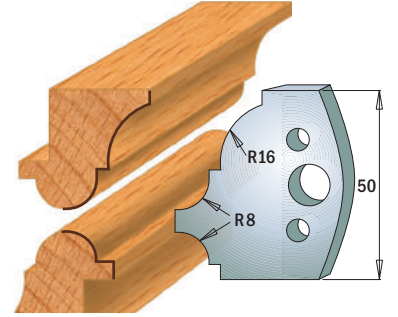

Pair of knives **690.541**
Pair of limiters **691.541**

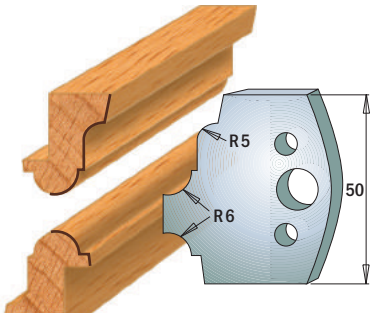

Pair of knives **690.542**
Pair of limiters **691.542**

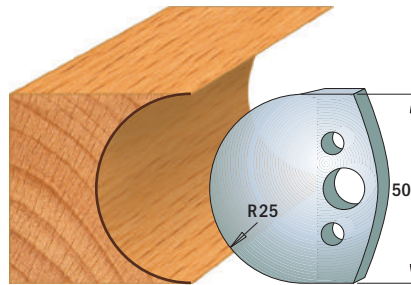

Pair of knives **690.543**
Pair of limiters **691.543**

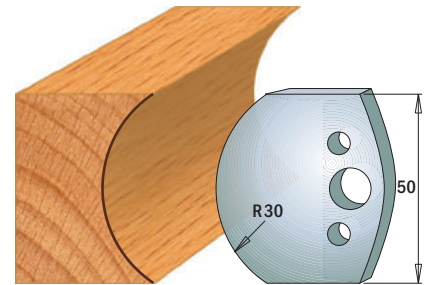

Pair of knives **690.544**
Pair of limiters **691.544**

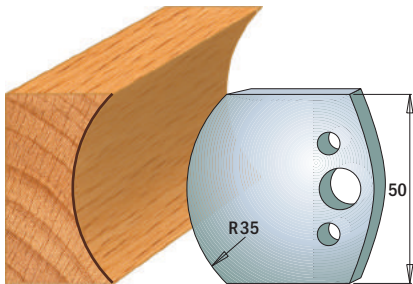

Pair of knives **690.545**
Pair of limiters **691.545**

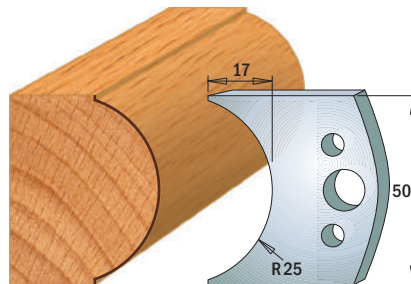

Pair of knives **690.546**
Pair of limiters **691.546**

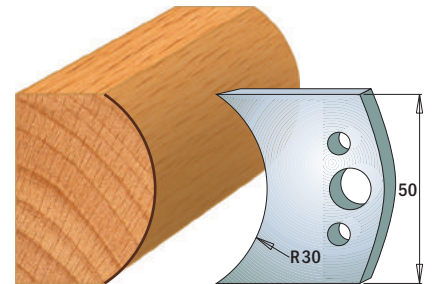

Pair of knives **690.547**
Pair of limiters **691.547**

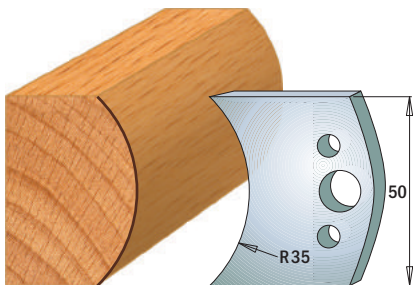

Pair of knives **690.548**
Pair of limiters **691.548**

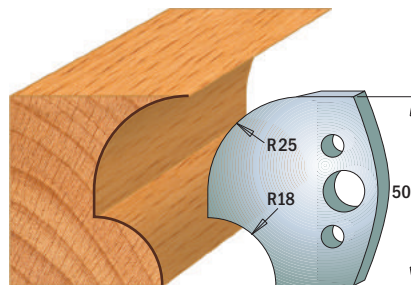

Pair of knives **690.549**
Pair of limiters **691.549**

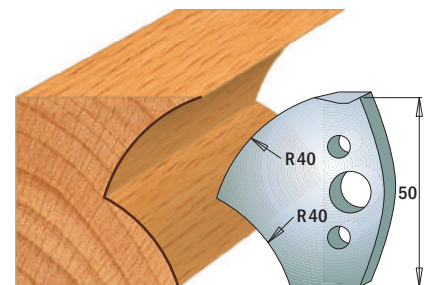

Pair of knives **690.550**
Pair of limiters **691.550**

NOTE: all knives & limiters available only in pairs

Drawings are 1:2 scale

Dimensions in mm.

Profile Knives and Limiters

Cutting Length=50mm Thickness=4mm

Pack Qty. 10



SP

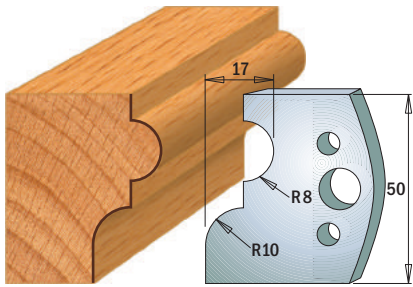

Pair of knives **690.551**
Pair of limiters **691.551**

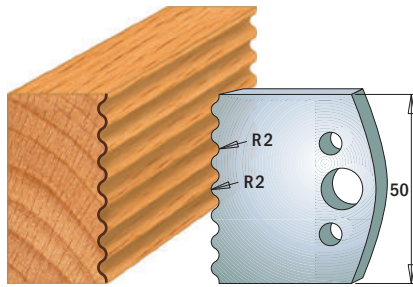

Pair of knives **690.552**
Pair of limiters **691.552**

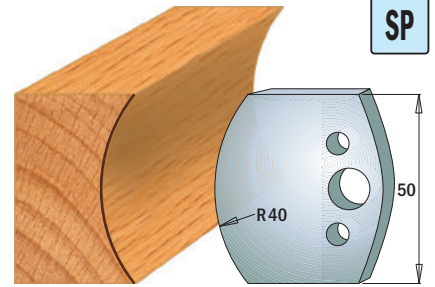

Pair of knives **690.553**
Pair of limiters **691.553**

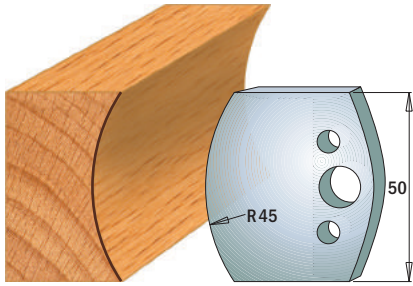

Pair of knives **690.554**
Pair of limiters **691.554**

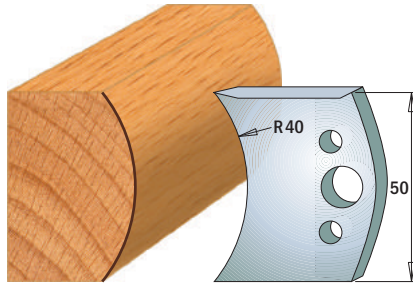

Pair of knives **690.555**
Pair of limiters **691.555**

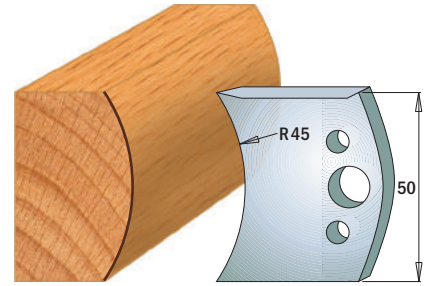

Pair of knives **690.556**
Pair of limiters **691.556**

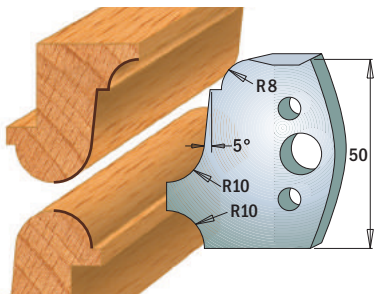

Pair of knives **690.557**
Pair of limiters **691.557**

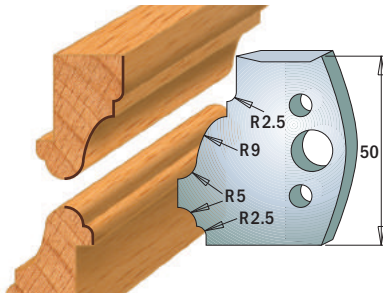

Pair of knives **690.558**
Pair of limiters **691.558**

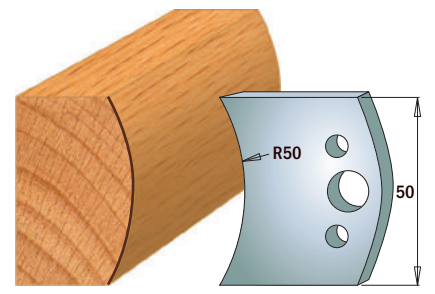

Pair of knives **690.559**
Pair of limiters **691.559**

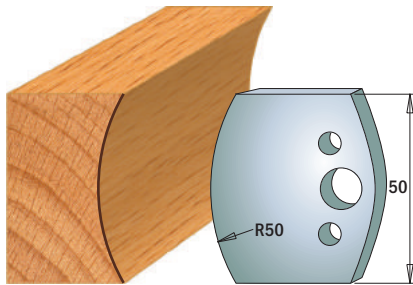

Pair of knives **690.560**
Pair of limiters **691.560**

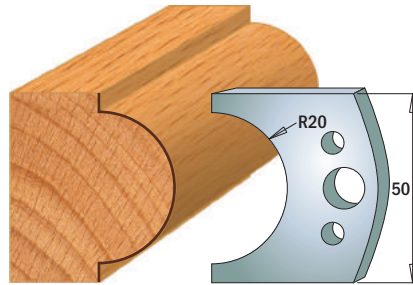

Pair of knives **690.561**
Pair of limiters **691.561**

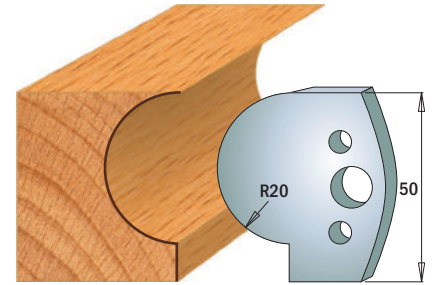

Pair of knives **690.562**
Pair of limiters **691.562**

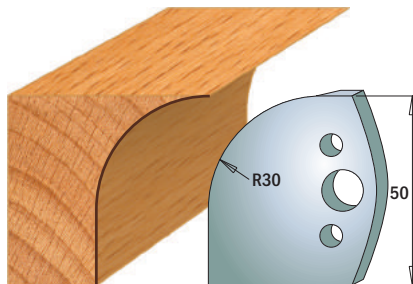

Pair of knives **690.563**
Pair of limiters **691.563**

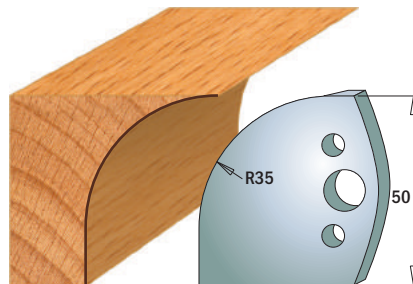

Pair of knives **690.564**
Pair of limiters **691.564**

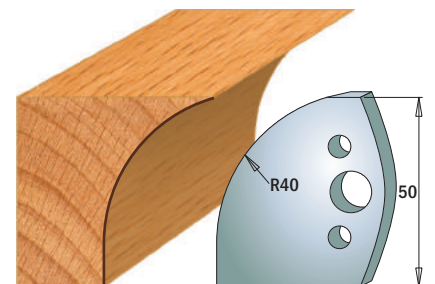

Pair of knives **690.565**
Pair of limiters **691.565**

NOTE: all knives & limiters available only in pairs

Drawings are 1:2 scale

Dimensions in mm.

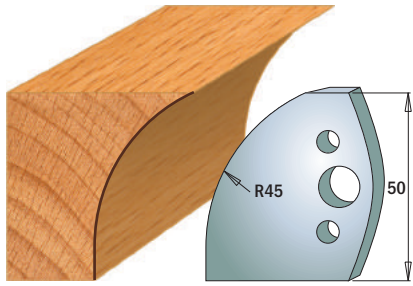

Pair of knives **690.566**
Pair of limiters **691.566**

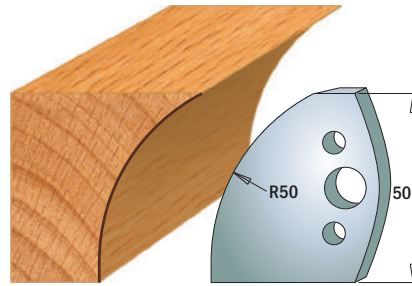

Pair of knives **690.567**
Pair of limiters **691.567**

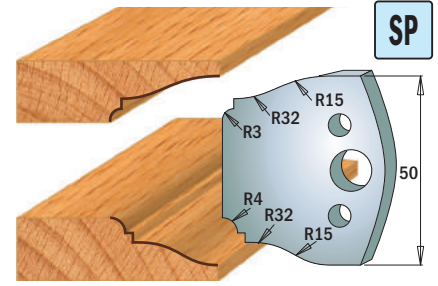

Pair of knives **690.568**
Pair of limiters **691.568**

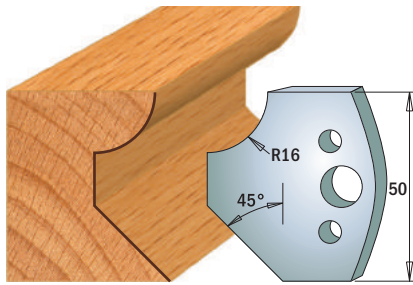

Pair of knives **690.569**
Pair of limiters **691.569**

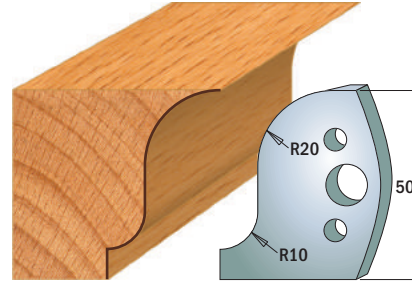

Pair of knives **690.570**
Pair of limiters **691.570**

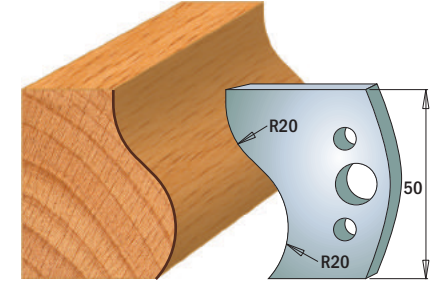

Pair of knives **690.571**
Pair of limiters **691.571**

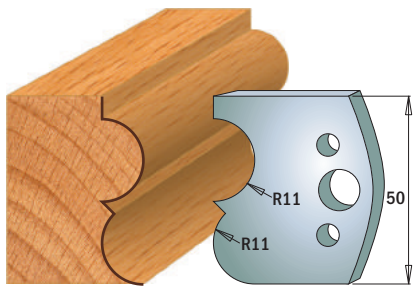

Pair of knives **690.572**
Pair of limiters **691.572**

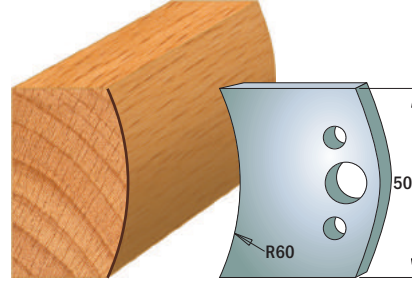

Pair of knives **690.573**
Pair of limiters **691.573**

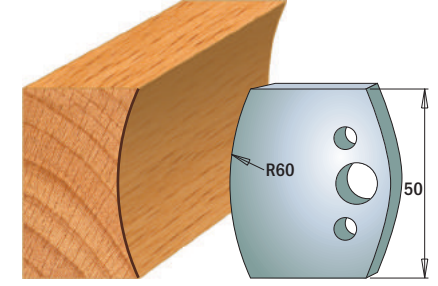

Pair of knives **690.574**
Pair of limiters **691.574**

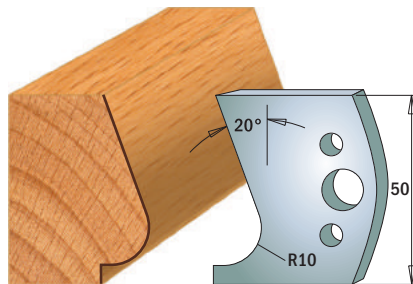

Pair of knives **690.575**
Pair of limiters **691.575**

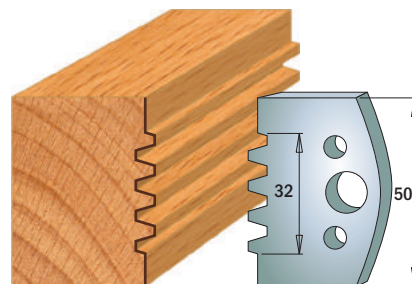

Pair of knives **690.576**
Pair of limiters **691.576**

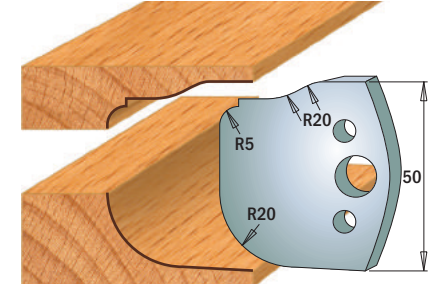

Pair of knives **690.577**
Pair of limiters **691.577**

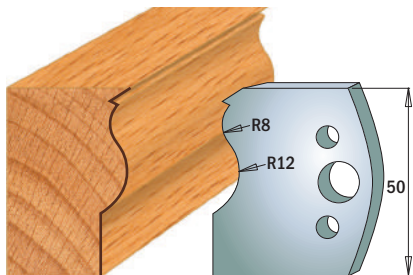

Pair of knives **690.578**
Pair of limiters **691.578**

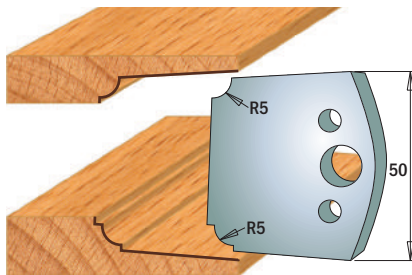

Pair of knives **690.579**
Pair of limiters **691.579**

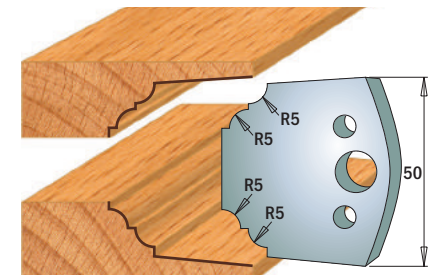

Pair of knives **690.580**
Pair of limiters **691.580**

NOTE: all knives & limiters available only in pairs

Drawings are 1:2 scale

Dimensions in mm.

Blank Knives & Limiters (to be sharpened)

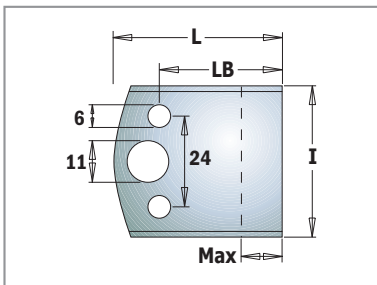

690-691

SP HSS

DESCRIPTION	I mm	LB mm	L mm	Max mm	PACK QTY.	ORDER NO. SP	ORDER NO. HSS
Pair of knives	40	32,5	44,5	18	10	690.193	690.193H
Pair of knives	50	34	46	20	10	690.599	690.599H
Pair of limiters	38	16	28	2	10	691.190	
Pair of limiters	38	24	36	10	10	691.192	
Pair of limiters	38	32,5	44,5	18	10		691.193
Pair of limiters	48	34	46	20	10	691.599	

Pair of Bore Reducers

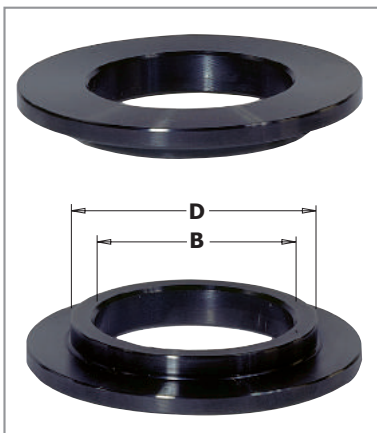

699

D mm	B mm	PACK QTY.	ORDER NO.	D mm	B mm	PACK QTY.	ORDER NO.
19,05	12,7	10	699.019.13	35	32	10	699.035.32
25,4	19,05	10	699.026.19	40	30	10	699.040.30
30	19,05	10	699.030.19	40	32	10	699.040.32
30	25,4	10	699.030.26	40	35	10	699.040.35
31,75	19,05	10	699.031.19	50	30	1	699.050.30
31,75	25,4	10	699.031.26	50	32	1	699.050.32
31,75	30	10	699.031.30	50	35	1	699.050.35
35	30	10	699.035.30	50	40	1	699.050.40
35	31,75	10	699.035.31				

For use only paired.

Chucks & "ER20" Collets for Spindle Moulder Machine

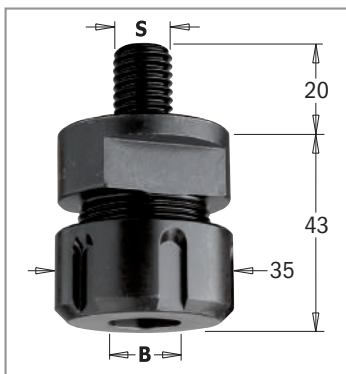

796

S mm	B mm	L mm	PACK QTY.	ORDER NO.
M12x1,75	3 ~ 12,7	43	10	796.122.00
M14x2	3 ~ 12,7	43	10	796.142.00
M16x2	3 ~ 12,7	43	10	796.162.00

Spare parts 992.483.03 M25x1,5mm clamping nut
991.483.00 "ER20" key

TECHNICAL DETAILS:

Super strength steel.
Precisely machined for accuracy.

Collet not included.

"ER20" Precision Collets for 796.122/142/162 Items

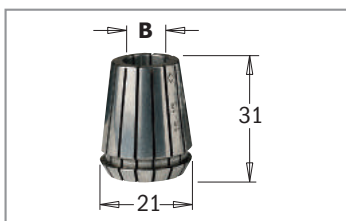

184

B mm	PACK QTY.	ORDER NO.	B mm	PACK QTY.	ORDER NO.
2	10	184.020.20	8	10	184.080.20
3	10	184.030.20	9	10	184.090.20
4	10	184.040.20	10	10	184.100.20
5	10	184.050.20	11	10	184.110.20
6	10	184.060.20	12	10	184.120.20
6,35	10	184.064.20	12,7	10	184.127.20
7	10	184.070.20	13	10	184.130.20

HS Corrugated Back Moulder Knives

HSS

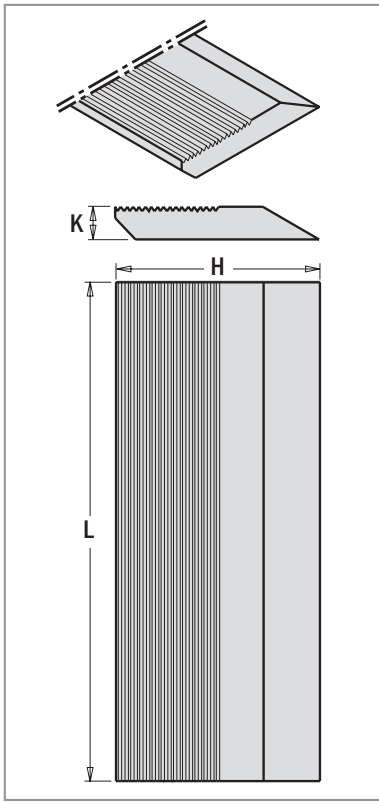

793

L mm	H mm	K mm	ORDER NO. pieces for each set	PACK Qty.	ORDER NO. HSS
40 x	50 x	8	4	1	793.040.50
40 x	60 x	8	4	1	793.040.60
40 x	70 x	8	4	1	793.040.70
60 x	50 x	8	4	1	793.060.50
60 x	60 x	8	4	1	793.060.60
60 x	70 x	8	4	1	793.060.70
80 x	50 x	8	4	1	793.080.50
80 x	60 x	8	4	1	793.080.60
80 x	70 x	8	4	1	793.080.70
100 x	50 x	8	4	1	793.100.50
100 x	60 x	8	4	1	793.100.60
100 x	70 x	8	4	1	793.100.70
120 x	50 x	8	4	1	793.120.50
120 x	60 x	8	4	1	793.120.60
120 x	70 x	8	4	1	793.120.70
130 x	60 x	8	4	1	793.130.60
130 x	70 x	8	4	1	793.130.70
650 x	40 x	8	4	1	793.650.40
650 x	50 x	8	4	1	793.650.50
650 x	60 x	8	4	1	793.650.60
650 x	70 x	8	4	1	793.650.70

REMARK: special dimensions available on request.

TECHNICAL DETAILS:

Corrugated back moulder knives for profile cutter heads with precise positioning, angle 60°, pitch 1,6mm.



IN QUADROPACK PACKAGING
4 KNIVES FOR EACH SET

MATERIAL	HSS
Dry softwood	●
Wet softwood	●
Dry hardwood	●
Wet hardwood	○

- Suitable
- Party suitable

Set of 2 Magnetic Knife Setting Jigs



Insert your knives into the tool holders and align them perfectly with this set! Perfect micro adjustments on will guarantee excellent cutting performance!

1. MAGNETIC STOP
2. JOINTS WITH MAGNETIC CONNECTORS
3. LOCK SCREW

CMT792

2 setup possibilities

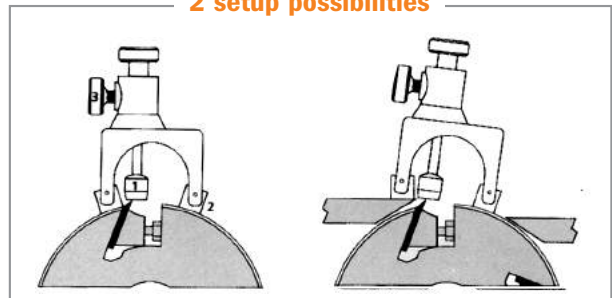

Positioning on the tool holder body with detection of the knife position.

Direct positioning on both the planer table and the tool holder body with detection of the knife position.

DESCRIPTION	PACK Qty.	ORDER NO.
Set of 2 magnetic knife setting jigs	25	CMT792

Supplied in a solid wooden box

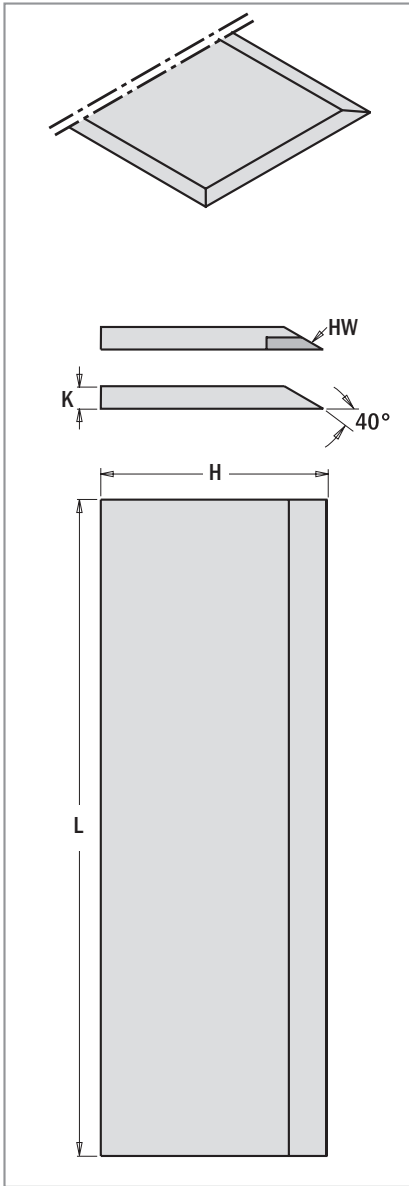

IN QUADROPACK PACKAGING
2 KNIVES FOR EACH SET

792

L mm	H mm	K mm	KNIVES pieces for each set	PACK QTY.	ORDER NO. SP	ORDER NO. HSS	ORDER NO. HW
120 x 30 x 3	30	3	2	1		792.120.30	
130 x 30 x 3	30	3	2	1	792.131.30	792.130.30	792.132.30
150 x 30 x 3	30	3	2	1		792.150.30	
180 x 30 x 3	30	3	2	1	792.181.30	792.180.30	792.182.30
200 x 30 x 3	30	3	2	1	792.201.30	792.200.30	
210 x 30 x 3	30	3	2	1	792.211.30	792.210.30	
230 x 30 x 3	30	3	2	1	792.231.30	792.230.30	792.232.30
250 x 30 x 3	30	3	2	1	792.251.30	792.250.30	792.252.30
260 x 30 x 3	30	3	2	1	792.261.30	792.260.30	792.262.30
300 x 30 x 3	30	3	2	1	792.301.30	792.300.30	792.302.30
310 x 30 x 3	30	3	2	1	792.311.30	792.310.30	792.312.30
350 x 30 x 3	30	3	2	1	792.351.30	792.350.30	792.352.30
400 x 30 x 3	30	3	2	1	792.401.30	792.400.30	792.402.30
410 x 30 x 3	30	3	2	1	792.411.30	792.410.30	792.412.30
430 x 30 x 3	30	3	2	1	792.431.30	792.430.30	792.432.30
450 x 30 x 3	30	3	2	1	792.451.30	792.450.30	792.452.30
500 x 30 x 3	30	3	2	1	792.501.30	792.500.30	792.502.30
510 x 30 x 3	30	3	2	1	792.511.30	792.510.30	792.512.30
520 x 30 x 3	30	3	2	1	792.521.30	792.520.30	792.522.30
530 x 30 x 3	30	3	2	1	792.531.30	792.530.30	792.532.30
600 x 30 x 3	30	3	2	1	792.601.30	792.600.30	792.602.30
610 x 30 x 3	30	3	2	1	792.611.30	792.610.30	792.612.30
630 x 30 x 3	30	3	2	1	792.631.30	792.630.30	792.632.30
640 x 30 x 3	30	3	2	1		792.640.30	
710 x 30 x 3	30	3	2	1		792.710.30	
810 x 30 x 3	30	3	2	1	792.811.30	792.810.30	792.812.30
1050 x 30 x 3	30	3	2	1	792.998.30	792.997.30	792.999.30
300 x 35 x 3	35	3	2	1		792.300.35	
310 x 35 x 3	35	3	2	1	792.311.35		
350 x 35 x 3	35	3	2	1	792.351.35	792.350.35	
400 x 35 x 3	35	3	2	1	792.401.35	792.400.35	
410 x 35 x 3	35	3	2	1	792.411.35	792.410.35	
430 x 35 x 3	35	3	2	1		792.430.35	
450 x 35 x 3	35	3	2	1	792.451.35	792.450.35	
500 x 35 x 3	35	3	2	1	792.501.35	792.500.35	
510 x 35 x 3	35	3	2	1	792.511.35	792.510.35	
520 x 35 x 3	35	3	2	1	792.521.35	792.520.35	
530 x 35 x 3	35	3	2	1	792.531.35	792.530.35	
550 x 35 x 3	35	3	2	1	792.551.35	792.550.35	
600 x 35 x 3	35	3	2	1	792.601.35	792.600.35	
610 x 35 x 3	35	3	2	1	792.611.35	792.610.35	
630 x 35 x 3	35	3	2	1	792.631.35	792.630.35	
650 x 35 x 3	35	3	2	1	792.651.35	792.650.35	
710 x 35 x 3	35	3	2	1		792.710.35	
810 x 35 x 3	35	3	2	1	792.811.35	792.810.35	
820 x 35 x 3	35	3	2	1	792.821.35		
1050 x 35 x 3	35	3	2	1	792.998.35	792.997.35	

REMARK: special dimensions available on request.
The mirror finish on HW knives produces both razor sharp and extremely durable cutting edges.



MATERIAL	SP	HSS	HW
Dry softwood	○	●	
Wet softwood	○	○	
Dry hardwood	○	●	●
Wet hardwood	○	●	○
Chipboard			○
MDF			○
Glulam		○	●
Solid surface			○

- Suitable
- Partly suitable



TERSA

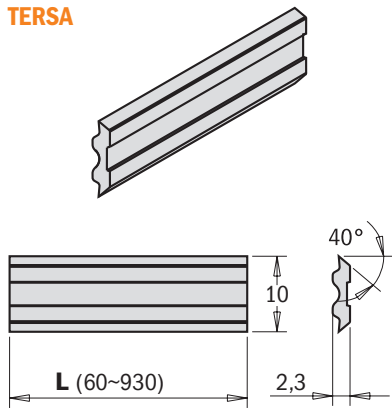

**CENTROSTAR
CENTROFIX
QUICKFIX**

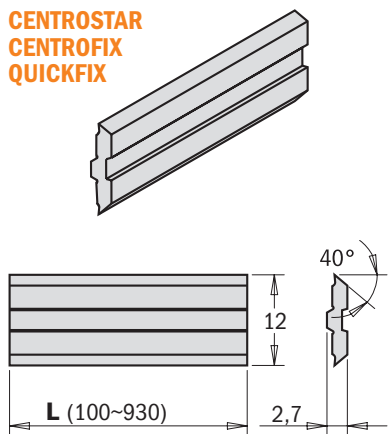

CENTROLOCK

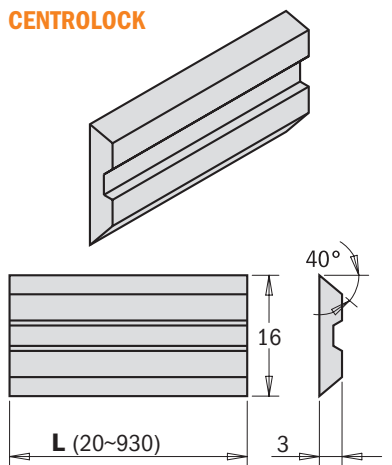

2 KNIVES FOR EACH SET

795

TERSA				CENTROSTAR, CENTROFIX, QUICKFIX				CENTROLOCK			
L	H	K	ORDER NO.	L	H	K	ORDER NO.	L	H	K	ORDER NO.
mm	mm	mm		mm	mm	mm		mm	mm	mm	
80 x 10 x 2,3			795.080.10*					20 x 16 x 3			795.020.16*
100 x 10 x 2,3			795.100.10	100 x 12 x 2,7			795.100.12*	80 x 16 x 3			795.080.16*
110 x 10 x 2,3			795.110.10	110 x 12 x 2,7			795.110.12*				
120 x 10 x 2,3			795.120.10	120 x 12 x 2,7			795.120.12				
130 x 10 x 2,3			795.130.10	130 x 12 x 2,7			795.130.12	130 x 16 x 3			795.130.16
150 x 10 x 2,3			795.150.10	150 x 12 x 2,7			795.150.12	150 x 16 x 3			795.150.16
				160 x 12 x 2,7			795.160.12*				
170 x 10 x 2,3			795.170.10	170 x 12 x 2,7			795.170.12*	170 x 16 x 3			795.170.16
180 x 10 x 2,3			795.180.10	180 x 12 x 2,7			795.180.12	180 x 16 x 3			795.180.16
				190 x 12 x 2,7			795.190.12*	190 x 16 x 3			795.190.16
				200 x 12 x 2,7			795.200.12*				
210 x 10 x 2,3			795.210.10					210 x 16 x 3			795.210.16
				220 x 12 x 2,7			795.220.12*				
230 x 10 x 2,3			795.230.10	230 x 12 x 2,7			795.230.12	230 x 16 x 3			795.230.16
								235 x 16 x 3			795.235.16*
				240 x 12 x 2,7			795.240.12	240 x 16 x 3			795.240.16
250 x 10 x 2,3			795.250.10								
260 x 10 x 2,3			795.260.10					260 x 16 x 3			795.260.16
				270 x 12 x 2,7			795.270.12*	270 x 16 x 3			795.270.16
				280 x 12 x 2,7			795.280.12*				
300 x 10 x 2,3			795.300.10								
310 x 10 x 2,3			795.310.10	310 x 12 x 2,7			795.310.12	310 x 16 x 3			795.310.16
330 x 10 x 2,3			795.330.10*								
350 x 10 x 2,3			795.350.10	350 x 12 x 2,7			795.350.12*				
				360 x 12 x 2,7			795.360.12*				
400 x 10 x 2,3			795.400.10	400 x 12 x 2,7			795.400.12				
410 x 10 x 2,3			795.410.10	410 x 12 x 2,7			795.410.12				
420 x 10 x 2,3			795.420.10	420 x 12 x 2,7			795.420.12*				
430 x 10 x 2,3			795.430.10	430 x 12 x 2,7			795.430.12*				
450 x 10 x 2,3			795.450.10	450 x 12 x 2,7			795.450.12*				
500 x 10 x 2,3			795.500.10								
510 x 10 x 2,3			795.510.10	510 x 12 x 2,7			795.510.12				
520 x 10 x 2,3			795.520.10	520 x 12 x 2,7			795.520.12				
530 x 10 x 2,3			795.530.10	530 x 12 x 2,7			795.530.12*				
540 x 10 x 2,3			795.540.10								
610 x 10 x 2,3			795.610.10	610 x 12 x 2,7			795.610.12				
				620 x 12 x 2,7			795.620.12				
630 x 10 x 2,3			795.630.10	630 x 12 x 2,7			795.630.12				
635 x 10 x 2,3			795.635.10								
640 x 10 x 2,3			795.640.10	640 x 12 x 2,7			795.640.12				
650 x 10 x 2,3			795.650.10	650 x 12 x 2,7			795.650.12*				
710 x 10 x 2,3			795.710.10	710 x 12 x 2,7			795.710.12*				
				810 x 12 x 2,7			795.810.12*				
860 x 10 x 2,3			795.860.10*								
910 x 10 x 2,3			795.910.10*								
930 x 10 x 2,3			795.930.10	930 x 12 x 2,7			795.930.12*	930 x 16 x 3			795.930.16

*While supplies last

TECHNICAL DETAILS:

HPS® was specially developed for the woodworking industry. The Thyssen-Krupp heat treatment division developed a special heat treatment system in a modern vacuum oven which gives this steel its special attributes and renders it an outstanding alternative to HSS steel. The main advantages are:

- superb wear resistance
- maximum level of toughness
- resistance to softening
- easy to profile
- long lasting tested

Test result: Wood=Oak, Spinadle speed=6000 rpm, feed=24 meter/min
 = Result HPS® 17500 meters.
 = Result HSS 10000 meters.

MATERIAL	GOOD	EXCELLENT
Dry Softwood		●
Wet Softwood		●
Dry Hardwood		●
Wet Hardwood		●
Exotic Hardwood	●	

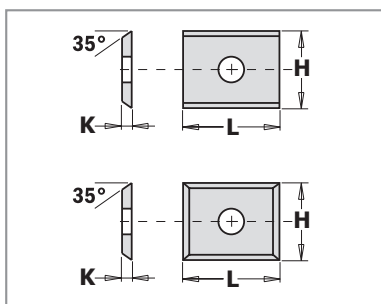

790 Standard Reversible Knives 2 Cutting Edges

L mm	H mm	K mm	A	ORDER NO. K1920	ORDER NO. K2250
7,5	12	1,5	35°	790.075.00	
7,65	12	1,5	35°	790.076.00	
9,6	12	1,5	35°	790.096.00	
15	12	1,5	35°	790.150.00	
19,5	12	1,5	4/35°	790.195.12	
20	12	1,5	35°	790.200.00	790.200.03

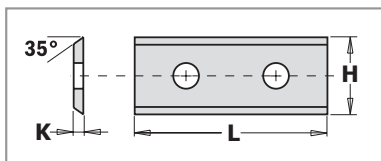

790 Standard Reversible Knives 2 Cutting Edges

L mm	H mm	K mm	A	ORDER NO. K1920	ORDER NO. K2250
24,7	12	1,5	35°	790.250.00	
30	12	1,5	35°	790.300.00	790.300.03
30	12	1,5	45°	790.300.20	
40	12	1,5	35°	790.400.00	790.400.03
50	12	1,5	35°	790.500.00	790.500.03
60	12	1,5	35°	790.600.00	790.600.03

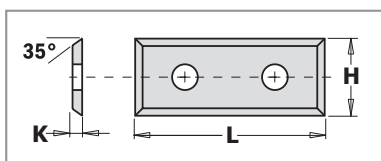

790 Standard Reversible Knives 4 Cutting Edges

L mm	H mm	K mm	A	ORDER NO. K1920	ORDER NO. K2250
29,5	9	1,5	35°	790.295.09	
29,5	12	1,5	35°	790.295.12	
39,5	9	1,5	35°	790.395.09	
39,5	12	1,5	35°	790.395.12	
49,5	9	1,5	35°	790.495.09	
49,5	12	1,5	35°	790.495.12	

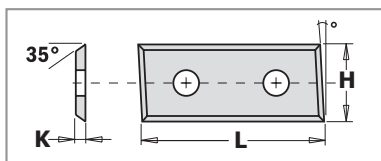

790 Standard Reversible Knives 4 Cutting Edges

L mm	H mm	K mm	A	ORDER NO. K1920	ORDER NO. K2250
28,3	12	1,5	35°	790.283.12	
48,3	12	1,5	35°	790.483.12	

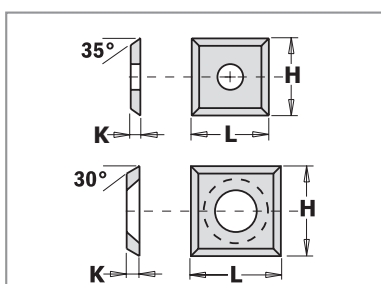

790 Standard Reversible Knives 4 Cutting Edges

L mm	H mm	K mm	A	ORDER NO. K1920	ORDER NO. K2250
12	12	1,5	35°	790.120.00	790.120.03
13,6	13,6	2	30°	790.136.00	
14	14	1,2	30°	790.140.10	
14	14	2	30°	790.140.00	790.140.03
14	14	2	45°	790.140.02	

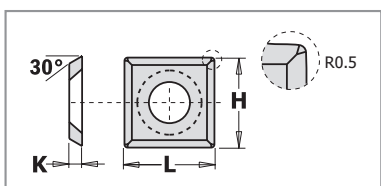

790 Standard Reversible Knives 4 Cutting Edges

L mm	H mm	K mm	A	ORDER NO. K1920	ORDER NO. K2250
12	12	1,5	30°	790.120.20	
14	14	2	30°	790.140.20	

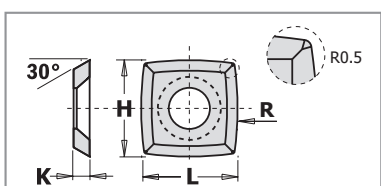

790 Standard Reversible Knives 4 Cutting Edges

L mm	H mm	K mm	A	R mm	ORDER NO. K1920	ORDER NO. K2250
15	15	2,5	30°	115	790.152.12	
15	15	2,5	30°	150	790.152.22	

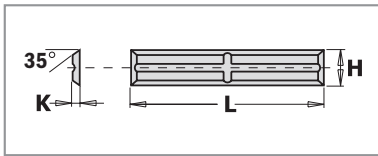

790 Standard Reversible Knives 4 Cutting Edges



L mm	H mm	K mm	A	ORDER NO. K1920
20	4,1	1,1	35°	790.200.01
30	5,5	1,1	35°	790.300.01
50	5,5	1,1	35°	790.500.01

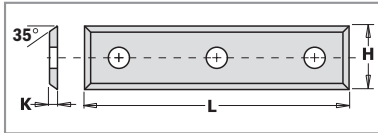

790 Standard Reversible Knives 4 Cutting Edges

L mm	H mm	K mm	A	ORDER NO. K1920
50	9	1,5	35°	790.500.09

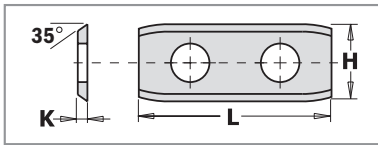

790 Standard Reversible Knives 2 Cutting Edges

L mm	H mm	K mm	A	B	ORDER NO. K1920
20	12	1,5	35°	1 bore	790.201.00
30	12	1,5	35°	2 bore	790.301.00
50	12	1,5	35°	2 bore	790.501.00

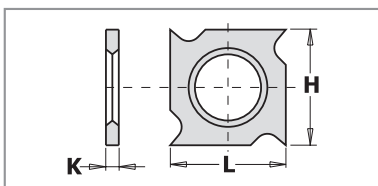

790 Standard Reversible Knives 4 Cutting Edges

L mm	H mm	K mm	ORDER NO. K1920
18	18	1,95	790.181.00
18	18	2,45	790.182.00

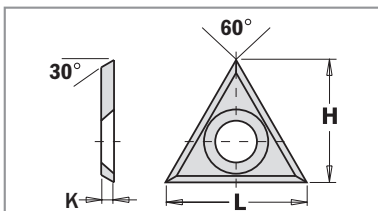

790 Standard Reversible Knives 30°

L mm	H mm	K mm	A	ORDER NO. K1920
22	19	2	30°	790.220.02

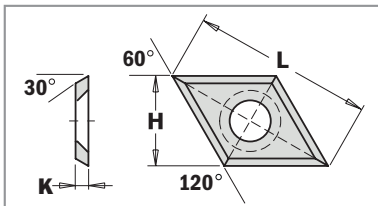

790 Standard Reversible Knives 2 Cutting Edges 30°

L mm	H mm	K mm	A	ORDER NO. K1920
28	14	2	30°	790.280.00

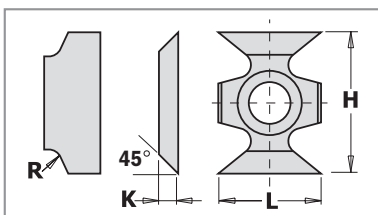

790 Edge Rounding/Chamfering Reversible Knives

L mm	H mm	K mm	R mm	A	ORDER NO. K1920
16	22	5	1,5		790.161.00
16	22	5	2		790.162.00
16	22	5	3		790.163.00
16	22	5		45°	790.160.00

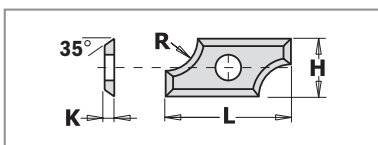

790 Profiled Rounding Reversible Knives 4 Cutting Edges

L mm	H mm	K mm	R mm	A	ORDER NO. K1920
19,5	9	1,5	2	35°	790.020.00
19,5	9	1,5	3	35°	790.030.00
19,5	9	1,5	5	35°	790.050.00
24	12	1,5	6,4	35°	790.064.00
24	12	1,5	8	35°	790.080.00

MATERIAL	K1920	K2250
Softwood	★★★★★	
Hardwood	★★★★★	
Chipboard	★★★★★	★★★★★
MDF	★★★★★	★★★★★
HDF	★★★★★	★★★★★
Plastics	★★★	★★★★★
Solid Surface		★★★★★

★★★★★ Excellent
 ★★★★ Very Good
 ★★★ Good

TECHNICAL DETAILS:

K1920 Hardness (HV10): 1.920 - Transverse rupture strength (N/mm²): 2.600
 New chrome grade for universal cutting applications. Excellent resistance to corrosion, oxidation and mechanical wear. High efficiency, 20% longer lifetime compared to standard grade.

K2250 Hardness (HV10): 2.250 - Transverse rupture strength (N/mm²): 2.400
 New nano-grain grade for maximum wear resistance. Higher efficiency due to improved tool lifetime. Improved toughness.

All knives are supplied in a 10 pc. case.
 Minimum 10 piece or multiple of 10 piece order.



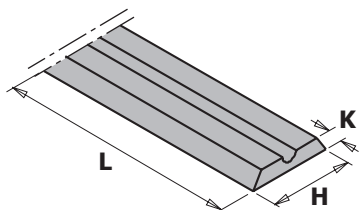

10-PCS. CASE (minimum order or multiple)

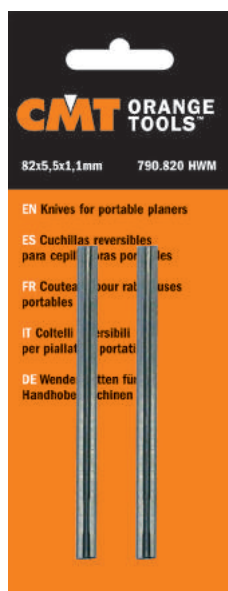

2-PCS. BLISTER CASE

(790.755/790.780/790.806/790.805/790.820)

790

L mm	H mm	K mm	MACHINE	MODEL MACHINE	ORDER NO. 2-pcs. blister case	ORDER NO. 10-pcs. blister case
56,0	5,5	1,1	Adler			790.560.00
60,0	5,5	1,1	Wegoma			790.600.01
75,5	5,5	1,1	Aeg	HTH75	790.755	790.755.00
			Black & Decker	DN75, 750SR, 600K		
			Bosch	0590, P400, 1590,1591		
			Festool	REP75		
			Haffner	FH222		
			Holz-Her	2223, 2286, 2320		
			Kress	Jet-Star 6701, 6702		
			Mafell	HU75		
			Metabo	6375		
			Scheer	MH75/3, MH80		
			Skil	98H		
78,0	5,5	1,1	Virutex		790.780	790.780.00
80,5	5,9	1,2	Elu	MFF40, MFF80, MFF81, MFF81EK, PF161	790.806	790.805.00
80,5	5,5	1,1	Elu Aeg, Bosch Haffner	MFF80	790.805	790.805.01
82,0	5,5	1,1	Aeg	EH82, EH825, EH822, EH450, EH700, EH82-1, H500, H750, EH700R	790.820	790.820.00
			Black & Decker	DN76		
			Bosch	PHO 100/150, PHO 200/300 4387, PHO 2-82/3-82, Gustav, H00882		
			Casals	CE82		
			DeWalt	DW678, DW678EK, DW680		
			Elu	HH15, HH40, HH40K, HH40EK		
			Fein	HS2151		
			Felisatti	TP282		
			Haffner	FH224		
			Hitachi	F20, F20A, FP20A, P20V, P20SA		
			Holz-Her	2321, 2322		
			Legna	R82, G82		
			Mafell	EHU82, MHU82		
			Makita	1001, 1100, 1125B, 1900B, 1901, 1923B, 1923H, 1923HO		
			Metabo	4382, 8382, 0882, 0883, E0983		
			Peerles	HHB82B		
			Peugeot	RA400, 82RAC, RA82CS, BR82 BRA1-82, BRA3-82, RA1082CA		
			Ryobi	L1323-A		
			Skil	H92, H94, H95, H96, H97 1506, 1510		
			Stayer	980B		
92,0	5,5	1,2	Aeg	450		790.920.00
			Hitachi	F30A, FU30		
			Ryobi	L120N, L150N, L1205N, L1323		
102,0	5,5	1,1	Aeg	HB750, EH102, HBE800		790.992.00

L mm	H mm	K mm	MACHINE	MODEL MACHINE	ORDER NO. 2-pcs. HSS	ORDER NO. 2-pcs. HW
82,0	29	3	Bosch	GH020-82	790.821.50	790.821.10
			B&D	DN710, DB711		
			Makita	1900B, 1923B, 1100, 1901 1125		
			Ryobi	L-1323A, L-282		



TECHNICAL DETAILS:

- Order no. ISO: K40
- Hardness (HV10): 1.400
- Transverse rupture strength (N/mm²): 2.600

APPLICATION:

- Softwood Good
- Hardwood Suitable
- Plywood Suitable



2-PCS. BLISTER CASE