

Section  
**INDEX**

**INDEX**  
by article

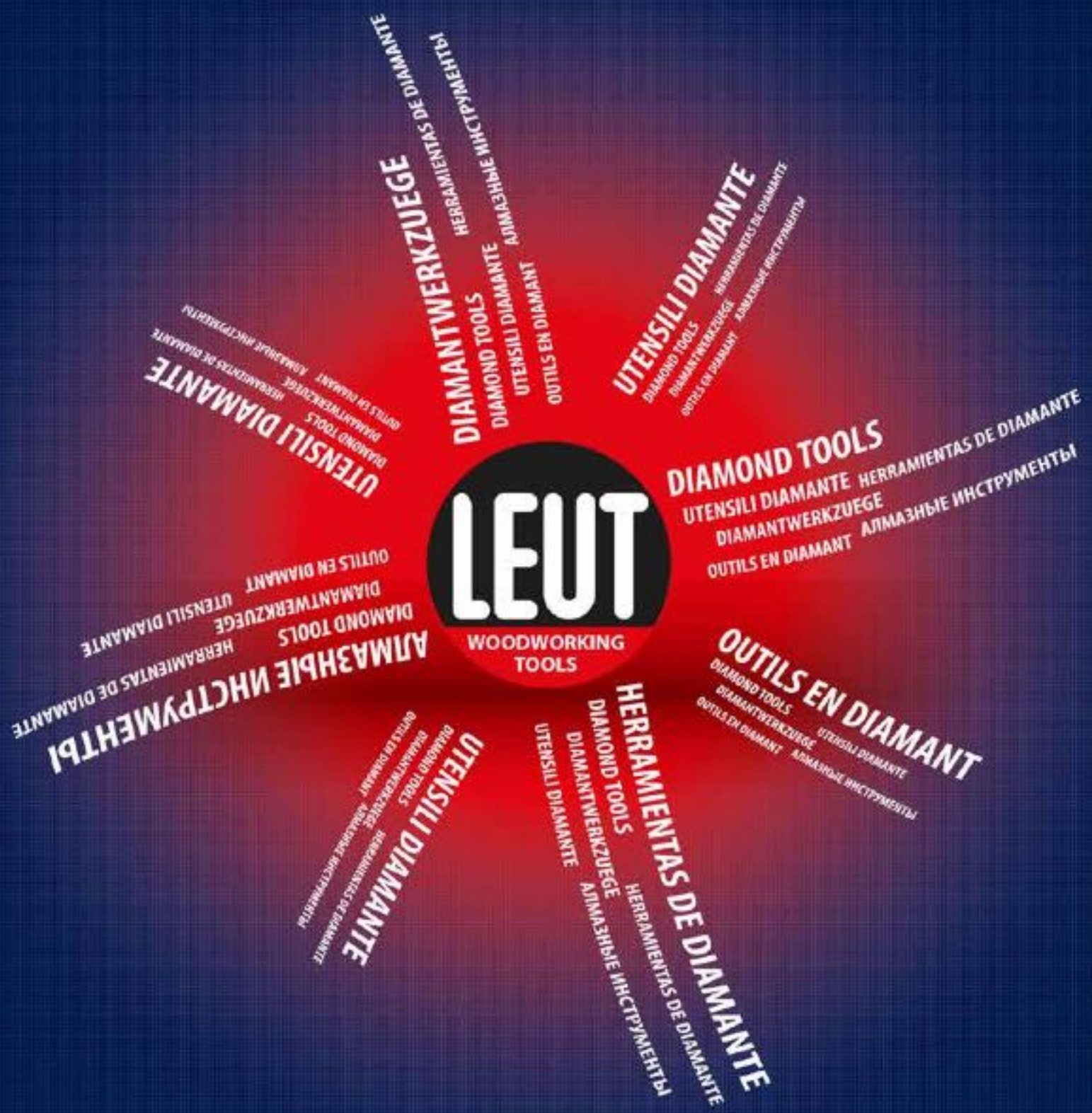

# DIAMOND TOOLS





**UTENSILI DIAMANTE**

**DIAMOND TOOLS**

**DIAMANTWERKZUEGE**

**HERRAMIENTAS DE DIAMANTE**

**OUTILS EN DIAMANT**

**АЛМАЗНЫЕ ИНСТРУМЕНТЫ**



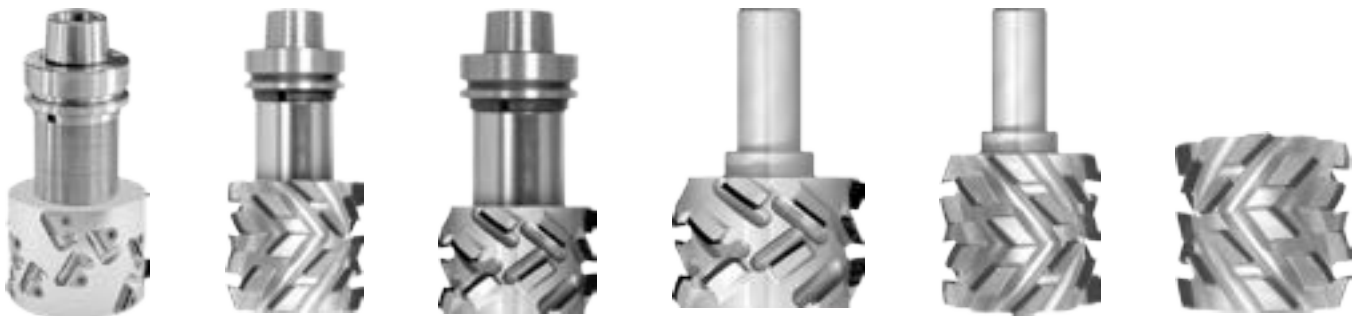
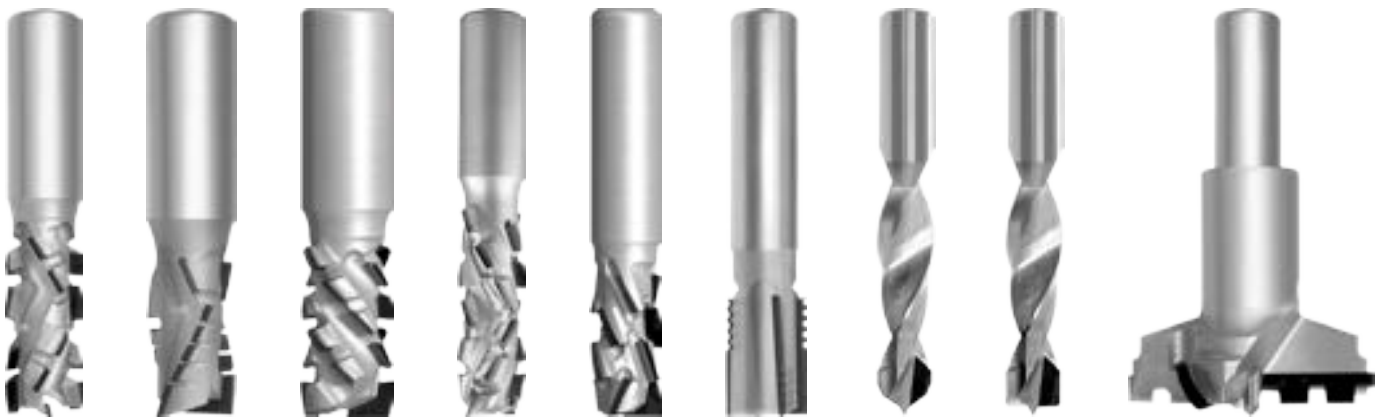

## LAME IN DIAMANTE

DIAMOND SAW BLADES  
DIAMANTKREISSÄGEBLATT  
HOJAS CIRCULARES EN DIAMANTE  
LAMES EN DIAMANT  
АЛМАЗНЫЕ ПИЛЫ



pag.  
9

## FRESE IN DIAMANTE PER FORARE E CONTORNARE PUNTE IN DIAMANTE PER FORARE

DIAMOND TOOLS FOR BORING AND CONTOURING  
DIAMOND ROUTERS FOR BORING

DIAMANTFRÄSER LÖCHER BOHREN UND FÜGEN  
DIAMANTBOHRER LÖCHER BOHREN

FRESAS EN DIAMANTE PARA TALADRAR Y CONTORNEA  
Û BROCA EN DIAMANTE PARA TALADRAR

FRAISES EN DIAMANT POUR PERCER ET CONTOURNER  
MECHES EN DIAMANT POUR PERCER

ФРЕЗЫ ДЛЯ СВЕРЛЕНИЙ И КОНТУРНОЙ ОБРАБОТК  
АЛМАЗНЫЕ ФРЕЗЫ ДЛЯ СВЕРЛЕНИЙ И



pag.  
25

## FRESE IN DIAMANTE PROFILATE

DIAMOND TOOLS PROFILED  
PROFILDIAMANTFRÄSER  
FRESAS EN DIAMANTE PERFILADAS  
FRAISE EN DIAMANT PROFILEES  
ПРОФИЛИРОВАННЫЕ АЛМАЗНЫЕ ФРЕЗЫ



pag.  
63

## FRESE IN DIAMANTE ANTISCHEGGIA PER RETTIFICA

DIAMOND TOOLS ANTI-SPLIT FOR GRINDING  
SPLITTERSCHUTZ DIAMANTFRÄSER ZUM SCHLEIFEN  
FRESAS EN DIAMANTE INASTILLABLE DE AJUSTE  
FRAISES EN DIAMANT ANTI ECHARDE POUR AJUSTEMENT  
АЛМАЗНЫЕ ФРЕЗЫ АНТИ-СКОЛ ДЛЯ ШЛИФОВАНИЯ



pag.  
85

## FRESE IN DIAMANTE PER BORDATRICE

EDGEBANDING DIAMOND TOOLS  
DIAMANTFRÄSER FÜR KANTENBANDER MASCHINE  
FRESAS EN DIAMANTE PARA BANDA DE BORDE  
FRAISES EN DIAMANT POUR PLAQUEUSE  
АЛМАЗНЫЕ ФРЕЗЫ ДЛЯ КРОМКООБЛИЦОВОЧНОГО СТАНКА



pag.  
95

Art.			pag.
<b>Art. D7A</b>	confezione di 5 punte in diamante Z2 con corpo in acciaio DP H 4,5 mm	<i>Kit comprising DP diamond tools, H4.5mm</i>	<b>68</b>
<b>Art. D7B</b>	confezione di 5 punte in diamante Z2 con corpo in acciaio DP H 4,5 mm	<i>Kit comprising DP diamond tools, H4.5mm</i>	<b>70</b>
<b>Art. D7C</b>	confezione di 5 punte in diamante Z2 con corpo in acciaio DP H4,5 mm	<i>Kit comprising DP diamond tools, H4.5mm</i>	<b>72</b>
<b>Art. D7D</b>	confezione di 4 punte in diamante Z2 con corpo in acciaio DP H 4,5 mm	<i>Kit comprising DP diamond tools, H4.5mm</i>	<b>74</b>
<b>Art. D11A</b>	confezione di 5 punte in diamante Z2 con corpo in acciaio DP H 4,5 mm	<i>Kit comprising DP diamond tools, H4.5mm</i>	<b>76</b>
<b>Art. D11B</b>	confezione di 5 punte in diamante Z2 con corpo in acciaio DP H 4,5 mm	<i>Kit comprising DP diamond tools, H4.5mm</i>	<b>78</b>
<b>Art. D11C</b>	confezione di 5 punte in diamante Z2 con corpo in acciaio DP H 4,5 mm	<i>Kit comprising DP diamond tools, H4.5mm</i>	<b>80</b>
<b>Art. D11D</b>	confezione di 4 punte in diamante Z2 con corpo in acciaio DP H 4,5 mm	<i>Kit comprising DP diamond tools, H4.5mm</i>	<b>82</b>
<b>Art. D101</b>	lama in diamante DP H 4 mm	<i>DP diamond blade, H 4 mm</i>	<b>11</b>
<b>Art. D102</b>	lama in diamante DP H 6 mm	<i>DP diamond blade, H 6 mm</i>	<b>11</b>
<b>Art. D103</b>	lama in diamante per sezionatrici DP H 4 mm	<i>Low noise DP diamond blade, H4mm, for panel sizing saws</i>	<b>12</b>
<b>Art. D104</b>	lama in diamante per sezionatrici DP H 6 mm	<i>Low noise DP diamond blade, H6 mm, for panel sizing saws</i>	<b>14</b>
<b>Art. D105</b>	Lama incisore conico in diamante DP H4mm	<i>DP diamond conical scoring blade, H4mm</i>	<b>16</b>
<b>Art. D106</b>	Lama incisore conico in diamante DP H6 mm	<i>DP diamond conical scoring blade, H6mm</i>	<b>18</b>
<b>Art. D107</b>	Lama incisore in diamante regolabile DP H4 mm	<i>Adjustable DP diamond scoring blade, H4mm</i>	<b>20</b>
<b>Art. D108</b>	Lama incisore in diamante regolabile DP H6 mm	<i>Adjustable DP diamond scoring blade, H6mm</i>	<b>21</b>
<b>Art. D109</b>	fresa in diamante per giunzioni lamello Clamex P-System corpo in acciaio DP H 3,5 mm	<i>DP diamond cutter for Lamello Clamex P-system connectors, steel body, H 3.5 mm</i>	<b>59</b>
<b>Art. D110</b>	lama in diamante per materiali duri e abrasivi DP H 4 mm	<i>DP diamond blade for hard and abrasive materials, H 4 mm</i>	<b>22</b>
<b>Art. D111</b>	lama in diamante corpo in acciaio speciale, affilabile 2 volte	<i>diamond blade, special steel body, sharpenable 2 times</i>	<b>22</b>
<b>Art. D201</b>	fresa in diamante con tagliente diritto Z1 con corpo HW DP H 3,5 mm	<i>DP diamond router bit with straight cut Z1, HW body, H 3.5 mm</i>	<b>29</b>
<b>Art. D203</b>	fresa in diamante con tagliente negativo Z1 con corpo HW DP H 3,5 mm	<i>DP diamond router bit with negative cut Z1, HW body, H 3.5 mm</i>	<b>29</b>
<b>Art. D204</b>	fresa in diamante con tagliente diritto Z2 con corpo HW DP H 3,5 mm	<i>DP diamond router bit with straight cut Z2, HW body, H 3.5 mm</i>	<b>30</b>
<b>Art. D206</b>	fresa in diamante con tagliente negativo Z2 con corpo HW DP H 3,5 mm	<i>DP diamond router bit with negative cut Z2, HW body, H 3.5 mm</i>	<b>30</b>
<b>Art. D212</b>	fresa in diamante elicoidale Z1+1 con corpo in acciaio DP H 2,5 mm	<i>DP diamond helical router bit Z1+1, steel body, H 2.5 mm</i>	<b>33</b>
<b>Art. D213</b>	fresa in diamante elicoidale Z1+1 con corpo in acciaio DP H 4,5 mm	<i>DP diamond helical router bit Z1+1, steel body, H 4.5 mm</i>	<b>32</b>
<b>Art. D214</b>	fresa in diamante elicoidale con cuscinetto Z1+1 con corpo in acciaio DP H 2,5 mm	<i>DP diamond helical router bit Z1+1 with copy bearing, steel body, H 2.5 mm</i>	<b>36</b>
<b>Art. D215</b>	fresa in diamante elicoidale Z2+2 con corpo in acciaio DP H 2,5 mm	<i>DP diamond helical router bit Z2+2, steel body, H 2.5 mm</i>	<b>34</b>
<b>Art. D216</b>	fresa in diamante elicoidale Z2+2 con corpo in acciaio DP H 4,5 mm	<i>DP diamond helical router bit Z2+2, steel body, H 4.5 mm</i>	<b>35</b>
<b>Art. D220</b>	fresa in diamante elicoidale Z2+2 con corpo in acciaio DP H 2,5 mm	<i>DP diamond helical router bit Z2+2, steel body, H 2.5 mm</i>	<b>37</b>
<b>Art. D221</b>	fresa in diamante elicoidale Z2+2 con corpo in acciaio DP H 2,5 mm	<i>DP diamond helical router bit Z2+2, steel body, H 2.5 mm</i>	<b>38</b>



Art.			pag.
<b>Art. D224</b>	fresa in diamante elicoidale Z3+3 con corpo in acciaio DP H 4,5 mm	<i>DP diamond helical router bit Z3+3, steel body, H 4.5 mm</i>	<b>39</b>
<b>Art. D225</b>	fresa in diamante elicoidale Z3+3 con corpo in acciaio DP H 4,5 mm	<i>DP diamond helical router bit Z3+3, steel body, H 4.5 mm</i>	<b>40</b>
<b>Art. D228</b>	fresa in diamante elicoidale Z2+2 con corpo in acciaio DP H 4,5 mm	<i>DP diamond helical router bit Z2+2, steel body, H 4.5 mm</i>	<b>41</b>
<b>Art. D229</b>	fresa in diamante elicoidale Z2+2 con corpo in acciaio DP H 4,5 mm	<i>DP diamond helical router bit Z2+2, steel body, H 4.5 mm</i>	<b>42</b>
<b>Art. D230</b>	fresa in diamante elicoidale Z3+3 con corpo in acciaio DP H 4,5 mm	<i>DP diamond helical router bit Z3+3, steel body, H 4.5 mm</i>	<b>43</b>
<b>Art. D232</b>	fresa in diamante elicoidale simmetrica Z2+2 con corpo in acciaio DP H 4,5 mm	<i>DP diamond helical router bit Z2+2, SYMMETRICAL, steel body, H 4.5 mm</i>	<b>44</b>
<b>Art. D233</b>	fresa in diamante elicoidale Z2+2 con corpo in acciaio DP H 4,5 mm	<i>DP diamond helical router bit Z2+2, steel body, H 4.5 mm</i>	<b>45</b>
<b>Art. D234</b>	fresa in diamante elicoidale Z2+2 con corpo in acciaio DP H 4,5 mm	<i>DP diamond helical router bit Z2+2, steel body, H 4.5 mm</i>	<b>46</b>
<b>Art. D236</b>	fresa in diamante elicoidale Z2+2 con corpo in acciaio DP H 4,5 mm	<i>DP diamond helical router bit Z2+2, steel body, H 4.5 mm</i>	<b>47</b>
<b>Art. D239</b>	fresa in diamante con tagliente positivo negativo Z4 rompitruciolo con corpo in HDM metallo pesante DP H 3,5 mm	<i>DP diamond router bit with positive+negative cut Z4, chip-breaker, high density metal body, H 3.5 mm</i>	<b>32</b>
<b>Art. D240</b>	fresa in diamante elicoidale Z2+2 con corpo in HDM metallo pesante DP H 3,5 mm	<i>DP diamond helical router bit Z2+2, high density metal body, H 3.5 mm</i>	<b>48</b>
<b>Art. D241</b>	fresa in diamante elicoidale Z3+3 con corpo in HDM metallo pesante DP H 3,5 mm	<i>DP diamond helical router bit Z3+3, high density metal body, H 3.5 mm</i>	<b>50</b>
<b>Art. D242</b>	fresa in diamante elicoidale Z3+3 con corpo in HDM metallo pesante DP H 3,5 mm	<i>DP diamond helical router bit Z3+3, HDM heavy metal body, H 3.5 mm</i>	<b>52</b>
<b>Art. D243</b>	fresa in diamante elicoidale Z3+3 con corpo in HDM metallo pesante DP H 3,5 mm	<i>DP diamond helical router bit Z3+3, high density metal body, H 3.5 mm</i>	<b>51</b>
<b>Art. D245</b>	fresa in diamante elicoidale Z1+1 con corpo HW DP H 2,5 mm	<i>DP diamond helical router bit Z1+1, HW body, H 2.5 mm</i>	<b>31</b>
<b>Art. D246</b>	fresa in diamante con tagliente positivo negativo Z2 con corpo HW DP H 3,5 mm	<i>DP diamond router bit with positive+negative cut Z2, HW body, H 3.5 mm</i>	<b>31</b>
<b>Art. D248</b>	fresa in diamante elicoidale Z2+2 con corpo in acciaio DP H 4,5 mm	<i>DP diamond helical router bit Z2+2, steel body, H 4.5 mm</i>	<b>53</b>
<b>Art. D249</b>	fresa in diamante elicoidale Z3+3 con corpo in acciaio DP H 4,5 mm	<i>DP diamond helical router bit Z3+3, steel body, H 4.5 mm</i>	<b>54</b>
<b>Art. D250</b>	fresa in diamante elicoidale da rettifica Z4+4 con corpo in acciaio DP H 4,5 mm	<i>DP diamond helical router bit Z4+4 for finishing, steel body H 4.5 mm</i>	<b>87</b>
<b>Art. D251</b>	fresa in diamante da rettifica su HSK63F Z4+4 DP H 4,5 mm	<i>DP diamond router bit Z4+4 for finishing, HSK63F shank, H 4.5 mm</i>	<b>89</b>
<b>Art. D252</b>	fresa in diamante Z2+2 per serrature porte con corpo in HDM metallo pesante DP H 3,5 mm	<i>DP diamond cutter Z2+2 for door locks with high density metal body, H 3.5 mm</i>	<b>57</b>
<b>Art. D253</b>	fresa in diamante da rettifica su HSK63F Z3+3 DP H 4,5 mm	<i>DP diamond router bit Z3+3 for finishing, HSK63F shank, H 4.5 mm</i>	<b>90</b>
<b>Art. D255</b>	fresa in diamante elicoidale da rettifica Z3+3 con corpo in acciaio DP H 4,5 mm	<i>DP diamond helical router bit Z3+3 for finishing, steel body, H 4.5 mm</i>	<b>92</b>
<b>Art. D256</b>	fresa in diamante per spianare Z3 / Z4 / Z6 con corpo in acciaio DP H 4,5 mm	<i>diamond router bit for planing Z3 / Z4 / Z6, steel body, H 4.5 mm</i>	<b>56</b>
<b>Art. D259</b>	fresa in diamante elicoidale Z2+2 con corpo in HDM metallo pesante DP H 3,5 mm	<i>DP diamond helical router bit Z2+2, high density metal body, H 3.5 mm</i>	<b>49</b>
<b>Art. D260</b>	fresa in diamante elicoidale da rettifica Z3+3 con corpo in acciaio DP H 4,5 mm	<i>DP diamond radius router bit Z3+3 for nesting, steel body H 4.5 mm</i>	<b>88</b>
<b>Art. D261</b>	Fresa in diamante per nesting con raggio DP H3.5mm	<i>DP diamond radius cutter for nesting, H3.5mm</i>	<b>65</b>
<b>Art. D265</b>	fresa in diamante elicoidale da rettifica Z3+3 con corpo in acciaio DP H 4,5 mm	<i>DP diamond helical router bit Z3+3 for contouring, steel body, H 4.5 mm</i>	<b>93</b>
<b>Art. D275</b>	Fresa in diamante per folding a 45° DP H4.5mm	<i>DP diamond cutter for 45° folding, H4.5mm</i>	<b>66</b>

Art.			pag.
<b>Art. D276</b>	Fresa in diamante per folding DP H4mm	<i>DP diamond cutter for folding, H4mm</i>	<b>66</b>
<b>Art. D307</b>	Testa in diamante antisceggia per bordatrice con coltelli a gettare DP H3mm, assialità 45°	<i>DP diamond anti-splinter head with reversible knives for edgebander, H3mm, 45° axial angle</i>	<b>101</b>
<b>Art. D308</b>	fresa in diamante T-SLOT per profili in alluminio Z2+2 corpo in acciaio DP H 4,5 mm	<i>DP diamond T-SLOT router bit Z2+2 for aluminium profiles, steel body H 4.5 mm</i>	<b>67</b>
<b>Art. D309</b>	fresa in diamante per giunzioni lamello Clamex P-System Z1 corpo in HDM metallo pesante DP H 3 mm	<i>DP diamond cutter Z1 for Lamello Clamex P-system connectors, high density metal body, H 3</i>	<b>58</b>
<b>Art. D310</b>	Testa antisceggia in diamante con coltelli a gettare DP H3mm, su HSK63F, assialità 45°	<i>DP diamond anti-splinter head with reversible knives, H3mm, on HSK63F, 45° axial angle</i>	<b>91</b>
<b>Art. D351</b>	fresa HW integrale per giunzioni lamello Clamex P-System Z2	<i>full HW router bit Z2 for Lamello Clamex P-system connectors</i>	<b>58</b>
<b>Art. D401</b>	Fresa in diamante antisceggia per bordatrice DP H2.5mm angoli assiali 20°/30°	<i>Anti-splinter DP diamond cutter for edgebander, H2.5mm, 20°/30° axial angles</i>	<b>103</b>
<b>Art. D402</b>	Fresa in diamante antisceggia per bordatrice DP H2.5mm, angoli assiali 20°/30°	<i>Anti-splinter DP diamond cutter for edgebander, H2.5mm, 20°/30° axial angles</i>	<b>111</b>
<b>Art. D403</b>	Fresa in diamante antisceggia per bordatrice DP H4.5mm, angoli assiali 20°/30°	<i>Anti-splinter DP diamond cutter for edgebander, H2.5mm, 20°/30° axial angles</i>	<b>107</b>
<b>Art. D404</b>	Fresa in diamante antisceggia per bordatrice DP H4.5mm angoli assiali 20°/30°	<i>Anti-splinter DP diamond cutter for edgebander, H4.5mm, 20°/30° axial angles</i>	<b>115</b>
<b>Art. D413</b>	Fresa in diamante antisceggia per bordatrice DP H4.5mm con angoli assiali 45°	<i>Anti-splinter DP diamond cutter for edgebander, H4.5mm, with 45° axial angles</i>	<b>119</b>
<b>Art. D419</b>	Fresa in diamante antisceggia per bordatrice DP H4.5mm con angoli assiali 54,9°	<i>Anti-splinter DP diamond cutter for edgebander, H4.5mm, with 54.9° axial angles</i>	<b>122</b>
<b>Art. D429</b>	Frese in diamante per bordatrice DP H2.5mm / 4.5mm	<i>DP diamond cutters for edgebander, H2.5mm/4.5mm</i>	<b>97</b>
<b>Art. D435</b>	Fresa per incastri regolabile in diamante DP H4.5mm	<i>Adjustable DP diamond cutter for grooves, H4.5mm</i>	<b>24</b>
<b>Art. D437</b>	Frese in diamante per bordatrice DP H2.5mm / 4.5mm	<i>DP diamond cutters for edgebander, H2.5mm/4.5mm</i>	<b>97</b>
<b>Art. D490</b>	Frese per incastri in diamante DP H4.5mm	<i>DP diamond cutters for grooves, H4.5mm</i>	<b>23</b>
<b>Art. D501</b>	Frese in diamante per bordatrici inclinate DP H3mm	<i>Inclined DP diamond cutters for edgebanders, H3mm</i>	<b>98</b>
<b>Art. D502</b>	Frese in diamante per bordatrici inclinate DP H3mm	<i>Inclined DP diamond cutters for edgebanders, H3mm</i>	<b>98</b>
<b>Art. D503</b>	Frese in diamante per bordatrici raggiate DP H3mm	<i>DP diamond radius cutters for edgebanders, H3mm</i>	<b>100</b>
<b>Art. D504</b>	Frese in diamante per bordatrici raggiate DP H3mm	<i>DP diamond radius cutters for edgebanders, H3mm</i>	<b>99</b>
<b>Art. D505</b>	Frese in diamante per bordatrici raggiate DP H3mm	<i>DP diamond radius cutters for edgebanders, H3mm</i>	<b>100</b>
<b>Art. D701</b>	punta in diamante foratrice per fori passanti Z1 corpo in acciaio	<i>diamond drill bit Z1 for through holes, steel body</i>	<b>60</b>
<b>Art. D702</b>	punta in diamante foratrice per fori passanti Z2 corpo in HW	<i>diamond drill bit Z2 for through holes, HW body</i>	<b>60</b>
<b>Art. D703</b>	punta in diamante foratrice per fori ciechi Z2 corpo in HW	<i>diamond drill bit Z2 for blind holes, HW body</i>	<b>61</b>
<b>Art. D704</b>	punta in diamante foratrice per fori passanti Z2+2 corpo in acciaio	<i>diamond drill bit Z2+2 for through holes, steel body</i>	<b>62</b>
<b>Art. D705</b>	punta in diamante foratrice per fori ciechi Z2+2 con rompitruciolo corpo in acciaio	<i>diamond drill bit Z2+2 for blind holes, with chip-breaker, steel body</i>	<b>61</b>
<b>Art. D820</b>	ghiera turbo con turbina per estrazione trucioli	<i>turbo ring for chip removal</i>	<b>55</b>
<b>Art. D833</b>	albero portalama con attacco cilindrico	<i>blade holder with cylindrical shank</i>	<b>59</b>
<b>Art. D836</b>	chiave a settore din 1810 per ghiera turbo 820	<i>DIN 1810 c-spanner for turbo ring 820</i>	<b>55</b>







## **LAME IN DIAMANTE**

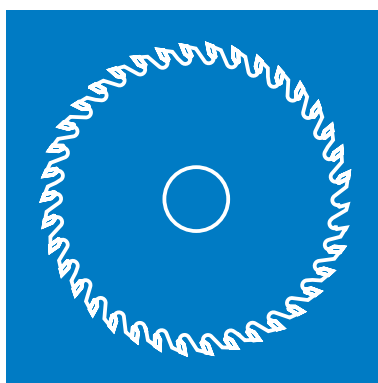

**DIAMOND SAW BLADES**

**DIAMANTKREISSÄGEBLATT**

**HOJAS CIRCULARES EN DIAMANTE**

**LAMES EN DIAMANT**

**АЛМАЗНЫЕ ПИЛЫ**

# lame in diamante

diamond saw blades

Diamantkreissägeblatt

Hojas circulares en diamante

lames en diamant

алмазные пилы

Section  
INDEX

INDEX  
by article

**Art. D101**

pag.  
11



**Art. D107**

pag.  
20



**Art. D102**

pag.  
11



**Art. D108**

pag.  
21



**Art. D103**

pag.  
12



**Art. D110**

pag.  
22

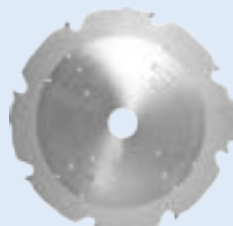

**Art. D104**

pag.  
14



**Art. D111**

pag.  
22



**Art. D105**

pag.  
16



**Art. D490**

pag.  
23



**Art. D106**

pag.  
18



**Art. D435**

pag.  
24



# Art. D101

## lama in diamante DP H 4 mm

DP diamond blade, H 4 mm

Diamantblatt DP H 4 mm

hoja de diamante con plaquita en DP de H 4 mm

Lame en diamant DP H 4

Алмазная пила DP H 4 mm

Section INDEX

INDEX by article



Cod.	ø D mm	B mm	b mm	ø d mm	Z tot	FT / PH
D101 10	250	3,2	2,2	30	54	2(7/42)+2(9/46,4)+2(10/60)
D101 11	250	3,2	2,2	30	60	2(7/42)+2(9/46,4)+2(10/60)
D101 12	250	3,2	2,2	30	80	2(7/42)+2(9/46,4)+2(10/60)
D101 13	300	3,2	2,2	30	48	2(7/42)+2(9/46,4)+2(10/60)
D101 14	300	3,2	2,2	30	60	2(7/42)+2(9/46,4)+2(10/60)
D101 15	300	3,2	2,2	30	72	2(7/42)+2(9/46,4)+2(10/60)
D101 16	300	3,2	2,2	30	96	2(7/42)+2(9/46,4)+2(10/60)
D101 17	350	3,5	2,5	30	84	2(7/42)+2(9/46,4)+2(10/60)
D101 18	350	3,5	2,5	30	108	2(7/42)+2(9/46,4)+2(10/60)

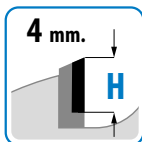
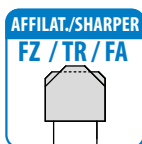

PRICE LIST

Lama in diamante per seghe circolari a banco e sezionatrici orizzontali. Ideali per la sezionatura di pannelli bilaminati con l'ausilio dell'incisore.

DP saw blade tips to be used on sliding table saw saws and horizontal panel saws. Suitable for cutting bilaminated panels using scoring blade.

Diamantblatt für Bautischkreis- und horizontale Plattenaufteilsägen. Ideal zum Aufteilen von beidseitig laminierten Platten mit Vorritzer.

Hoja de diamante para sierras circulares de banco y seccionadoras horizontales. Es ideal para seccionar paneles laminados en las dos caras con la ayuda de la sierra grabadora.

Lame en diamant pour scies circulaires et scies à panneaux horizontales. Idéales pour la coupe de panneaux bilaminés avec l'utilisation de l'inciseur.

Алмазная пила для циркулярных горизонтальных и вертикальных станков. С помощью подрезной пилы идеальная для распила биламинат панелей.

# Art. D102

## lama in diamante DP H 6 mm

DP diamond blade, H 6 mm

Diamantblatt DP H 6 mm

hoja de diamante con plaquita en DP de H 6 mm

Lame en diamant DP H 6

Алмазная пила DP H 6 mm



Cod.	ø D mm	B mm	b mm	ø d mm	Z tot	FT / PH
D102 10	250	3,2	2,2	30	54	2(7/42)+2(9/46,4)+2(10/60)
D102 11	250	3,2	2,2	30	60	2(7/42)+2(9/46,4)+2(10/60)
D102 12	250	3,2	2,2	30	80	2(7/42)+2(9/46,4)+2(10/60)
D102 13	300	3,2	2,2	30	48	2(7/42)+2(9/46,4)+2(10/60)
D102 14	300	3,2	2,2	30	60	2(7/42)+2(9/46,4)+2(10/60)
D102 15	300	3,2	2,2	30	72	2(7/42)+2(9/46,4)+2(10/60)
D102 16	300	3,2	2,2	30	96	2(7/42)+2(9/46,4)+2(10/60)
D102 17	350	3,5	2,5	30	84	2(7/42)+2(9/46,4)+2(10/60)
D102 18	350	3,5	2,5	30	108	2(7/42)+2(9/46,4)+2(10/60)

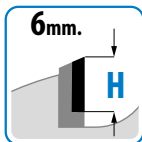
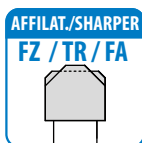

PRICE LIST

Lama in diamante per seghe circolari a banco e sezionatrici orizzontali. Ideali per la sezionatura di pannelli bilaminati con l'ausilio dell'incisore.

DP saw blade tips to be used on sliding table saw saws and horizontal panel saws. Suitable for cutting bilaminated panels using scoring blade.

Diamantblatt für Bautischkreis- und horizontale Plattenaufteilsägen. Ideal zum Aufteilen von beidseitig laminierten Platten mit Vorritzer.

Hoja de diamante para sierras circulares de banco y seccionadoras horizontales. Es ideal para seccionar paneles laminados en las dos caras con la ayuda de la sierra grabadora.

Lame en diamant pour scies circulaires et scies à panneaux horizontales. Idéales pour la coupe de panneaux bilaminés avec l'utilisation de l'inciseur.

Алмазная пила для циркулярных горизонтальных и вертикальных станков. С помощью подрезной пилы идеальная для распила биламинат панелей.

Low noise DP diamond blade, H4mm, for panel sizing saws

Diamantblatt (geräuscharm) für Plattenaufteil-sägen PKD H 4 mm

Hoja silenciosa de diamante con plaquita en DP de H 4 mm para seccionadora

Lame en diamant silencieuse pour scies à panneaux, DP H4 mm

Алмазная шумопонижающая пила для станка DP H4mm

Section INDEX

INDEX by article

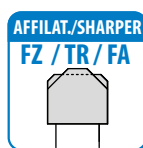
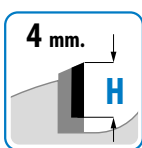

Lama in diamante DP H4mm con corpo in acciaio speciale per ridurre la rumorosità (silenziosa) per macchine squadratrici, sezionatrici, per taglio di pannelli grezzi e rivestiti con l'ausilio dell'incisore

Diamantblatt PKD H 4 mm mit Körper aus Sonderstahl zur Geräuschreduzierung (geräuscharm) für Formatkreissäge(maschinen), Plattenaufteil-sägen, zum Aufteilen von unbeschichteten und beschichteten Platten mit Vorritzer

Lame en diamant, DP H4 mm avec corps en acier spécial pour réduire le bruit (silencieuse) pour scies à format, scies à panneaux, pour la coupe de panneaux bruts et revêtus, grâce à l'inciseur.

DP diamond blade, H4mm, with special steel body designed to reduce noise levels (low noise) for squaring and panel sizing saws, also for cutting raw and laminated panels in conjunction with scoring blade

Hoja de diamante con plaquita en DP de H 4 mm y cuerpo de acero especial para reducir el ruido (silenciosa). Es ideal para el escuadrado, seccionado y corte de paneles brutos y revestidos con la ayuda de la sierra grabadora.

Алмазная шумопонижающая пила DP H4mm с корпусом из специальной стали для 4-х сторонних и форматно-раскроечных станков, для раскроя необработанных панелей и панелей с покрытием

PRICE LIST

MACCHINA MACHINE TYPES	Cod.	ø D mm	B mm	b mm	ø d mm	Z tot	FT / PH
PANHANS	D103 10	300	4,4	3	30	60	2(10/60)
SELCO	D103 11	300	4,4	3	65	60	2(9/110)
HOMAG	D103 12	300	4,4	3	75	60	-
SCM	D103 13	300	4,4	3	80	60	2(14/110)+4(9/100)
PANHANS	D103 14	300	4,4	3	30	72	2(10/60)
SELCO	D103 15	300	4,4	3	65	72	2(9/110)
HOMAG	D103 16	300	4,4	3	75	72	-
SCM	D103 17	300	4,4	3	80	72	2(14/110)+4(9/100)
MAYER-PANHANS-SCM	D103 18	305	4,4	3	60	60	2(10/60)
SELCO	D103 19	320	4,4	3,2	65	72	2(9/110)
GIBEN	D103 20	320	4,4	3,2	75	72	3/13/95
PANHANS-SCHEER	D103 21	350	4,4	3,2	30	54	2(10/60)
HOLZMA	D103 22	350	4,4	3,2	60	54	2(14/100)
PAHANS-SCHEER	D103 23	350	4,4	3,2	30	72	2(10/60)
GIBEN	D103 24	350	4,4	3,2	50	72	4(13/80)
HOLZMA	D103 25	350	4,4	3,2	60	72	2(14/100)
GABBIANI	D103 26	350	4,4	3,2	80	72	4(9/100)+2(9/110)+2(14/110)
PANHANS-SCM	D103 27	355	4,4	3,2	30	54	2(10/60)
GIBEN	D103 28	355	4,4	3,2	75	54	-
GABBIANI	D103 29	355	4,4	3,2	80	54	4(9/100)+2(9/110)+2(14/110)
PANHANS-SCM	D103 30	355	4,4	3,2	30	72	2(10/60)
GIBEN	D103 31	355	4,4	3,2	75	72	-
GABBIANI	D103 32	355	4,4	3,2	80	72	4(9/100)+2(9/110)+2(14/110)
SELCO	D103 33	360	4,4	3	65	60	2(9/110)
SELCO	D103 34	360	4,4	3,2	65	72	2(9/110)
GIBEN	D103 35	380	4,4	3	50	48	4(13/80)
GABBIANI	D103 36	380	4,4	3	80	48	4(9/100)+2(9/110)+2(14/110)
GIBEN	D103 37	380	4,4	3	50	60	4(13/80)
HOLZMA	D103 38	380	4,4	3,2	60	60	2(14/100)
-	D103 39	380	4,4	3,2	30	72	2(8/83)
GIBEN	D103 40	380	4,4	3,2	50	72	4(13/80)
HOLZMA	D103 41	380	4,4	3,2	60	72	2(14/100)
GABBIANI	D103 42	380	4,4	3,2	80	72	4(9/100)+2(9/110)+2(14/110)
HOLZMA	D103 43	380	4,8	3,5	60	60	2(14/100)
HOLZMA	D103 44	380	4,8	3,5	60	72	2(14/100)
HOLZMA	D103 45	380	4,8	3,5	60	84	2(14/100)
-	D103 46	400	4,4	3	30	48	-
GIBEN	D103 47	400	4,4	3	75	48	4(15/105)
SELCO	D103 48	400	4,4	3	80	48	4(19/120)+2(9/130)
GABBIANI	D103 49	400	4,4	3	80	48	4(9/100)+2(9/110)+2(14/110)
-	D103 50	400	4,4	3,2	30	60	2(10/60)

MACCHINA MACHINE TYPES	Cod.	ø D mm	B mm	b mm	ø d mm	Z tot	FT / PH
GIBEN	D103 51	400	4,4	3,2	75	60	4(15/105)
SELCO	D103 52	400	4,4	3,2	80	60	4(19/120)+2(9/130)
GABBIANI	D103 53	400	4,4	3,2	80	60	4(9/100)+2(9/110)+2(14/110)
SCHEER	D103 54	400	4,4	3,2	30	72	2(10/60)
GIBEN	D103 55	400	4,4	3,2	75	72	4(15/105)
SELCO	D103 56	400	4,4	3,2	80	72	4(19/120)+2(9/130)
GABBIANI	D103 57	400	4,4	3,2	80	72	4(9/100)+2(9/110)+2(14/110)
HOLZMA	D103 58	400	4,8	3,5	60	72	-
HOLZMA	D103 59	420	4,8	3,5	60	60	2(14/125)
HOLZMA	D103 60	420	4,8	3,5	60	84	3(14/76)
HOLZMA	D103 61	430	4,4	3	30	48	-
GIBEN	D103 62	430	4,4	3,2	75	48	4(15/105)
SELCO+GABBIANI	D103 63	430	4,4	3	80	48	2(9/130)+4(19/120)+2(14/110)
-	D103 64	430	4,4	3	30	60	2(10/60)
GIBEN	D103 65	430	4,4	3,2	75	60	4(15/105)
SELCO+GABBIANI	D103 66	430	4,4	3,2	80	60	2(9/130)+4(19/120)+2(14/110)
-	D103 67	430	4,4	3,2	30	72	-
GIBEN	D103 68	430	4,4	3,2	75	72	4(15/105)
SELCO+GABBIANI	D103 69	430	4,4	3,2	80	72	2(9/130)+4(19/120)+2(14/110)
GIBEN+PRISMATIC	D103 70	430	4,4	3,2	75	96	4(15/105)
MAYER-PANHANS-SCHELLING	D103 71	450	4,4	3	30	48	2(9/60)
HOLZMA	D103 72	450	4,4	3	60	48	2(14/125)
SELCO+GABBIANI	D103 73	450	4,4	3	80	48	2(9/130)+4(19/120)+2(14/110)
MAYER-PANHANS-SCHELLING	D103 74	450	4,4	3	30	60	2(10/60)
HOLZMA	D103 75	450	4,4	3,2	60	60	2(14/125)
SELCO+GABBIANI	D103 76	450	4,4	3,2	80	60	2(9/130)+4(19/120)+2(14/110)
MAYER-PANHANS-SCHELLING	D103 77	450	4,4	3,2	30	72	2(10/60)
HOLZMA	D103 78	450	4,4	3,2	60	72	2(14/125)
SELCO+GABBIANI	D103 79	450	4,4	3,2	80	72	2(9/130)+4(19/120)+2(14/110)
MAYER-PANHANS-SCHELLING	D103 80	450	4,8	3,5	30	48	2(9/60)
HOLZMA	D103 81	450	4,8	3,5	60	48	2(14/125)
SELCO	D103 82	450	4,8	3,5	80	48	2(9/130)+4(19/120)
SCHEER	D103 83	450	4,8	3,5	30	60	2(9/60)
HOLZMA	D103 84	450	4,8	3,5	60	60	2(14/125)
SELCO	D103 85	450	4,8	3,5	80	60	2(9/130)+4(19/120)
SCHEER	D103 86	450	4,8	3,5	30	72	2(9/60)
HOLZMA	D103 87	450	4,8	3,5	60	72	2(14/125)+2(17/100)
SELCO	D103 88	450	4,8	3,5	80	72	2(9/130)+4(19/130)
SHELLING	D103 89	460	4,4	3,5	30	72	2(13/94)
GIBEN	D103 90	470	4,4	3,2	75	48	4(15/105)
GIBEN	D103 91	470	4,4	3,2	75	60	4(15/106)
GIBEN	D103 92	470	4,4	3,2	75	72	4(15/107)
GIBEN	D103 93	470	4,4	3,2	75	96	4(15/108)
SELCO	D103 94	480	4,8	3,5	80	48	2(9/130)+4(19/120)
SELCO	D103 95	480	4,8	3,5	80	60	2(9/130)+4(19/120)
SHELLING	D103 96	480	4,8	3,5	30	72	2(10/60)
SELCO	D103 97	480	4,8	3,5	80	72	2(9/130)+4(19/120)
SHELLING	D103 98	500	4,4	3,2	30	48	-
GABBIANI	D103 99	500	4,4	3,2	80	48	4(9/100)+2(9/110)+2(14/110)
SHELLING	D103 100	500	4,4	3,2	30	60	-
GABBIANI	D103 101	500	4,4	3,2	80	60	4(9/100)+2(9/110)+2(14/110)
SHELLING	D103 102	500	4,4	3,2	30	72	-
SHELLING	D103 103	500	4,8	3,5	30	48	-
HOLZMA	D103 104	500	4,8	3,5	60	48	2(11/115)
GIBEN	D103 105	500	4,8	3,5	75	48	4(15/105)
HOLZMA	D103 106	500	4,8	3,5	60	60	2(11/115)
GIBEN	D103 107	500	4,8	3,5	75	60	4(15/105)
HOLZMA	D103 108	500	4,8	3,5	60	72	2(11/115)
GIBEN	D103 109	500	4,8	3,5	75	72	4(15/105)
HOLZMA	D103 110	520	4,8	3,5	60	48	2(19/120)+2(11/115)
HOLZMA	D103 111	520	4,8	3,5	60	60	2(19/120)+2(11/115)
HOLZMA	D103 112	520	4,8	3,5	60	72	2(19/120)+2(11/115)

Low noise DP diamond blade, H6 mm, for panel sizing saws

Diamantblatt (geräuscharm) für Plattenaufteilmaschinen PKD H 6 mm

Hoja silenciosa de diamante con plaquita en DP de H 6 mm para seccionadora

Lame en diamant silencieuse pour scies à panneaux, DP H6 mm

Алмазная шумопонижающая пила для станка DP H6 mm

Section INDEX

INDEX by article

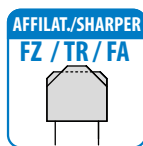
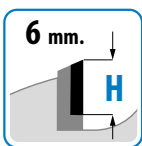

Lama in diamante DP H6mm con corpo in acciaio speciale per ridurre la rumorosità (silenziosa) per macchine squadratrici, sezionatrici, per taglio di pannelli grezzi e rivestiti con l'ausilio dell'incisore

Diamantblatt PKD H 6 mm mit Körper aus Sonderstahl zur Geräuschreduzierung (geräuscharm) für Formatkreissäge(maschinen), Plattenaufteilmaschinen, zum Aufteilen von unbeschichteten und beschichteten Platten mit Vorritzer

Lame en diamant, DP H6 mm avec corps en acier spécial pour réduire le bruit (silencieuse) pour scies à format, scies à panneaux, pour la coupe de panneaux bruts et revêtus, grâce à l'inciseur.

DP diamond blade, H6 mm, with special steel body designed to reduce noise levels (low noise) for squaring and panel sizing saws, also for cutting raw and laminated panels in conjunction with scoring blade

Hoja de diamante con plaquita en DP de H 6 mm y cuerpo de acero especial para reducir el ruido (silenciosa). Es ideal para el escuadrado, seccionado y corte de paneles brutos y revestidos con la ayuda de la sierra grabadora.

Алмазная шумопонижающая пила DP H6 mm с корпусом из специальной стали для 4-х сторонних и форматно-раскроечных станков, для раскроя необработанных панелей и панелей с покрытием.

PRICE LIST

MACCHINA MACHINE TYPES	Cod.	ø D mm	B mm	b mm	ø d mm	Z tot	FT / PH
PANHANS	D104 10	300	4,4	3	30	60	2(10/60)
SELCO	D104 11	300	4,4	3	65	60	2(9/110)
HOMAG	D104 12	300	4,4	3	75	60	-
SCM	D104 13	300	4,4	3	80	60	2(14/110)+4(9/100)
PANHANS	D104 14	300	4,4	3	30	72	2(10/60)
SELCO	D104 15	300	4,4	3	65	72	2(9/110)
HOMAG	D104 16	300	4,4	3	75	72	-
SCM	D104 17	300	4,4	3	80	72	2(14/110)+4(9/100)
MAYER-PANHANS-SCM	D104 18	305	4,4	3	60	60	2(10/60)
SELCO	D104 19	320	4,4	3,2	65	72	2(9/110)
GIBEN	D104 20	320	4,4	3,2	75	72	3/13/95
PANHANS-SCHEER	D104 21	350	4,4	3,2	30	54	2(10/60)
HOLZMA	D104 22	350	4,4	3,2	60	54	2(14/100)
PAHANS-SCHEER	D104 23	350	4,4	3,2	30	72	2(10/60)
GIBEN	D104 24	350	4,4	3,2	50	72	4(13/80)
HOLZMA	D104 25	350	4,4	3,2	60	72	2(14/100)
GABBIANI	D104 26	350	4,4	3,2	80	72	4(9/100)+2(9/110)+2(14/110)
PANHANS-SCM	D104 27	355	4,4	3,2	30	54	2(10/60)
GIBEN	D104 28	355	4,4	3,2	75	54	-
GABBIANI	D104 29	355	4,4	3,2	80	54	4(9/100)+2(9/110)+2(14/110)
PANHANS-SCM	D104 30	355	4,4	3,2	30	72	2(10/60)
GIBEN	D104 31	355	4,4	3,2	75	72	-
GABBIANI	D104 32	355	4,4	3,2	80	72	4(9/100)+2(9/110)+2(14/110)
SELCO	D104 33	360	4,4	3	65	60	2(9/110)
SELCO	D104 34	360	4,4	3,2	65	72	2(9/110)
GIBEN	D104 35	380	4,4	3	50	48	4(13/80)
GABBIANI	D104 36	380	4,4	3	80	48	4(9/100)+2(9/110)+2(14/110)
GIBEN	D104 37	380	4,4	3	50	60	4(13/80)
HOLZMA	D104 38	380	4,4	3,2	60	60	2(14/100)
-	D104 39	380	4,4	3,2	30	72	2(8/83)
GIBEN	D104 40	380	4,4	3,2	50	72	4(13/80)
HOLZMA	D104 41	380	4,4	3,2	60	72	2(14/100)
GABBIANI	D104 42	380	4,4	3,2	80	72	4(9/100)+2(9/110)+2(14/110)
HOLZMA	D104 43	380	4,8	3,5	60	60	2(14/100)
HOLZMA	D104 44	380	4,8	3,5	60	72	2(14/100)
HOLZMA	D104 45	380	4,8	3,5	60	84	2(14/100)
-	D104 46	400	4,4	3	30	48	-
GIBEN	D104 47	400	4,4	3	75	48	4(15/105)
SELCO	D104 48	400	4,4	3	80	48	4(19/120)+2(9/130)
GABBIANI	D104 49	400	4,4	3	80	48	4(9/100)+2(9/110)+2(14/110)
-	D104 50	400	4,4	3,2	30	60	2(10/60)

MACCHINA MACHINE TYPES	Cod.	ø D mm	B mm	b mm	ø d mm	Z tot	FT / PH
GIBEN	D104 51	400	4,4	3,2	75	60	4(15/105)
SELCO	D104 52	400	4,4	3,2	80	60	4(19/120)+2(9/130)
GABBIANI	D104 53	400	4,4	3,2	80	60	4(9/100)+2(9/110)+2(14/110)
SCHEER	D104 54	400	4,4	3,2	30	72	2(10/60)
GIBEN	D104 55	400	4,4	3,2	75	72	4(15/105)
SELCO	D104 56	400	4,4	3,2	80	72	4(19/120)+2(9/130)
GABBIANI	D104 57	400	4,4	3,2	80	72	4(9/100)+2(9/110)+2(14/110)
HOLZMA	D104 58	400	4,8	3,5	60	72	-
HOLZMA	D104 59	420	4,8	3,5	60	60	2(14/125)
HOLZMA	D104 60	420	4,8	3,5	60	84	3(14/76)
HOLZMA	D104 61	430	4,4	3	30	48	-
GIBEN	D104 62	430	4,4	3,2	75	48	4(15/105)
SELCO+GABBIANI	D104 63	430	4,4	3	80	48	2(9/130)+4(19/120)+2(14/110)
-	D104 64	430	4,4	3	30	60	2(10/60)
GIBEN	D104 65	430	4,4	3,2	75	60	4(15/105)
SELCO+GABBIANI	D104 66	430	4,4	3,2	80	60	2(9/130)+4(19/120)+2(14/110)
	D104 67	430	4,4	3,2	30	72	-
GIBEN	D104 68	430	4,4	3,2	75	72	4(15/105)
SELCO+GABBIANI	D104 69	430	4,4	3,2	80	72	2(9/130)+4(19/120)+2(14/110)
GIBEN+PRISMATIC	D104 70	430	4,4	3,2	75	96	4(15/105)
MAYER-PANHANS-SCHELLING	D104 71	450	4,4	3	30	48	2(9/60)
HOLZMA	D104 72	450	4,4	3	60	48	2(14/125)
SELCO+GABBIANI	D104 73	450	4,4	3	80	48	2(9/130)+4(19/120)+2(14/110)
MAYER-PANHANS-SCHELLING	D104 74	450	4,4	3	30	60	2(10/60)
HOLZMA	D104 75	450	4,4	3,2	60	60	2(14/125)
SELCO+GABBIANI	D104 76	450	4,4	3,2	80	60	2(9/130)+4(19/120)+2(14/110)
MAYER-PANHANS-SCHELLING	D104 77	450	4,4	3,2	30	72	2(10/60)
HOLZMA	D104 78	450	4,4	3,2	60	72	2(14/125)
SELCO+GABBIANI	D104 79	450	4,4	3,2	80	72	2(9/130)+4(19/120)+2(14/110)
MAYER-PANHANS-SCHELLING	D104 80	450	4,8	3,5	30	48	2(9/60)
HOLZMA	D104 81	450	4,8	3,5	60	48	2(14/125)
SELCO	D104 82	450	4,8	3,5	80	48	2(9/130)+4(19/120)
SCHEER	D104 83	450	4,8	3,5	30	60	2(9/60)
HOLZMA	D104 84	450	4,8	3,5	60	60	2(14/125)
SELCO	D104 85	450	4,8	3,5	80	60	2(9/130)+4(19/120)
SCHEER	D104 86	450	4,8	3,5	30	72	2(9/60)
HOLZMA	D104 87	450	4,8	3,5	60	72	2(14/125)+2(17/100)
SELCO	D104 88	450	4,8	3,5	80	72	2(9/130)+4(19/130)
SCHELLING	D104 89	460	4,4	3,5	30	72	2(13/94)
GIBEN	D104 90	470	4,4	3,2	75	48	4(15/105)
GIBEN	D104 91	470	4,4	3,2	75	60	4(15/106)
GIBEN	D104 92	470	4,4	3,2	75	72	4(15/107)
GIBEN	D104 93	470	4,4	3,2	75	96	4(15/108)
SELCO	D104 94	480	4,8	3,5	80	48	2(9/130)+4(19/120)
SELCO	D104 95	480	4,8	3,5	80	60	2(9/130)+4(19/120)
SCHELLING	D104 96	480	4,8	3,5	30	72	2(10/60)
SELCO	D104 97	480	4,8	3,5	80	72	2(9/130)+4(19/120)
SCHELLING	D104 98	500	4,4	3,2	30	48	-
GABBIANI	D104 99	500	4,4	3,2	80	48	4(9/100)+2(9/110)+2(14/110)
SCHELLING	D104 100	500	4,4	3,2	30	60	-
GABBIANI	D104 101	500	4,4	3,2	80	60	4(9/100)+2(9/110)+2(14/110)
SCHELLING	D104 102	500	4,4	3,2	30	72	-
SCHELLING	D104 103	500	4,8	3,5	30	48	-
HOLZMA	D104 104	500	4,8	3,5	60	48	2(11/115)
GIBEN	D104 105	500	4,8	3,5	75	48	4(15/105)
HOLZMA	D104 106	500	4,8	3,5	60	60	2(11/115)
GIBEN	D104 107	500	4,8	3,5	75	60	4(15/105)
HOLZMA	D104 108	500	4,8	3,5	60	72	2(11/115)
GIBEN	D104 109	500	4,8	3,5	75	72	4(15/105)
HOLZMA	D104 110	520	4,8	3,5	60	48	2(19/120)+2(11/115)
HOLZMA	D104 111	520	4,8	3,5	60	60	2(19/120)+2(11/115)
HOLZMA	D104 112	520	4,8	3,5	60	72	2(19/120)+2(11/115)

DP diamond conical scoring blade, H4mm

Konischer Diamant-Vorritzer PKD H 4 mm

Hoja de diamante para sierra grabadora cónica con plaquita en DP de H 4 mm

Lame inciseur conique en diamant, DP H4 mm

Пила подрезная конусообразная из алмаза DP H4mm

Section INDEX

INDEX by article

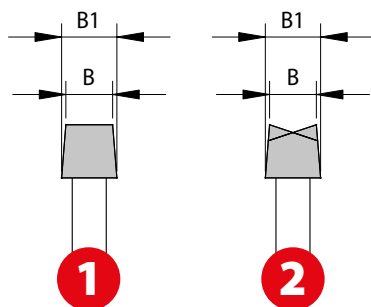
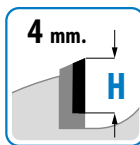

Lama incisore conico in diamante DP H4mm, corpo in acciaio speciale (silenziosa) per l'incisione di pannelli grezzi e rivestiti, per sezionatrici orizzontali e verticali.

DP diamond conical scoring blade, H4mm, with body manufactured from special steel (low noise) for scoring raw and laminated panels on horizontal and vertical sizing saws

Konischer Diamant-Vorritzer PKD H 4 mm, Körper aus Sonderstahl (geräuscharm) zum Vorritzen von beschichteten und unbeschichteten Platten für horizontale und vertikale Plattenaufteilsägen

Hoja de diamante (silenciosa) para sierra grabadora cónica con plaquita en DP de H 4 mm y cuerpo de acero especial para grabar paneles brutos y revestidos así como para seccionadoras horizontales y verticales.

Lame inciseur conique en diamant, DP H4 mm, corps en acier spécial (silencieuse) pour l'incision de panneaux bruts et revêtus, pour scies à panneaux horizontales et verticales.

Пила подрезная конусообразная из алмаза DP H4mm, корпус из специальной стали (низкошумная) для подреза панелей необработанных и панелей с покрытием. Применяется для горизонтальных и вертикальных форматно-раскроечных станков

PRICE LIST

MACCHINA MACHINE TYPES	Cod.	Cod.	ø D mm	B / B1 mm	b mm	ø d mm	Z tot	FT / PH
	Tipo/Type 1	Tipo/Type 2						
	D105 10	D105 110	80	3.1/4.3	2,2	20	12	
	D105 11	D105 111	80	3.1/4.3	2,2	22	12	
SCHELLING	D105 12	D105 112	100	3.1/4.3	2,2	20	24	
	D105 13	D105 113	100	3.1/4.3	2,2	22	24	
	D105 14	D105 114	110	3.1/4.3	2,2	20	24	
	D105 15	D105 115	110	3.1/4.3	2,2	22	24	
	D105 16	D105 116	115	3.1/4.3	2,2	20	24	
	D105 17	D105 117	115	3.1/4.3	2,2	22	24	
SCHELLING	D105 18	D105 118	120	2.8/4	2.2	20	24	
	D105 19	D105 119	120	2.8/4	2.2	22	24	
	D105 20	D105 120	120	3.1/4.3	2.2	20	24	
	D105 21	D105 121	120	3.1/4.3	2.2	22	24	
	D105 22	D105 122	120	3.4/4.6	2.2	20	24	
PANHANS 693 EURO 5 MARTIN	D105 23	D105 123	125	3.1/4.3	2.2	20	24	
	D105 24	D105 124	125	3.1/4.3	2.2	22	24	
	D105 25	D105 125	125	3.4/4.6	2.2	20	24	
	D105 26	D105 126	125	3.4/4.6	2.2	45	24	
PANHANS 693 EURO 5 GIBEN-HOMAG	D105 27	D105 127	125	3.4/4.6	2.2	20	24	
	D105 28	D105 128	125	3.4/4.6	2.2	45	24	
GIBEN-HOMAG	D105 29	D105 129	125	3.4/4.6	2.2	20	24	
	D105 30	D105 130	125	3.4/4.6	2.2	45	24	
SCHEER FM	D105 31	D105 131	140	3.4/4.6	2.2	16	28	1(6/33)
	D105 32	D105 132	140	3.4/4.6	2.2	45	24	
EUROMAC	D105 33	D105 133	140	3.4/4.6	2.2	45	28	
	D105 34	D105 134	140	3.4/4.6	2.2	45	24	
SCM	D105 35	D105 135	150	3.4/4.6	2.2	30	36	
	D105 36	D105 136	150	3.4/4.6	2.2	30	36	



# Art. D105



MACCHINA MACHINE TYPES	Cod. Tipo/Type 1	Cod. Tipo/Type 2	ø D mm	B / B1 mm	b mm	ø d mm	Z tot	FT / PH
SCM	D105 37	D105 137	150	3.4/4.6	2.2	30	36	
SCM	D105 38	D105 138	150	3.4/4.6	2.2	45	36	
SCM	D105 39	D105 139	150	3.4/4.6	2.2	30	36	
SCM	D105 40	D105 140	150	3.4/4.6	2.2	45	36	
LANGZAUNER	D105 41	D105 141	160	3.4/4.6	2.2	20	36	
	D105 42	D105 142	160	3.4/4.6	2.2	25,4	36	
LANGZAUNER	D105 43	D105 143	160	3.4/4.6	2.2	30	36	
GIBEN	D105 44	D105 144	160	3.4/4.6	2.2	45	36	3(11/70)
GABBIANI	D105 45	D105 145	160	3.4/4.6	2.2	55	36	3(7/66)+3(6/84)
	D105 46	D105 146	160	3.4/4.6	2.2	60	36	3(7/80)
GIBEN	D105 47	D105 147	160	3.4/4.6	2.2	45	36	3(11/70)
GABBIANI	D105 48	D105 148	160	3.4/4.6	2.2	55	36	3(7/66)+3(9/72)
	D105 49	D105 149	160	3.4/4.6	2.2	60	36	3(7/80)
SCHEER FM	D105 50	D105 150	180	3.4/4.6	2.2	16	42	1(6/33)
	D105 51	D105 151	180	3.4/4.6	2.2	25,4	36	
SCHELLING-ANTHON	D105 52	D105 152	180	4.3/5.5	3.2	20	28	
PANHANS 693	D105 53	D105 153	180	4.3/5.5	3.2	30	28	2(7/42)+2(10/60)
HOLZMA	D105 54	D105 154	180	4.3/5.5	3.2	45	36	
GIBEN	D105 55	D105 155	180	4.3/5.5	3.2	50	36	3(13/80)
SCHELLING-ANTHON	D105 56	D105 156	180	4.3/5.5	3.2	20	36	
HOLZMA	D105 57	D105 157	180	4.3/5.5	3.2	45	36	
GABBIANI	D105 58	D105 158	180	4.3/5.5	3.2	55	36	3(7/66)
HOLZMA	D105 59	D105 159	180	4.3/5.5	3.2	20	36	
ANTHON LNC	D105 60	D105 160	180	4.3/5.5	3.2	20	36	
SCHELLING	D105 61	D105 161	200	4.3/5.5	3.2	20	36	
	D105 62	D105 162	200	4.3/5.5	3.2	22	36	
SCHEER	D105 63	D105 163	200	4.3/5.5	3.2	30	36	2(9/60)
HOLZMA	D105 64	D105 164	200	4.3/5.5	3.2	45	36	
GIBEN SMART	D105 65	D105 165	200	4.3/5.5	3.2	50	36	3(13/80)
SELCO	D105 66	D105 166	200	4.3/5.5	3.2	65	36	2(9/100)+2(9/110)
GABBIANI	D105 67	D105 167	200	4.3/5.5	3.2	80	36	2(14/110)
	D105 68	D105 168	200	4.3/5.5	3.2	22	36	
SELCO	D105 69	D105 169	200	4.3/5.5	3.2	65	36	2(8,5/110)
	D105 70	D105 170	200	4.3/5.5	3.2	20	36	
	D105 71	D105 171	200	4.3/5.5	3.2	22	36	
SCHEER	D105 72	D105 172	200	4.3/5.5	3.2	30	36	2(9/60)
HOLZMA	D105 73	D105 173	200	4.3/5.5	3.2	45	36	
SELCO	D105 74	D105 174	200	4.3/5.5	3.2	65	36	2(9/100)+2(9/110)
SCHELLING	D105 75	D105 175	200	4.3/5.5	3.2	20	36	
	D105 76	D105 176	200	4.3/5.5	3.2	20	36	
HOLZMA	D105 77	D105 177	200	4.3/5.5	3.2	45	36	
SCHELLING	D105 78	D105 178	200	4.3/5.5	3.2	20	36	
HOLZMA	D105 79	D105 179	200	4.3/5.5	3.2	45	36	
GIBEN	D105 80	D105 180	215	4.3/5.5	3.2	50	42	2(7/80)
GIBEN	D105 81	D105 181	215	4.3/5.5	3.2	50	42	3(15/80)
SCHELLING	D105 82	D105 182	220	4.3/5.5	3.2	20	36	
GIBEN	D105 83	D105 183	300	4.3/5.5	3.2	50	48	3(15/80)
SELCO	D105 84	D105 184	300	4.3/5.5	3.2	65	72	2(9/110)
	D105 85	D105 185	300	4.3/5.5	3.2	80	72	2(14/110)
	D105 86	D105 186	320	4.3/5.5	3.2	45	48	
	D105 87	D105 187	320	4.3/5.5	3.2	45	48	
	D105 88	D105 188	320	4.3/5.5	3.2	50	48	3(15/80)
HOLZMA	D105 89	D105 189	340	4.7/5.9	3.5	45	72	3(14/65)

DP diamond conical scoring blade, H6mm

Konischer Diamant-Vorritzer PKD H 6 mm

Hoja de diamante para sierra grabadora cónica con plaquita en DP de H 6 mm

Lame inciseur conique en diamant, DP H6 mm

Пила подрезная конусообразная из алмаза DP H6mm

Section INDEX

INDEX by article

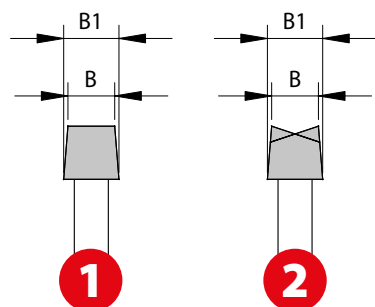
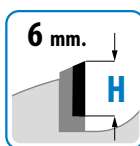

Lama incisore conico in diamante DP H6mm, corpo in acciaio speciale (silenziosa) per l'incisione di pannelli grezzi e rivestiti, per sezionatrici orizzontali e verticali.

DP diamond conical scoring blade, H6mm, with body manufactured from special steel (low noise) for scoring raw and laminated panels on horizontal and vertical sizing saws

Konischer Diamant-Vorritzer PKD H 6 mm, Körper aus Sonderstahl (geräuscharm) zum Vorritzen von beschichteten und unbeschichteten Platten für horizontale und vertikale Plattenaufteilsägen

Hoja de diamante (silenciosa) para sierra grabadora cónica con plaquita en DP de H 6 mm y cuerpo de acero especial para grabar paneles brutos y revestidos así como para seccionadoras horizontales y verticales.

Lame inciseur conique en diamant, DP H6 mm, corps en acier spécial (silencieuse) pour l'incision de panneaux bruts et revêtus, pour scies à panneaux horizontales et verticales.

Пила подрезная конусообразная из алмаза DP H6mm, корпус из специальной стали (низкошумная) для подреза панелей необработанных и панелей с покрытием. Применяется для горизонтальных и вертикальных форматно-раскроечных станков

PRICE LIST

MACCHINA MACHINE TYPES	Cod.	Cod.	ø D mm	B / B1 mm	b mm	ø d mm	Z tot	FT / PH
	Tipo/Type 1	Tipo/Type 2						
	D106 10	D106 110	80	3.1/4.3	2,2	20	12	
	D106 11	D106 111	80	3.1/4.3	2,2	22	12	
SCHELLING	D106 12	D106 112	100	3.1/4.3	2,2	20	24	
	D106 13	D106 113	100	3.1/4.3	2,2	22	24	
	D106 14	D106 114	110	3.1/4.3	2,2	20	24	
	D106 15	D106 115	110	3.1/4.3	2,2	22	24	
	D106 16	D106 116	115	3.1/4.3	2,2	20	24	
	D106 17	D106 117	115	3.1/4.3	2,2	22	24	
SCHELLING	D106 18	D106 118	120	2.8/4	2.2	20	24	
	D106 19	D106 119	120	2.8/4	2.2	22	24	
	D106 20	D106 120	120	3.1/4.3	2.2	20	24	
	D106 21	D106 121	120	3.1/4.3	2.2	22	24	
	D106 22	D106 122	120	3.4/4.6	2.2	20	24	
	D106 23	D106 123	125	3.1/4.3	2.2	20	24	
PANHANS 693 EURO 5 MARTIN	D106 24	D106 124	125	3.1/4.3	2.2	22	24	
	D106 25	D106 125	125	3.4/4.6	2.2	20	24	
PANHANS 693 EURO 5 GIBEN-HOMAG	D106 26	D106 126	125	3.4/4.6	2.2	45	24	
	D106 27	D106 127	125	3.4/4.6	2.2	20	24	
GIBEN-HOMAG	D106 28	D106 128	125	3.4/4.6	2.2	45	24	
	D106 29	D106 129	125	3.4/4.6	2.2	20	24	
SCHEER FM	D106 30	D106 130	125	3.4/4.6	2.2	45	24	
	D106 31	D106 131	140	3.4/4.6	2.2	16	28	1(6/33)
EUROMAC	D106 32	D106 132	140	3.4/4.6	2.2	45	24	
	D106 33	D106 133	140	3.4/4.6	2.2	45	28	
SCM	D106 34	D106 134	140	3.4/4.6	2.2	45	24	
	D106 35	D106 135	150	3.4/4.6	2.2	30	36	
SCM	D106 36	D106 136	150	3.4/4.6	2.2	30	36	

# Art. D106

Section  
INDEX

INDEX  
by article

MACCHINA MACHINE TYPES	Cod. Tipo/Type 1	Cod. Tipo/Type 2	ø D mm	B / B1 mm	b mm	ø d mm	Z tot	FT / PH
SCM	D106 37	D106 137	150	3.4/4.6	2.2	30	36	
SCM	D106 38	D106 138	150	3.4/4.6	2.2	45	36	
SCM	D106 39	D106 139	150	3.4/4.6	2.2	30	36	
SCM	D106 40	D106 140	150	3.4/4.6	2.2	45	36	
LANGZAUNER	D106 41	D106 141	160	3.4/4.6	2.2	20	36	
	D106 42	D106 142	160	3.4/4.6	2.2	25,4	36	
LANGZAUNER	D106 43	D106 143	160	3.4/4.6	2.2	30	36	
GIBEN	D106 44	D106 144	160	3.4/4.6	2.2	45	36	3(11/70)
GABBIANI	D106 45	D106 145	160	3.4/4.6	2.2	55	36	3(7/66)+3(6/84)
	D106 46	D106 146	160	3.4/4.6	2.2	60	36	3(7/80)
GIBEN	D106 47	D106 147	160	3.4/4.6	2.2	45	36	3(11/70)
GABBIANI	D106 48	D106 148	160	3.4/4.6	2.2	55	36	3(7/66)+3(9/72)
	D106 49	D106 149	160	3.4/4.6	2.2	60	36	3(7/80)
SCHEER FM	D106 50	D106 150	180	3.4/4.6	2.2	16	42	1(6/33)
	D106 51	D106 151	180	3.4/4.6	2.2	25,4	36	
SCHELLING-ANTHON	D106 52	D106 152	180	4.3/5.5	3.2	20	28	
PANHANS 693	D106 53	D106 153	180	4.3/5.5	3.2	30	28	2(7/42)+2(10/60)
HOLZMA	D106 54	D106 154	180	4.3/5.5	3.2	45	36	
GIBEN	D106 55	D106 155	180	4.3/5.5	3.2	50	36	3(13/80)
SCHELLING-ANTHON	D106 56	D106 156	180	4.3/5.5	3.2	20	36	
HOLZMA	D106 57	D106 157	180	4.3/5.5	3.2	45	36	
GABBIANI	D106 58	D106 158	180	4.3/5.5	3.2	55	36	3(7/66)
HOLZMA	D106 59	D106 159	180	4.3/5.5	3.2	20	36	
ANTHON LNC	D106 60	D106 160	180	4.3/5.5	3.2	20	36	
SCHELLING	D106 61	D106 161	200	4.3/5.5	3.2	20	36	
	D106 62	D106 162	200	4.3/5.5	3.2	22	36	
SCHEER	D106 63	D106 163	200	4.3/5.5	3.2	30	36	2(9/60)
HOLZMA	D106 64	D106 164	200	4.3/5.5	3.2	45	36	
GIBEN SMART	D106 65	D106 165	200	4.3/5.5	3.2	50	36	3(13/80)
SELCO	D106 66	D106 166	200	4.3/5.5	3.2	65	36	2(9/100)+2(9/110)
GABBIANI	D106 67	D106 167	200	4.3/5.5	3.2	80	36	2(14/110)
	D106 68	D106 168	200	4.3/5.5	3.2	22	36	
SELCO	D106 69	D106 169	200	4.3/5.5	3.2	65	36	2(8,5/110)
	D106 70	D106 170	200	4.3/5.5	3.2	20	36	
	D106 71	D106 171	200	4.3/5.5	3.2	22	36	
SCHEER	D106 72	D106 172	200	4.3/5.5	3.2	30	36	2(9/60)
HOLZMA	D106 73	D106 173	200	4.3/5.5	3.2	45	36	
SELCO	D106 74	D106 174	200	4.3/5.5	3.2	65	36	2(9/100)+2(9/110)
SCHELLING	D106 75	D106 175	200	4.3/5.5	3.2	20	36	
	D106 76	D106 176	200	4.3/5.5	3.2	20	36	
HOLZMA	D106 77	D106 177	200	4.3/5.5	3.2	45	36	
SCHELLING	D106 78	D106 178	200	4.3/5.5	3.2	20	36	
HOLZMA	D106 79	D106 179	200	4.3/5.5	3.2	45	36	
GIBEN	D106 80	D106 180	215	4.3/5.5	3.2	50	42	2(7/80)
GIBEN	D106 81	D106 181	215	4.3/5.5	3.2	50	42	3(15/80)
SCHELLING	D106 82	D106 182	220	4.3/5.5	3.2	20	36	
GIBEN	D106 83	D106 183	300	4.3/5.5	3.2	50	48	3(15/80)
SELCO	D106 84	D106 184	300	4.3/5.5	3.2	65	72	2(9/110)
	D106 85	D106 185	300	4.3/5.5	3.2	80	72	2(14/110)
	D106 86	D106 186	320	4.3/5.5	3.2	45	48	
	D106 87	D106 187	320	4.3/5.5	3.2	45	48	
	D106 88	D106 188	320	4.3/5.5	3.2	50	48	3(15/80)
HOLZMA	D106 89	D106 189	340	4.7/5.9	3.5	45	72	3(14/65)

Adjustable DP diamond scoring blade, H4mm

Verstellbarer Vorritzer aus Diamant PKD H 4 mm

Hoja regulable de diamante para sierra grabadora con plaquita en DP de H 4 mm

Lame inciseur en diamant extensible, DP H4 mm

Алмазная подрезная пила (регулируемая) DP H4mm

Section INDEX

INDEX by article

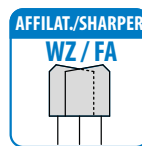
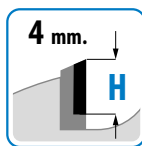
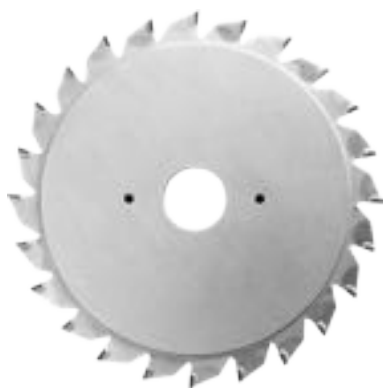

**PRICE LIST**

MACCHINA MACHINE TYPES	Cod.	ø D mm	B mm	ø d mm	Z tot	FT / PH
	D107 10	70	2.8/3.6	20	8+8	2(3,1-3,8/42)
	D107 11	80	2.8/3.6	20	6+6	2(3,1-3,8/42)
	D107 12	80	2.8/3.6	20	10+10	2(3,1-3,8/42)
	D107 13	100	2.8/3.6	20	12+12	2(3,1-3,8/42)
	D107 14	100	2.8/3.6	22	12+12	2(3,1-3,8/42)
	D107 15	100	2.8/3.6	20	12+12	2(3,1-3,8/42)
	D107 16	120	2.8/3.6	20	12+12	2(3,1-3,8/42)
OTTO MARTIN RAPIDO	D107 17	120	2.8/3.6	22	12+12	2(3,1-3,8/42)+4(4,8/38,8) S.I.+4(4,8/54,9)S.I.
CASOLIN	D107 18	120	2.8/3.6	50	12+12	4(6/62)S.I.
ALTENDORF	D107 19	120	2.8/3.6	50	12+12	4(6/62)S.I. SVAS. ANGOLARMENTE
	D107 20	125	2.8/3.6	20	12+12	2(3,1-3,8/42)
	D107 21	125	2.8/3.6	22	12+12	2(3,1-3,8/42)

🇮🇹 Lama incisore in diamante regolabile DP H4mm, corpo in acciaio speciale (silenziosa) per l'incisione di pannelli grezzi e rivestiti per sezionatrici orizzontali e verticali

🇬🇧 Adjustable DP diamond scoring blade, H4mm, with body manufactured from special steel (low noise) for scoring raw and laminated panels on horizontal and vertical sizing saws

🇩🇪 Diamant-Vorritzer, verstellbar, PKD H 4 mm, Körper aus Sonderstahl (geräuscharm) zum Vorritzen von beschichteten und unbeschichteten Platten für horizontale und vertikale Plattenaufteilsägen

🇪🇸 Hoja regulable de diamante (silenciosa) para sierra grabadora con plaquita en DP de H 4 mm y cuerpo de acero especial para grabar paneles brutos y revestidos así como para seccionadoras horizontales y verticales.

🇫🇷 Lame inciseur en diamant extensible, DP H4 mm, corps en acier spécial (silencieuse) pour l'incision de panneaux bruts et revêtus, pour scies à panneaux horizontales et verticales.

🇷🇺 Алмазная подрезная пила (регулируемая) DP H4mm, корпус из специальной стали (низкошумная) для подреза панелей необработанных и панелей с покрытием. Применяется для горизонтальных и вертикальных форматно-раскроечных станков

# Art. D108

## Lama incisore in diamante regolabile DP H6 mm

Section  
INDEX

Adjustable DP diamond scoring blade, H6mm

Verstellbarer Vorritzer aus Diamant PKD H 6 mm

Hoja regulable de diamante para sierra grabadora con plaquita en DP de H 6 mm

Lame inciseur en diamant extensible, DP H6 mm

Алмазная подрезная пила (регулируемая) DP H6mm

INDEX  
by article

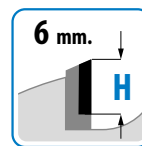
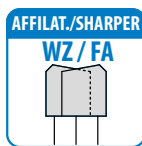

PRICE  
LIST

MACCHINA MACHINE TYPES	Cod.	ø D mm	B mm	ø d mm	Z tot	FT / PH
	D108 10	70	2.8/3.6	20	8+8	2(3,1-3,8/42)
	D108 11	80	2.8/3.6	20	6+6	2(3,1-3,8/42)
	D108 12	80	2.8/3.6	20	10+10	2(3,1-3,8/42)
	D108 13	100	2.8/3.6	20	12+12	2(3,1-3,8/42)
	D108 14	100	2.8/3.6	22	12+12	2(3,1-3,8/42)
	D108 15	100	2.8/3.6	20	12+12	2(3,1-3,8/42)
	D108 16	120	2.8/3.6	20	12+12	2(3,1-3,8/42)
OTTO MARTIN RAPIDO	D108 17	120	2.8/3.6	22	12+12	2(3,1-3,8/42)+4(4,8/38,8) S.I.+4(4,8/54,9)S.I.
CASOLIN	D108 18	120	2.8/3.6	50	12+12	4(6/62)S.I.
ALTENDORF	D108 19	120	2.8/3.6	50	12+12	4(6/62)S.I. SVAS. ANGOLARMENTE
	D108 20	125	2.8/3.6	20	12+12	2(3,1-3,8/42)
	D108 21	125	2.8/3.6	22	12+12	2(3,1-3,8/42)

Lama incisore in diamante regolabile DP H6 mm, corpo in acciaio speciale (silenziosa) per l'incisione di pannelli grezzi e rivestiti per sezionatrici orizzontali e verticali

Adjustable DP diamond scoring blade, H6mm, with body manufactured from special steel (low noise) for scoring raw and laminated panels on horizontal and vertical sizing saws

Diamant-Vorritzer, verstellbar, PKD H 6 mm, Körper aus Sonderstahl (geräuscharm) zum Vorritzen von beschichteten und unbeschichteten Platten für horizontale und vertikale Plattenaufteilsägen

Hoja regulable de diamante (silenciosa) para sierra grabadora con plaquita en DP de H 6 mm y cuerpo de acero especial para grabar paneles brutos y revestidos así como para seccionadoras horizontales y verticales.

Lame inciseur en diamant extensible, DP H6 mm, corps en acier spécial (silencieuse) pour l'incision de panneaux bruts et revêtus, pour scies à panneaux horizontales et verticales.

Алмазная подрезная пила (регулируемая) DP H6mm, корпус из специальной стали (низкошумная) для подреза панелей необработанных и панелей с покрытием. Применяется для горизонтальных и вертикальных форматно-раскроечных станков

# Art. D110

## lama in diamante per materiali duri e abrasivi DP H 4 mm

DP diamond blade for hard and abrasive materials, H 4 mm

Diamantblatt für harte und abrasive Werkstoffe DP H 4 mm

hoja de diamante para materiales duros y abrasivos con plaquita en DP de H 4 mm

Lame en diamant pour matériaux durs et abrasifs DP H 4 mm

Алмазная пила для твёрдых и абразивных материалов DP H 4 mm

Section INDEX

INDEX by article



PRICE LIST

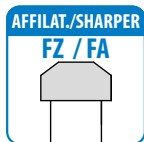
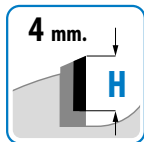

Cod.	ø D mm	B mm	b mm	ø d mm	Z tot	FT / PH
D110 10	160	2,2	1.6	20	4	2(6/32)
D110 11	160	2,2	1.6	20	8	2(6/32)
D110 12	160	2,2	1.6	20	10	2(6/32)
D110 13	180	2,2	1.6	20	4	2(6/32)
D110 14	190	2,2	1.6	20	4	2(7/42)
D110 15	190	2,2	1.6	30	4	2(7/42)
D110 16	190	2,2	1.6	30	12	2(7/42)
D110 17	216	2,2	1.6	30	8	2(7/42)
D110 18	216	2,2	1.6	30	14	2(7/42)
D110 19	230	2,2	1.6	30	4	2(7/42)
D110 20	250	2,2	1.6	30	12	2(7/42)+2(9/46,4)+2(10/60)
D110 21	250	2,2	1.6	30	16	2(7/42)+2(9/46,4)+2(10/60)
D110 22	300	2,2	1.6	30	20	2(7/42)+2(9/46,4)+2(10/60)

Lama in diamante per macchine portatili o a batteria per la lavorazione di materiali abrasivi come fibrocemento, cartongesso e fibrogesso.

Diamantblatt für tragbare oder batteriebetriebene Maschinen zur Bearbeitung von abrasiven Werkstoffen wie Faserverzement, Gips, Fasergips.

Lame en diamant pour machine portatives ou à batterie pour l'usinage de matériaux abrasifs tel que fibrociment, plaques de plâtre et fibre de plâtre.

DP saw blade for portable or battery-powered machines for working on abrasive materials such as fiber cement, plasterboard and fiber cement.

Hoja de diamante para máquinas portátiles o a batería para el mecanizado de materiales abrasivos como fibrocemento, cartongesso y fibrogesso.

Алмазная пила для портативных станков и станков, работающих от аккумулятора для обработки абразивных материалов: фиброцемент, гипсокартон, фиброкартон.

# Art. D111

## lama in diamante corpo in acciaio speciale, affilabile 2 volte

diamond blade, special steel body, sharpenable 2 times

Diamantblatt mit Körper aus Sonderstahl, 2-mal nachschleifbar

hoja de diamante con cuerpo en acero especial, reafilable 2 veces

Lame en diamant corps en acier spécial, affûtable 2 fois

Алмазная пила с корпусом из спец.стали, затачиваемая 2 раза

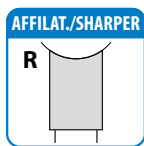

Cod.	ø D mm	B mm	b mm	ø d mm	Z tot	FT / PH
D111 10	160	2,2	1.6	20	20	2(6/32)
D111 11	190	2,5	2	30	24	2(7/42)
D111 12	216	2,5	2	30	30	2(7/42)
D111 13	250	2,5	2	30	36	Combi 3
D111 14	300	2,5	2	30	44	Combi 3

Lama in diamante con corpo in acciaio speciale affilabile 2 volte, adatta per lavorazioni su macchine di qualsiasi tipo, troncatrici, seghe a banco, macchine portatili, sezionatrici verticali e CNC. Per una maggiore perfezione di taglio, si consiglia l'utilizzo dell'incisore.

Hoja de diamante con cuerpo en acero especial, reafilable 2 veces, para mecanizados a realizar en cualquier tipo de máquinas tales como tronadoras, sierras de banco, máquinas portátiles, seccionadoras verticales y CNC. Para mayor perfección de corte, se aconseja el uso de la sierra grabadora.

Diamond blade with special steel body, sharpenable twice, suitable for machining on any type of equipment, cut-off saws, benchtop saws, portable machines, vertical panel saws and CNC. Use of a scoring blade is recommended for greater cutting precision.

Lame en diamant avec corps en acier spécial affûtable 2 fois, adaptée pour l'usinage sur machines de n'importe quels types, tronçonneuses, scies de table, machines portatives, scies à panneaux verticales et CNC. Pour une meilleure perfection de coupe, on conseille l'utilisation de l'inciseur.

Diamantblatt mit Körper aus Sonderstahl, 2-mal nachschleifbar, geeignet für Bearbeitungen auf Maschinen jeder Art, Kappsägemaschinen, Tischkreissägen, handgehaltene Maschinen, vertikale Plattenaufteilsägen und CNC. Für eine höhere Schnittgenauigkeit empfehlen wir die Verwendung des Vorritzers.

Алмазная пила с корпусом из спец.стали, затачиваемая 2 раза подходит для применения на станках любого вида: торцовочных, настольных, вертикальных, портативных и станков с ЧПУ.

PRICE LIST



Section  
INDEX

DP diamond cutters for grooves, H4.5mm

Diamant-Nutfräser PKD H 4,5 mm

Fresas de diamante para ensambles con plaquita en DP de H 4,5 mm

Fraises pour rainures en diamant, DP H4,5 mm

Алмазные фрезы для сращиваний DP H4.5mm

INDEX  
by article

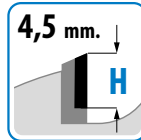

PRICE  
LIST

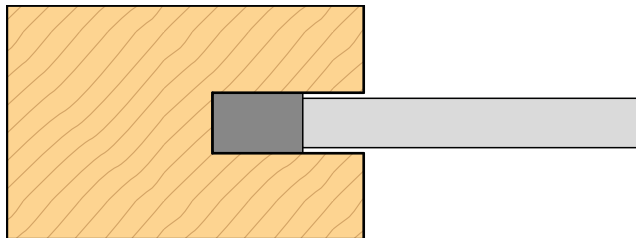

Frese per incastri in diamante DP H4.5mm, costruite con corpo in acciaio speciale per lavorazioni di pannelli truciolare, in MDF grezzi e nobilitati.

DP diamond cutters for grooves, H4.5mm, with body manufactured from special steel, for machining particle-board and MDF panels, raw and laminated.

Diamant-Nutfräser PKD H 4,5 mm, hergestellt mit Körper aus Sonderstahl für Bearbeitungen von beschichteten und unbeschichteten Span- und MDF-Platten.

Fresas de diamante para ensambles con plaquita en DP de H 4,5 mm y cuerpo de acero especial para mecanizar paneles brutos, de MDF, aglomerado y melamina.

Fraises pour rainures en diamant, DP H4,5 mm, construite avec corps en acier spécial pour l'usinage de panneaux agglomérés, MDF bruts et anoblis.

Алмазные фрезы для сращиваний DP H4.5mm, корпус сделан из специальной стали. Применяются для необработанных и шпонируемых ДСП и MDF панелей

Cod.	ø D mm	B mm	ø d mm	Z	rpm max
D490 10	120	3	35	16	10000
D490 11	120	3	40	16	10000
D490 12	120	4	35	16	10000
D490 13	120	4	40	16	10000
D490 14	120	5	35	16	10000
D490 15	120	5	40	16	10000
D490 16	120	6	35	16	10000
D490 17	120	6	40	16	10000
D490 18	120	7	35	16	10000
D490 19	120	7	40	16	10000
D490 20	120	8	35	16	10000
D490 21	120	8	40	16	10000
D490 22	120	9	35	16	10000
D490 23	120	9	40	16	10000
D490 24	120	10	35	16	10000
D490 25	120	10	40	16	10000
D490 26	160	3	35	16	9000
D490 27	160	3	40	16	9000
D490 28	160	4	35	16	9000
D490 29	160	4	40	16	9000
D490 30	160	5	35	16	9000
D490 31	160	5	40	16	9000
D490 32	160	6	35	16	9000
D490 33	160	6	40	16	9000
D490 34	160	7	35	16	9000
D490 35	160	7	40	16	9000
D490 36	160	8	35	16	9000
D490 37	160	8	40	16	9000
D490 38	160	9	35	16	9000
D490 39	160	9	40	16	9000
D490 40	160	10	35	16	9000
D490 41	160	10	40	16	9000
D490 42	180	3	35	16	8500
D490 43	180	3	40	16	8500
D490 44	180	4	35	16	8500
D490 45	180	4	40	16	8500
D490 46	180	5	35	16	8500
D490 47	180	5	40	16	8500
D490 48	180	6	35	16	8500
D490 49	180	6	40	16	8500
D490 50	180	7	35	16	8500
D490 51	180	7	40	16	8500
D490 52	180	8	35	16	8500
D490 53	180	8	40	16	8500
D490 54	180	9	35	16	8500
D490 55	180	9	40	16	8500
D490 56	180	10	35	16	8500
D490 57	180	10	40	16	8500
D490 58	200	3	35	16	8000
D490 59	200	3	40	16	8000
D490 60	200	4	35	16	8000
D490 61	200	4	40	16	8000
D490 62	200	5	35	16	8000
D490 63	200	5	40	16	8000
D490 64	200	6	35	16	8000
D490 65	200	6	40	16	8000
D490 66	200	7	35	16	8000
D490 67	200	7	40	16	8000
D490 68	200	8	35	16	8000
D490 69	200	8	40	16	8000
D490 70	200	9	35	16	8000
D490 71	200	9	40	16	8000
D490 72	200	10	35	16	8000
D490 73	200	10	40	16	8000

Adjustable DP diamond cutter for grooves, H4.5mm

Diamant-Nutfräser, stellbar, PKD H 4,5 mm

ver-

Fresa regulable de diamante para ensambles con plaquita en DP de H 4,5 mm

Fraises pour rainures extensibles en diamant, DP H4,5 mm

Фреза для сращиваний (регулируемая) из алмаза DP H4.5mm

Section INDEX

INDEX by article



ANGOLO ASSIALE  
AXIAL ANGLE  
**30°**

4,5 mm.  
H

SYMMETRIC

PRICE LIST

Cod.	ø D mm	B mm	ø d mm	Z	rpm max
D435 10	120	4:7,5	35	8 + 8	10000
D435 11	120	4:7,5	40	8 + 8	10000
D435 12	120	6:11,5	35	8 + 8	10000
D435 13	120	6:11,5	40	8 + 8	10000
D435 14	160	4:7,5	35	8 + 8	9000
D435 15	160	4:7,5	40	8 + 8	9000
D435 16	160	6:11,5	35	8 + 8	9000
D435 17	160	6:11,5	40	8 + 8	9000
D435 18	180	4:7,5	35	8 + 8	8500
D435 19	180	4:7,5	40	8 + 8	8500
D435 20	180	6:11,5	35	8 + 8	8500
D435 21	180	6:11,5	40	8 + 8	8500
D435 22	200	4:7,5	35	8 + 8	8000
D435 23	200	4:7,5	40	8 + 8	8000
D435 24	200	6:11,5	35	8 + 8	8000
D435 25	200	6:11,5	40	8 + 8	8000
D435 26	200	4:7,5	35	12 + 12	8000
D435 27	200	4:7,5	40	12 + 12	8000
D435 28	200	6:11,5	35	12 + 12	8000
D435 29	200	6:11,5	40	12 + 12	8000

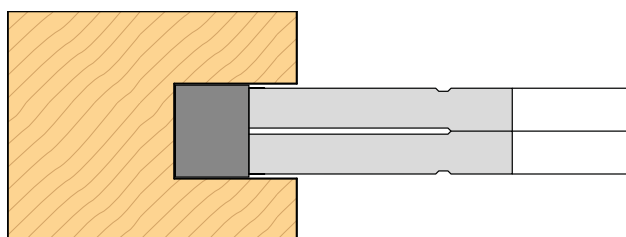

Fresa per incastri regolabile in diamante DP H4.5mm con corpo in acciaio speciale regolabile tramite anelli distanziali per lavorazioni di incastri su pannelli di truciolare, MDF, grezzi e nobilitati.

Adjustable DP diamond cutter for grooves, H4.5mm, with body of special steel, adjustable by means of distance rings for grooving operations on raw and laminated particleboard and MDF panels.

Diamant-Nutfräser, verstellbar, PKD H 4,5 mm mit durch Zwischenringe verstellbarem Körper aus Sonderstahl für Bearbeitungen von Nuten auf beschichteten oder unbeschichteten Spanplatten und MDF-Platten

Fresa regulable de diamante para ensambles con plaquita en DP de H 4,5 mm y cuerpo de acero especial regulable mediante anillos distanciadores. Se utiliza para mecanizar ensambles en paneles brutos, de aglomerado, MDF y melamina.

Fraises pour rainures extensibles en diamant, DP H4,5 mm, corps en acier spécial extensible grâce à des bagues d'espacement, pour l'usinage de rainures sur panneaux agglomérés, MDF, bruts et anoblis.

Фреза для сращиваний (регулируемая) из алмаза DP H4.5mm с корпусом из специальной стали. Регулирование при помощи дистанционных колец. Применение: для сращиваний ДСП, МФФ необработанных и шпонируемых панелей



## **FRESE IN DIAMANTE PER FORARE E CONTORNARE PUNTE IN DIAMANTE PER FORARE**



**DIAMOND TOOLS FOR BORING AND CONTOURING  
DIAMOND ROUTERS FOR BORING**

**DIAMANTFRÄSER LÖCHER BOHREN UND FÜGEN  
DIAMANTBOHRER LÖCHER BOHREN**

**FRESAS EN DIAMANTE PARA TALADRAR Y CONTORNEA  
Û BROCA EN DIAMANTE PARA TALADRAR**

**FRAISES EN DIAMANT POUR PERCER ET CONTOURNER  
MECHES EN DIAMANT POUR PERCER**

**ФРЕЗЫ ДЛЯ СВЕРЛЕНИЙ И КОНТУРНОЙ ОБРАБОТК  
АЛМАЗНЫЕ ФРЕЗЫ ДЛЯ СВЕРЛЕНИЙ И**

# frese in diamante per forare e contornare punte in diamante per forare

diamond tools for boring and contouring diamond routers for boring

Diamantfräser Löcher bohren und fügen Diamantbohrer löcher bohren

















Fresas en diamante para taladrar y contornea ù Broca en diamante para taladrar

fraises en diamant pour percer et contourner meches en diamant pour percer

фрезы для сверлений и контурной обработки алмазные фрезы для сверлений и

Section INDEX

INDEX by article

<p><b>Art. D201</b></p> 	<p>pag. 29</p>	<p><b>Art. D246</b></p> 	<p>pag. 31</p>	<p><b>Art. D212</b></p> 	<p>pag. 33</p>	<p><b>Art. D220</b></p> 	<p>pag. 37</p>
<p><b>Art. D203</b></p> 	<p>pag. 29</p>	<p><b>Art. D245</b></p> 	<p>pag. 31</p>	<p><b>Art. D215</b></p> 	<p>pag. 34</p>	<p><b>Art. D221</b></p> 	<p>pag. 38</p>
<p><b>Art. D204</b></p> 	<p>pag. 30</p>	<p><b>Art. D239</b></p> 	<p>pag. 32</p>	<p><b>Art. D216</b></p> 	<p>pag. 35</p>	<p><b>Art. D224</b></p> 	<p>pag. 39</p>
<p><b>Art. D206</b></p> 	<p>pag. 30</p>	<p><b>Art. D213</b></p> 	<p>pag. 32</p>	<p><b>Art. D214</b></p> 	<p>pag. 36</p>	<p><b>Art. D225</b></p> 	<p>pag. 40</p>

# fresе in diamante per forare e contornare punte in diamante per forare

Section  
INDEX

diamond tools for boring and contouring diamond routers for boring

Diamantfräser Löcher bohren und fügen Diamantbohrer löcher bohre

Fresas en diamante para taladrar y contornea ù Broca en diamante para taladrar

fraises en diamant pour percer et contourner meches en diamant pour percer

фрезы для сверлений и контурной обработк алмазные фрезы для сверлений и

INDEX  
by article

**Art. D228**

pag.  
41



**Art. D233**

pag.  
45



**Art. D259**

pag.  
49



**Art. D248**

pag.  
53



**Art. D229**

pag.  
42



**Art. D234**

pag.  
46



**Art. D241**

pag.  
50



**Art. D249**

pag.  
54



**Art. D230**

pag.  
43



**Art. D236**

pag.  
47



**Art. D243**

pag.  
51



**Art. D820**

pag.  
55



**Art. D232**

pag.  
44



**Art. D240**

pag.  
48



**Art. D242**

pag.  
52



**Art. D836**

pag.  
55



# frese in diamante per forare e contornare punte in diamante per forare

diamond tools for boring and contouring diamond routers for boring

Diamantfräser Löcher bohren und fügen Diamantbohrer löcher bohren

Fresas en diamante para taladrar y contornea ù Broca en diamante para taladrar

fraises en diamant pour percer et contourner meches en diamant pour percer

фрезы для сверлений и контурной обработки алмазные фрезы для сверлений и

Section  
INDEX

INDEX  
by article

**Art. D256**

pag.  
56

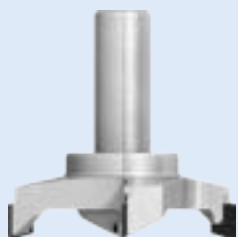

**Art. D833**

pag.  
59



**Art. D703**

pag.  
61



**Art. D252**

pag.  
57



**Art. D109**

pag.  
59



**Art. D705**

pag.  
61



**Art. D309**

pag.  
58



**Art. D701**

pag.  
60



**Art. D704**

pag.  
62



**Art. D351**

pag.  
58



**Art. D702**

pag.  
60



# Art. D201

## fresa in diamante con tagliente diritto Z1 con corpo HW DP H 3,5 mm

Section INDEX

DP diamond router bit with straight cut Z1, HW body, H 3.5 mm

Diamantfräser mit gerader Schneide Z1 und Körper aus HW PKD H 3,5 mm

fresa de diamante con filo cortante recto Z1, cuerpo en HW y plaquita en DP de H 3,5 mm

Fraise diamant avec plaquette droite Z1 corps en HW DP H 3,5 mm

Алмазная фреза, нож прямой Z1 корпус HW DP H 3,5 mm

INDEX by article

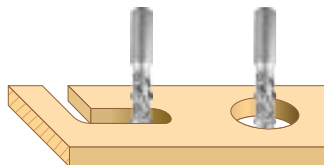
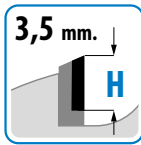
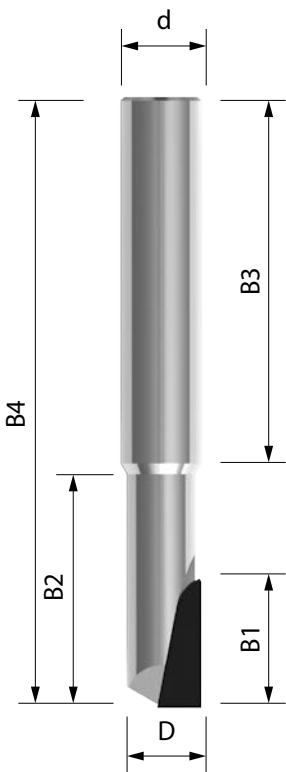

Cod.	D mm	B1 mm	B2 mm	B3 mm	B4 mm	d mm	Z tot	rpm max
D201 10	4	10	18	40	60	5	1	24000
D201 11	5	10	18	40	60	6	1	24000
D201 12	6	12	18	40	60	6	1	24000
D201 13	8	12	24	45	70	8	1	24000
D201 14	8	20	24	45	70	8	1	24000
D201 15	10	15	28	45	75	10	1	24000
D201 16	10	20	28	45	75	10	1	24000
D201 17	12	20	28	45	75	12	1	24000

Fresa in diamante con tagliente diritto Z1, corpo fresa in widia integrale Ottima per lavorazione di pannelli in truciolare, MDF, multistrato, legni senza nodi e materiali polimerici.

DP shank cutter with straight cut Z1 carbide body. Suitable for working on chipboard panels, plywood, laminated, solid wood, corian-polymers and MDF.

Diamantfräser mit gerader Schneide Z1, Schneidkörper vollständig aus Widia. Ideal zur Bearbeitung von Spanplatten, MDF-Platten, Mehrschichtplatten, Holz ohne Knoten und Polymerwerkstoffen.

Fresa de diamante con filo cortante recto Z1 y cuerpo de metal duro integral. Es ideal para mecanizar paneles de aglomerado, MDF, contrachapado, maderas sin nudos y materiales poliméricos.

Fraise diamant avec plaquettes droites, Z1, corps de fraise en vidia intégral. Optimale pour l'usinage de panneaux agglomérés, MDF, multicouches, bois sans nœud et matériaux polymères

Алмазная фреза с прямым ножом Z1, цельный корпус из твёрдосплава. Отличная для обработки древесностружечных плит (ДСП), МДФ, многослойных панелей, древесины без сучков и полимерных материалов.

# Art. D203

## fresa in diamante con tagliente negativo Z1 con corpo HW DP H 3,5 mm

DP diamond router bit with negative cut Z1, HW body, H 3.5 mm

Diamantfräser mit negativem Achswinkel Z1 und Körper aus HW PKD H 3,5 mm

fresa de diamante con filo cortante negativo Z1, cuerpo en HW y plaquita en DP de H 3,5 mm

Fraise diamant avec plaquette négative Z1 corps en HW DP H 3,5 mm

Алмазная фреза, нож отрицательный Z1 корпус HW DP H3,5 mm

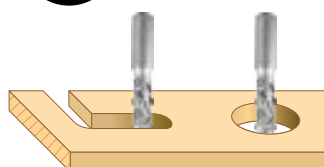
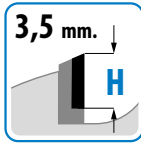
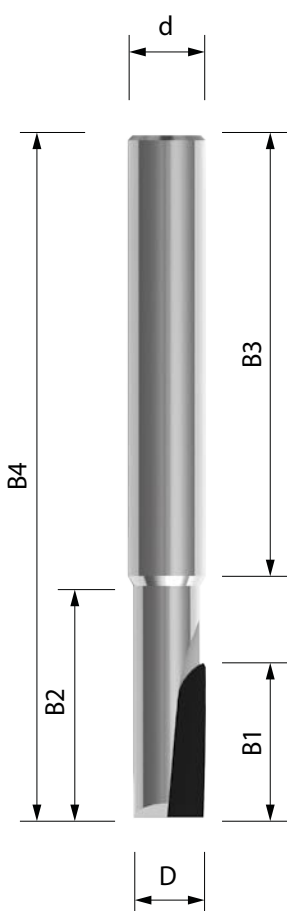

Cod.	D mm	B1 mm	B2 mm	B3 mm	B4 mm	d mm	Z tot	rpm max
D203 10	5	10	19	40	60	6	1	24000
D203 11	6	12	19	40	60	6	1	24000
D203 12	8	12	23	45	70	8	1	24000
D203 13	8	15	23	45	70	8	1	24000
D203 14	8	20	23	45	70	8	1	24000
D203 15	10	15	28	45	75	10	1	24000
D203 16	12	20	28	45	75	12	1	24000

Fresa in diamante con tagliente negativo Z1, corpo fresa in widia integrale. Ottima per esecuzione di canali con massima finitura del pannello superficiale. Ideale per lavorazione di pannelli in truciolare rivestito, laminati, MDF rivestito e multistrato rivestito.

DP shank cutter with negative cut Z1 carbide body. Suitable for grooving with excellent finishing on the panel surface to be used for working on chipboard panel, laminated and MDF.

Diamantfräser mit negativem Achswinkel Z1, Schneidkörper vollständig aus Widia. Ideal zum Nuten bei maximaler Oberflächengüte der oberen Platte. Ideal zur Bearbeitung von beschichteten Spanplatten, Laminat, beschichteten MDF und Mehrschichtplatten.

Fresa de diamante con filo cortante negativo Z1 y cuerpo de metal duro integral. Se utiliza para realizar ranuras garantizando un excelente acabado superficial. Es ideal para mecanizar paneles de aglomerado revestido, laminados, MDF revestido y contrachapado revestido.

Fraise diamant avec plaquettes négatives, Z1, corps de fraise en vidia intégral. Optimale pour l'usinage de rainures avec une extrême finition du panneau superficiel. Idéale pour l'usinage de panneaux agglomérés revêtus, laminés, MDF revêtu et multicouches revêtues.

Алмазная фреза с отрицательным ножом Z1, цельный корпус из твёрдосплава. Отлично подходит для обработки каналов с максимальной отделкой поверхности панели. Идеально подходит для обработки панелей ДСП с меламином, ламината, МДФ с покрытием, многослойных панелей с покрытием.



# Art. D204

## fresa in diamante con tagliente diritto Z2 con corpo HW DP H 3,5 mm

DP diamond router bit with straight cut Z2, HW body, H 3.5 mm

Diamantfräser mit gerader Schneide Z2 und Körper aus HW PKD H 3,5 mm

fresa de diamante con filo cortante recto Z2, cuerpo en HW y plaquita en DP de H 3,5 mm

Fraise diamant avec plaquette droite Z2 corps en HW DP H 3,5 mm

Алмазная фреза, нож прямой Z2 корпус HW DP H 3,5 mm

Section INDEX

INDEX by article

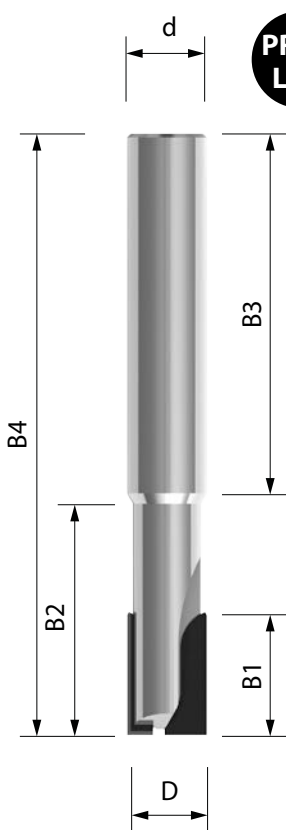

PRICE LIST

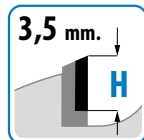

Cod.	D mm	B1 mm	B2 mm	B3 mm	B4 mm	d mm	Z tot	rpm max
D204 10	8	12	24	45	70	8	2	24000
D204 11	8	15	24	45	70	8	2	24000
D204 12	10	15	28	45	75	10	2	24000
D204 13	10	20	28	45	75	10	2	24000
D204 14	12	20	28	45	75	12	2	24000

Fresa in diamante con taglienti dritti Z2, corpo fresa in widia integrale. Ottima per lavorazione di pannelli in truciolare, MDF, multistrato, legni duri senza nodi e materiali polimerici.

DP shank cutter with straight cut Z2 carbide body. Suitable for working on chipboard panels, plywood, laminated, solid wood, corian-polymers and MDF.

Diamantfräser mit geraden Schneiden Z2, Schneidkörper vollständig aus Widia. Ideal zur Bearbeitung von Spanplatten, MDF-Platten, Mehrschichtplatten, Hartholz ohne Knoten und Polymerwerkstoffen.

Fresa de diamante con filos cortantes rectos Z2 y cuerpo de metal duro integral. Es ideal para mecanizar paneles de aglomerado, MDF, contrachapado, maderas duras sin nudos y materiales poliméricos.

Fraise diamant avec plaquettes droites, Z2, corps de fraise en vidia intégral. Optimale pour l'usinage de panneaux agglomérés, MDF, multicouches, bois durs sans nœud et matériaux polymères.

Алмазная фреза с прямыми ножами Z2, цельный корпус из твердосплава. Отличная для обработки древесностружечных плит (ДСП), МДФ, многослойных панелей, древесины твердых пород без сучков и полимерных материалов.

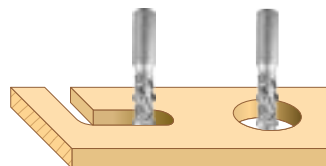

# Art. D206

## fresa in diamante con tagliente negativo Z2 con corpo HW DP H 3,5 mm

DP diamond router bit with negative cut Z2, HW body, H 3.5 mm

Diamantfräser mit negativem Achswinkel Z2 und Körper aus HW PKD H 3,5 mm

fresa de diamante con filo cortante negativo Z2, cuerpo en HW y plaquita en DP de H 3,5 mm

Fraise diamant avec plaquettes négatives Z2 corps en HW DP H 3,5

Алмазная фреза, нож отрицательный Z2 корпус HW DP H 3,5 mm

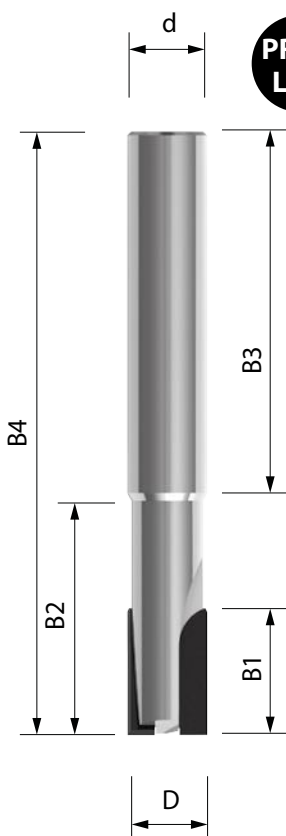

PRICE LIST

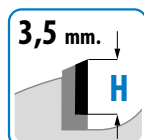
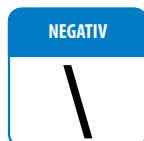

Cod.	D mm	B1 mm	B2 mm	B3 mm	B4 mm	d mm	Z tot	rpm max
D206 10	8	12	24	45	70	8	2	24000
D206 11	8	15	24	45	70	8	2	24000
D206 12	10	15	28	45	75	10	2	24000
D206 13	10	15	28	45	75	12	2	24000
D206 14	10	20	28	45	75	10	2	24000
D206 15	12	20	28	45	75	12	2	24000

Fresa in diamante con taglienti negativi Z2, corpo fresa in widia integrale. Ottima per esecuzione di canali su pannelli con massima finitura superficiale. Ideale per lavorazione di MDF rivestito, truciolare rivestito e multistrato laminato.

DP shank cutter with negative cut Z2 carbide body. Suitable for grooving with excellent finishing on the panel surface to be used for working on chipboard panel, laminated and MDF.

Diamantfräser mit negativem Achswinkel Z2, Schneidkörper vollständig aus Widia. Ideal zum Nuten von Platten bei maximaler Oberflächengüte. Ideal zur Bearbeitung von beschichtetem MDF, beschichteten Spanplatten und laminierten Mehrschichtplatten.

Fresa de diamante con filos cortantes negativos Z2 y cuerpo de metal duro integral. Se utiliza para realizar ranuras en paneles garantizando un excelente acabado superficial. Es ideal para mecanizar paneles de MDF revestido, aglomerado revestido y contrachapado laminado.

Fraise diamant avec plaquettes négatives, Z2, corps de fraise en vidia intégral. Optimale pour l'usinage de rainures avec une extrême finition superficielles. Idéale pour l'usinage de MDF revêtu, aggloméré revêtu et multicouches revêtues.

Алмазная фреза с отрицательными ножами Z2, цельный корпус из твердосплава. Отлично подходит для обработки каналов с максимальной отделкой поверхности панели. Идеально подходит для обработки панелей ДСП с меламином, МДФ со шпоном и многослойных панелей с покрытием.

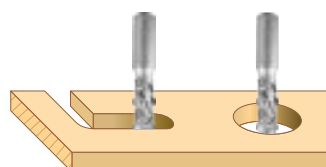

# Art. D246

## fresa in diamante con tagliente positivo negativo Z2 con corpo HW DP H 3,5 mm

Section INDEX

DP diamond router bit with positive+negative cut Z2, HW body, H 3.5 mm

Diamantfräser mit wechselseitigem Achswinkel (positiv/negativ) der Schneiden Z2, Körper aus HW PKD H 3,5 mm

fresa de diamante con filocortante positivo/negativo Z2, cuerpo en HW y plaquita en DP de H 3,5 mm

Fraise diamant avec plaquette alternée positif/négatif Z2 corps en HW DP H 3,5

Алмазная фреза, нож отрицательно-положительный Z2 корпус HW DP H 3,5 mm

INDEX by article

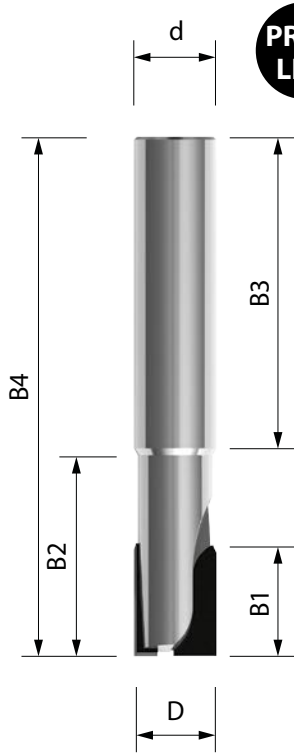

PRICE LIST

ANGOLO ASSIALE AXIAL ANGLE  
**3°/5°**

POSITIV NEGATIV

3,5 mm.  
H

FORANTE / DRILL  
DP

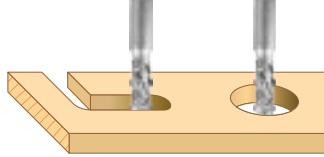

Cod.	D mm	B1 mm	B2 mm	B3 mm	B4 mm	d mm	Z tot	rpm max
D246 10	8	15	24	45	70	8	2	24000
D246 11	10	15	24	45	75	10	2	24000
D246 12	12	15	24	45	75	12	2	24000
D246 13	12	20	24	45	75	12	2	24000

Fresa in diamante Z2 con assialità dei taglianti alternata, (1 tagliente positivo + 1 tagliente negativo), corpo fresa in widia integrale, forante in diamante. Consigliata per lavorazione di materiale compatti come HDF, HPL, pannelli in fibra di carbonio, trespa e corian.

Fresa de diamante Z2 con ángulos axiales alternados de los filos cortantes (1 filo cortante positivo + 1 filo cortante negativo), cuerpo de metal duro integral y broca para taladrar de diamante. Es ideal para mecanizar materiales compactos como paneles de alta densidad (HDF), laminados (HPL), paneles de fibra de carbono, placas Trespa y Corian.

DP shank cutter with alt. cut Z2 (1 positive cut - 1 negative cut) plunge tip in DP carbide body. Suitable for working on compact material HDF HPL corian carbon fiber and trespa.

Fraise diamant Z2 avec plaquettes axiales alternées (1 plaquette positive + 1 plaquette négative), corps de fraise en widia intégral, perceur en diamant. Conseillée pour l'usinage de matériaux compact tels que HDF, HPL, panneaux en fibre de carbone, trespa et corian.

Nachschleifbarer Diamantfräser, mit wechselseitigem Achswinkel (2 positiv + 2 negativ), Schneiden zum Schruppen/Schlichten, PKD H 3,0, Körper aus Schwermetall HDM, geeignet zur Nesting-Bearbeitung von MDF-, HDF-, HPL-, Kohlenstofffaserplatten, Trespa und Corian

Алмазная фреза Z2 с переменной осью ножей, 1 положительный и 1 отрицательный, цельный корпус из твёрдосплав, сверло из алмаза. Рекомендуется для обработки компактных материалов: HDF, HPL, панелей из углеродного волокна, треспы и кориана.

# Art. D245

## fresa in diamante elicoidale Z1+1 con corpo HW DP H 2,5 mm

DP diamond helical router bit Z1+1, HW body, H 2.5 mm

Diamant-Spiralfräser Z1+1 mit Körper aus HW, PKD H 2,5 mm

fresa de diamante helicoidal Z1+1 con cuerpo en HW y plaquita en DP de H 2,5 mm

Fraise diamant hélicoïdale Z1+1 corps en HW DP H 2,5 mm

Алмазная спиральная фреза Z1+1 корпус HW DP H 2,5 mm

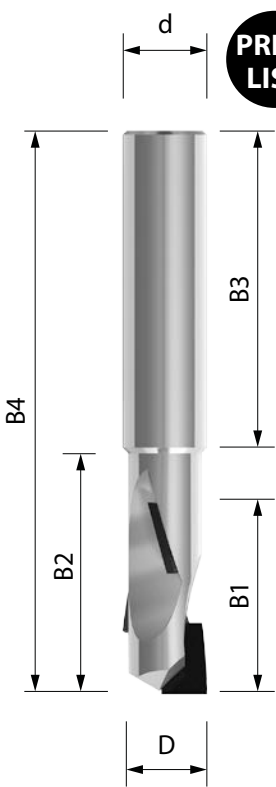

PRICE LIST

ANGOLO ASSIALE AXIAL ANGLE  
**8°/15°**

+ NEGATIV

2,5 mm.  
H

FORANTE / DRILL  
DP

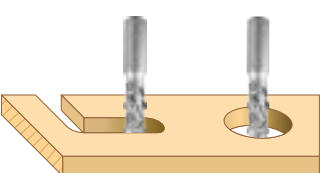

Cod.	D mm	B1 mm	B2 mm	B3 mm	B4 mm	d mm	Z tot	rpm max
D245 10	8	27	34	40	75	8	1+1 (3)	24000
D245 11	8	35	39	40	80	8	1+1 (4)	24000
D245 12	8	44	49	40	90	8	1+1 (5)	24000
D245 13	10	27	34	40	75	10	1+1 (3)	24000
D245 14	10	35	39	40	80	10	1+1 (4)	24000
D245 15	10	44	49	40	90	10	1+1 (5)	24000
D245 16	12	27	34	40	75	12	1+1 (3)	24000
D245 17	12	35	39	40	80	12	1+1 (4)	24000
D245 18	12	44	49	40	90	12	1+1 (5)	24000

Fresa in diamante Z1+1, placchetta in diamante economico H2,5 mm riaffilabile massimo 3 volte. Tre divisioni in elica, prima placchetta positiva, il resto negativo. Forante in diamante e corpo in widia.

Fresa de diamante Z1+1 con plaquita de diamante económico de 2,5 mm de altura (reafilable 3 veces, como máximo). Cuenta con tres secciones en cada hélice, la primera plaquita con ángulo de corte positivo y las demás negativo. Broca para taladrar de diamante y cuerpo en metal duro.

DP shank cutter Z1+1 with eco DP tips H2,5 mm resharpened up to 3 times three helicoidal wing, first tip positive all the others negative, plunge tip in HM, HM body.

Fraise diamant Z1+1, plaquette en diamant économique H2,5 mm réaffûttable maximum 3 fois. Trois divisions en hélice, première plaquette positive et le reste négatif. Perceur en diamant et corps en widia.

Nachschleifbarer Diamantfräser, mit wechselseitigem Achswinkel (2 positiv + 2 negativ), Schneiden zum Schruppen/Schlichten, PKD H 2,5, Körper aus Schwermetall HDM, geeignet zur Nesting-Bearbeitung von MDF-, HDF-, HPL-, Kohlenstofffaserplatten, Trespa und Corian.

Алмазная фреза Z1+1, пластина из дешёвого алмаза H2,5 мм. Заточка макс. 3 раза. 3 деления спирали, первая пластина положительная, остальные отрицательные. Сверло алмазное, корпус - твёрдосплав.



# Art. D239

## fresa in diamante con tagliente positivo negativo Z4 rompitruciolo con corpo in HDM metallo pesante DP H 3,5 mm

DP diamond router bit with positive+negative cut Z4, chip-breaker, high density metal body, H 3,5 mm

Diamantfräser mit wechselseitigem Achswinkel (positiv/negativ), Z4, Spanbrecher, Körper aus HDM DP H 3,5 mm

fresa de diamante con filo cortante alterno positivo/negativo Z4 rompevirutas y cuerpo en HDM DP H 3,5 mm

Fraise diamant avec plaquette alternée positif/négatif Z4 brises copeaux corps en HDM DP H 3,5 mm

Алмазная фреза, нож отрицательно-положительный Z4, стружколом с корпусом из HDM (тяжелый металл) DP H 3,5 mm

Section INDEX

INDEX by article

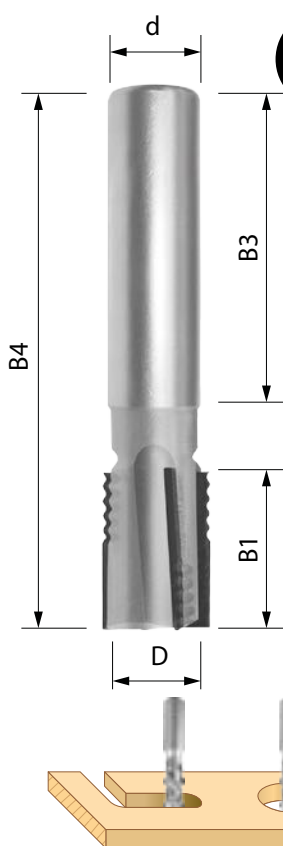

PRICE LIST

ANGOLO ASSIALE AXIAL ANGLE  
5°

POSITIV NEGATIV

3,5 mm.  
H

FORANTE / DRILL  
DP

CORPO / BODY  
HDM METALLO PESANTE

Cod.	D mm	B1 mm	B3 mm	B4 mm	d mm	Z tot	rpm max
D239 10	12	19	40	65	12	4	24000
D239 11	12	24	40	70	12	4	24000
D239 12	12	24	50	80	12	4	24000
D239 13	12	28	40	75	12	4	24000

Fresa in diamante riaffilabile a taglienti interi, angolo assiale alternato (2 positivi - 2 negativi), taglienti sgrossatori - finitori, altezza DP 3,5 mm, corpo in metallo pesante HDM, adatta per lavorazioni di nesting su pannelli di MDF, HDF, HPL, pannelli fibra di carbonio, trespa e corian.

Re-sharpening shank cutter with full tips, cutting angle (2 positive - 2 negative), rough/finishing cutting tips DP 3,5 mm, HDM body, tool suitable for nesting operation on MDF, HDF, HPL, panels also in carbon fibre, trespa and corian.

Nachschleifbarer Diamantfräser, mit wechselseitigem Achswinkel (2 positiv + 2 negativ), Schneiden zum Schruppen/Schlichten, PKD H 3,5, Körper aus Schwermetall HDM, geeignet zur Nesting-Bearbeitung von MDF-, HDF-, HPL-, Kohlenstofffaserplatten, Trespa und Corian.

Fresa de diamante reafilable con filos cortantes para desbaste y acabado, ángulos axiales alternos (2 filos cortantes positivos + 2 filos cortantes negativos), plaquita en DP de 3,5 mm de altura y cuerpo de metal pesado HDM. Es ideal para trabajos de nesting en paneles de MDF, HDF, HPL, paneles de fibra de carbono, placas Trespa y Corian.

Fraise en diamant réaffûtable, angle axial alterné (2 positifs + 2 négatifs), plaquettes pour ébauche, et pour finition, hauteur DP 3,5 mm, corps en métal lourd HDM, adapté pour l'usinage nesting sur des matériaux tels que MDF, HDF, HPL, panneaux en fibre de carbone, trespa et corian

Алмазная заточиваемая фреза с цельными ножами, с осевым переменным углом: 2 положительных и 2 отрицательных. Грубые ножи высотой DP 3,5 mm, корпус из тяжёлого металла HDM, соответствует nesting обработкам панелей MDF, HDF, HPL, панелей из углеродного волокна, треспы и кориана.

# Art. D213

## fresa in diamante elicoidale Z1+1 con corpo in acciaio DP H 4,5 mm

DP diamond helical router bit Z1+1, steel body, H 4.5 mm

Diamant-Spiralfräser Z1+1 mit Körper aus Stahl, PKD H 4,5 mm

fresa de diamante helicoidal Z1+1 con cuerpo en acero y plaquita en DP de H 4,5 mm

Fraise diamant hélicoïdale Z1+1 corps en HW DP H 4,5 mm

Алмазная спиральная фреза Z1+1 корпус из стали DP H 4,5 mm

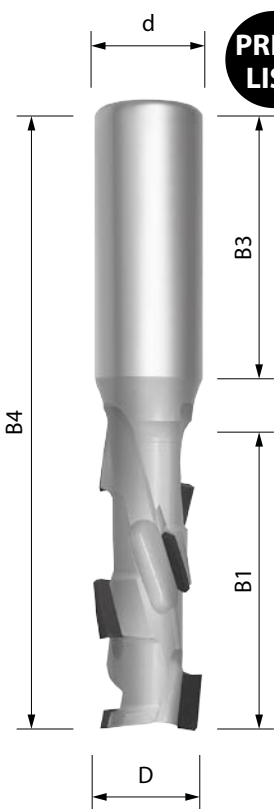

PRICE LIST

ANGOLO ASSIALE AXIAL ANGLE  
20°

+ NEGATIV

4,5 mm.  
H

FORANTE / DRILL  
HW

Cod.	D mm	B1 mm	B3 mm	B4 mm	d mm	Z tot	rpm max
D213 10	20	27	50	85	20	1+1 (3)	24000
D213 11	20	35	50	95	20	1+1 (4)	24000
D213 12	20	43	50	103	20	1+1 (5)	24000
D213 13	20	52	50	112	20	1+1 (6)	24000
D213 14	20	61	50	121	20	1+1 (7)	24000
D213 15	20	70	50	130	20	1+1 (8)	24000

Fresa in diamante Z1+1, placchetta in diamante H4,5 mm (riaffilabile 8 volte), 3 divisioni in elica, prima placchetta positiva, il resto negative. Forante in widia e corpo in acciaio. Ottima per lavorazione di pannelli in truciolare rivestito, laminati, MDF rivestito e legni duri senza nodi.

DP shank cutter Z1+1 with eco DP tips H4,5 mm resharpened up to 8 times three helicoidal wing, first tip positive all the others negative, plunge tip in HM steel body. Suitable for working on chipboard panels, plywood, laminated, solid wood and MDF.

Diamantfräser Z1+1, Schneide aus Diamant H 4,5 mm (8 Mal nachschleifbar), 3 Schneidereihen, die erste Schneide positiv, die anderen negativ. Einbohrschneide aus Widia und Körper aus Stahl. Ideal zur Bearbeitung von beschichteten Spanplatten, Laminat, beschichtetem MDF und Hartholz ohne Knoten.

Fresa de diamante Z1+1 con plaquita de diamante de 4,5 mm de altura (reafilable 8 veces), tres secciones en cada hélice, la primera plaquita con ángulo de corte positivo y las demás negativo. Broca para taladrar de metal duro y cuerpo en acero. Es ideal para mecanizar paneles de aglomerado revestido, laminados, MDF revestido y maderas duras sin nudos.

Fraise en diamant Z1+1, plaquette diamant H4,5 mm (réaffûtable 8 fois), 3 divisions en hélice, première plaquette positive et le reste négatif. Perceur en vidia et corps en acier. Optimale pour l'usinage de panneau agglomérés revêtus, laminés, MDF revêtu et bois durs sans nœuds.

Алмазная фреза Z1+1, пластина из алмаза H4,5 мм (Заточка 8 раз), 3 деления спирали, первая пластина положительная, остальные отрицательные. Сверло алмазное, корпус — сталь. Отличная для обработки ДСП с покрытием, МДФ, ламината, древесины твёрдых пород без сучков.



Section INDEX

DP diamond helical router bit Z1+1, steel body, H 2.5 mm

Diamant-Spiralfräser Z1+1 mit Körper aus Stahl, PKD H 2,5 mm

fresa de diamante helicoidal Z1+1 con cuerpo en acero y plaquita en DP de H 2,5 mm

Fraise diamant hélicoïdale Z1+1 corps en acier DP H 2,5 mm

Алмазная спиральная фреза Z1+1 корпус из стали DP H 2,5 mm

INDEX by article

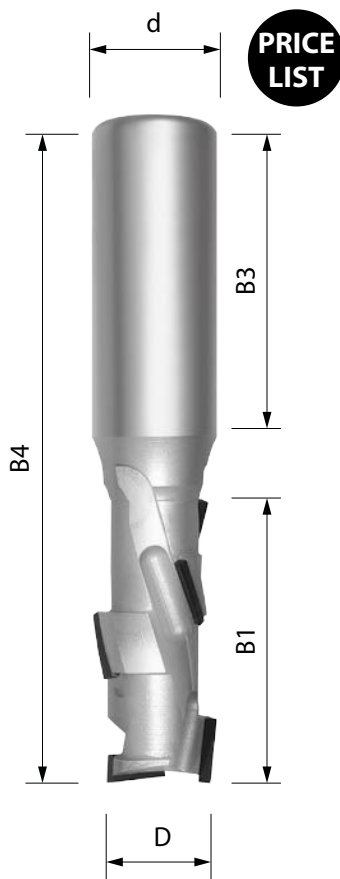

ANGOLO ASSIALE AXIAL ANGLE  
**10°/25°**

+ NEGATIV

2,5 mm.  
H

FORANTE / DRILL  
HW

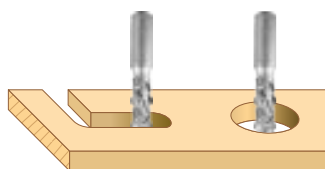

Cod.	D mm	B1 mm	B3 mm	B4 mm	d mm	Z tot	rpm max
D212 10	10	27	40	75	10	1+1 (3)	24000
D212 11	10	27	40	75	12	1+1 (3)	24000
D212 12	12	27	40	75	12	1+1 (3)	24000
D212 13	12	34	40	84	12	1+1 (4)	24000
D212 14	12	43	40	93	12	1+1 (5)	24000
D212 15	16	27	50	85	16	1+1 (3)	24000
D212 16	16	27	50	85	20	1+1 (3)	24000
D212 17	16	34	50	94	16	1+1 (4)	24000
D212 18	16	34	50	94	20	1+1 (4)	24000
D212 19	16	43	50	103	16	1+1 (5)	24000
D212 20	16	43	50	103	20	1+1 (5)	24000
D212 21	18	27	50	85	20	1+1 (3)	24000
D212 22	18	34	50	94	20	1+1 (4)	24000
D212 23	18	43	50	103	20	1+1 (5)	24000
D212 24	20	27	50	85	20	1+1 (3)	24000
D212 25	20	35	50	95	20	1+1 (4)	24000
D212 26	20	43	50	103	20	1+1 (5)	24000
D212 27	20	52	50	112	20	1+1 (6)	24000
D212 28	20	61	50	121	20	1+1 (7)	24000
D212 29	20	70	50	130	20	1+1 (8)	24000
D212 30	25	34	55	99	25	1+1 (4)	24000
D212 31	25	43	55	108	25	1+1 (5)	24000
D212 32	25	52	55	117	25	1+1 (6)	24000
D212 33	25	61	55	126	25	1+1 (7)	24000
D212 34	25	76	55	126	25	1+1 (9)	24000
D212 35	25	87	55	126	25	1+1 (10)	24000
D212 36	25	95	55	126	25	1+1 (1)	24000
D212 37	25	105	55	126	25	1+1 (12)	24000
D212 38	25	113	55	126	25	1+1 (13)	24000

Fresa in diamante Z1+1, placchetta in diamante economico H2,5 mm (riaffilabile massimo 3 volte), 3 divisioni in elica, prima placchetta positiva, il resto negative. Forante in widia e corpo in acciaio.

DP shank cutter Z1+1 with eco DP tips H2,5 mm resharpened up to 3 times three helicoidal wing, first tip positive all the others negative, plunge tip in HM, steel body.

Diamantfräser Z1+1, Schneide aus preiswertem Diamant H 2,5 mm (max. 3 Mal nachschleifbar), 3 Schneidereien, die erste Schneide positiv, die anderen negativ. Einbohrschneide aus Widia und Körper aus Stahl.

Fresa de diamante Z1+1 con plaquita de diamante económico de 2,5 mm de altura (reafilable 3 veces, como máximo), tres secciones en cada hélice, la primera plaquita con ángulo de corte positivo y las demás negativo. Broca para taladrar de metal duro y cuerpo en acero.

Fraise en diamant Z1+1, plaquette en diamant économique H2,5 mm (réaffûtable maximum 3 fois), 3 divisions en hélice, première plaquette positive et le reste négatif. Perceur en vidia et corps en acier.

Алмазная фреза Z1+1, пластина из дешевого алмаза H2,5 мм. Заточка макс. 3 раза. 3 деления спирали, первая пластина положительная, остальные отрицательные. Сверло алмазное, корпус - сталь.

DP diamond helical router bit Z2+2, steel body, H 2.5 mm

Diamant-Spiralfräser Z2+2 mit Körper aus Stahl, PKD H 2,5 mm

fresa de diamante helicoidal Z2+2 con cuerpo en acero y plaquita en DP de H 2,5 mm

Fraise diamant hélicoïdale Z2+2 corps en acier DP H 2,5 mm

Алмазная спиральная фреза Z2+2 корпус из стали DP H 2,5 mm

Section INDEX

INDEX by article

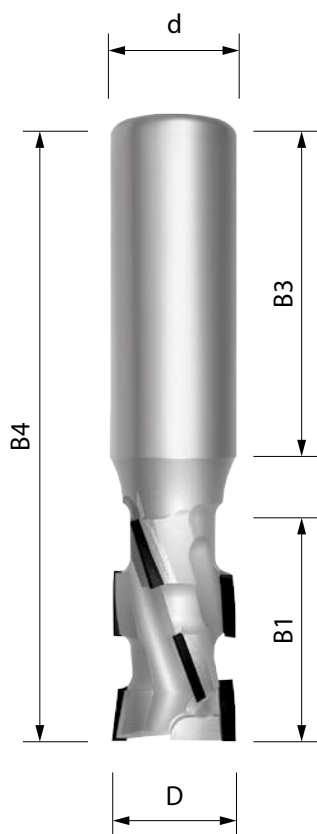

ANGOLO ASSIALE AXIAL ANGLE  
**10°/20°**

+ NEGATIV

2,5 mm.

FORANTE / DRILL  
HW

PRICE LIST

Cod.	D mm	B1 mm	B3 mm	B4 mm	d mm	Z tot	rpm max
D215 10	12	27	40	75	12	2+2 (6)	24000
D215 11	12	34	40	84	12	2+2 (8)	24000
D215 12	16	27	50	85	16	2+2 (6)	24000
D215 13	16	27	50	85	20	2+2 (6)	24000
D215 14	16	34	50	94	16	2+2 (8)	24000
D215 15	16	34	50	94	20	2+2 (8)	24000
D215 16	18	27	50	85	20	2+2 (6)	24000
D215 17	18	34	50	94	20	2+2 (8)	24000
D215 18	18	43	50	103	20	2+2 (10)	24000
D215 19	20	27	50	85	20	2+2 (6)	24000
D215 20	20	34	50	94	20	2+2 (8)	24000
D215 21	20	43	50	103	20	2+2 (10)	24000
D215 22	20	52	50	112	20	2+2 (12)	24000
D215 23	20	61	50	121	20	2+2 (14)	24000
D215 24	20	70	50	130	20	2+2 (16)	24000
D215 25	20	80	50	140	20	2+2 (18)	24000

Fresa in diamante Z2+2, con placchetta riaffilabile H2,5 mm, 4 divisioni in elica, prima placchetta positiva traente con il resto delle placchette negative. Forante in widia, angolo assiale di 20°+/--. Corpo in acciaio speciale

DP shank cutter Z2+2 with DP tips H2,5 mm, 4 helicoidal wing, first tip positive all the others negative, plunge tip in HM steel body cutting angle 20°. Suitable for working on chipboard panels, plywood, laminated, solid wood and MDF.

Diamantfräser Z2+2, mit nachschleifbarer Schneide H 2,5 mm, 4 Schneidereien, die erste ziehende Schneide positiv, die anderen negativ. Einbohrschneide aus Widia, Achswinkel 20°+/--. Körper aus Sonderstahl.

Fresa de diamante Z2+2 con plaquita reafilable de 2,5 mm de altura, cuatro secciones en cada hélice, la primera plaquita con ángulo de corte positivo y las demás negativo. Broca para taladrar en metal duro, ángulo axial de 20° +/--. Cuerpo en acero especial.

Fraise diamant Z2+2 avec plaquette réaffûtable H2,5, 4 divisions en hélice, première plaquette positive et le reste négatif. Perceur en vidia, angle axial de 20° +/--. Corps en acier spécial.

Алмазная фреза Z2+2 с заточиваемой пластиной H2,5 мм, 4 деления в сверле, первая пластина несущая - положительная, остальные отрицательные. Сверло из твердого сплава, осевой угол 20 ° +/--. Корпус из специальной стали.

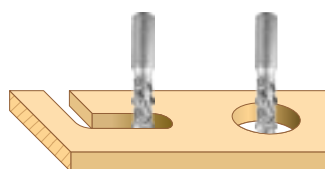

Section  
INDEX

DP diamond helical router bit Z2+2, steel body, H 4.5 mm

Diamant-Spiralfräser Z2+2 mit Körper aus Stahl, PKD H 4,5 mm

fresa de diamante helicoidal Z2+2 con cuerpo en acero y plaquita en DP de H 4,5 mm

Fraise en diamant hélicoïdale Z2+2 corps en acier DP H 4,5 mm

Алмазная спиральная фреза Z2+2 корпус из стали DP H 4,5 mm

INDEX  
by article

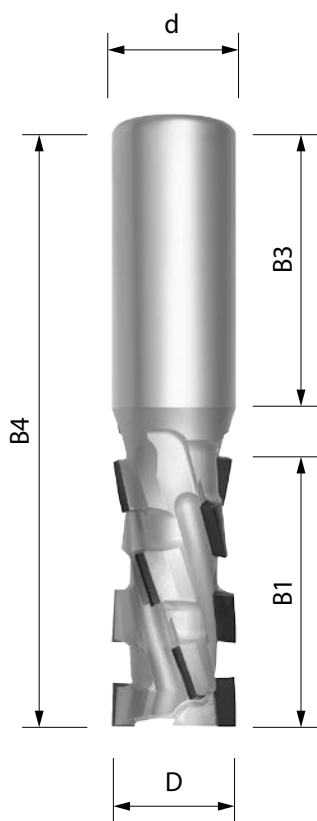

ANGOLO ASSIALE  
AXIAL ANGLE  
**20°**

+ NEGATIV

4,5 mm.

FORANTE / DRILL

PRICE  
LIST

Cod.	D mm	B1 mm	B3 mm	B4 mm	d mm	Z tot	rpm max
D216 10	20	27	50	85	20	2+2 (6)	24000
D216 11	20	34	50	95	20	2+2 (8)	24000
D216 12	20	43	50	103	20	2+2 (10)	24000
D216 13	20	52	50	112	20	2+2 (12)	24000
D216 14	20	61	50	121	20	2+2 (14)	24000
D216 15	20	70	50	130	20	2+2 (16)	24000
D216 16	25	75	55	135	25	2+2 (18)	24000
D216 17	25	87	55	135	25	2+2 (20)	24000
D216 18	25	105	55	135	25	2+2 (24)	24000
D216 19	25	112	55	135	25	2+2 (26)	24000

Fresa in diamante Z2+2, con placchetta H4,5 mm (max 8 riaffilature), 4 divisioni in elica, prima placchetta positiva con il resto delle placchette negative. Forante in widia, angolo assiale 20° +/- . Corpo fresa in acciaio speciale. Ottima per lavorazione di pannelli in truciolare rivestito, pannelli laminati, nobilitati, MDF rivestiti, multistrati rivestiti, legni duri senza nodi e materiali polimerici.

DP shank cutter Z2+2 with DP tips H4,5 mm resharpened up to 8 times four helicoidal wing, first tip positive all the others negative, plunge tip in HM steel body cutting angle 20°. Suitable for working on chipboard panels, plywood, laminated, solid wood, MDF and polymers.

Diamantfräser Z2+2, mit Schneide H 4,5 mm, 4 Schneidereien (max. 8 Mal nachschleifbar), die erste Schneide positiv, die anderen negativ. Einbohrschneide aus Widia, Achswinkel 20° +/- . Schneidkörper aus Sonderstahl. Ideal zur Bearbeitung von beschichteten Spanplatten, Laminat- oder veredelten Platten, beschichtetem MDF, beschichteten Mehrschichtplatten, Hartholz ohne Knoten und Polymerwerkstoffen.

Fresa de diamante Z2+2 con plaquita de 4,5 mm de altura (reafilable 8 veces, como máximo), cuatro secciones en cada hélice, la primera plaquita con ángulo de corte positivo y las demás negativo. Broca para taladrar en metal duro, ángulo axial de 20° +/- . Cuerpo en acero especial. Es ideal para mecanizar paneles laminados, de aglomerado revestido, melamina, MDF revestido, contrachapado revestido, maderas duras sin nudos y materiales poliméricos.

Fraise diamant Z2+2 avec plaquette H4,5 mm (réaffûtable maximum 8 fois), 4 divisions en hélice, première plaquette positive et le reste négatif. Perceur en widia, angle axial de 20° +/- . Corps en acier spécial. Optimale pour l'usinage de panneaux agglomérés revêtus, panneaux laminés, anoblis, MDF revêtu, multicouches revêtus, bois durs sans nœud et matériaux polymères.

Алмазная фреза Z2+2 с пластиной H4,5 мм (макс. 8 раз заточка), 4 спиральных деления, первая положительная пластина, остальные отрицательные. Сверло из твёрдого сплава, осевой угол 20° +/- . Корпус из специальной стали. Отлично подходит для обработки ДСП панелей с покрытием, ламинированных панелей, шпонированных панелей, МДФ с покрытием, многослойных панелей с покрытием, твёрдых пород дерева без сучков и полимерных материалов.

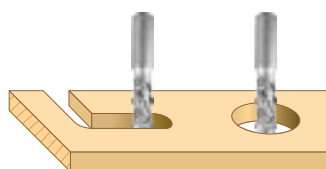

DP diamond helical router bit Z1+1 with copy bearing, steel body, H 2.5 mm

Diamant-Spiralfräser mit Lager Z1+1, Körper aus Stahl, PKD H 2,5 mm

fresa de diamante helicoidal con cojinete Z1+1, cuerpo en acero y plaquita en DP de H 2,5 mm

Fraise diamant hélicoïdale avec roulement Z1+1 corps en acier DP H 2,5 mm

Алмазная спиральная фреза с подшипником Z1+1 корпус из стали DP H 2,5 mm

Section INDEX

INDEX by article

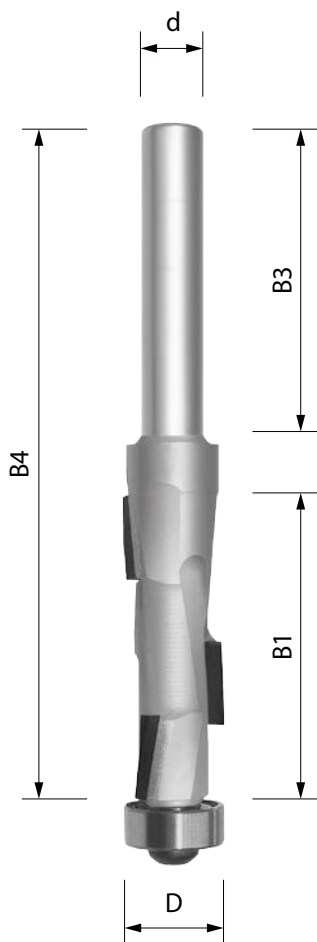

ANGOLO ASSIALE AXIAL ANGLE  
**20°**

+ NEGATIV

2,5 mm.  
H

PRICE LIST

Cod.	D mm	B1 mm	B3 mm	B4 mm	d mm	Z tot	rpm max
D214 10	12,7	27	40	81	8	1+1 (3)	24000
D214 11	12,7	27	40	81	12	1+1 (3)	24000
D214 12	12,7	34	40	90	8	1+1 (4)	24000
D214 13	12,7	34	40	90	12	1+1 (4)	24000
D214 14	12,7	43	40	99	12	1+1 (5)	24000
D214 15	24	27	51	80	12	1+1 (3)	24000
D214 16	24	35	51	88	12	1+1 (4)	24000
D214 17	24	43	40	99	12	1+1 (5)	24000

Fresa in diamante Z1+1 con cuscinetto di battuta, placchetta in diamante economico H2,5 mm (riaffilabile massimo 3 volte), 3 divisioni in elica, prima placchetta positiva, il resto delle placchette negative. Ottima per lavorazione di rifilatura e contornatura di pannelli in truciolare rivestito, pannelli laminati, MDF rivestito e legni duri senza nodi.

Fresa de diamante Z1+1 con cojinete de tope, plaquita de diamante económico de 2,5 mm de altura (reafilable 3 veces, como máximo), tres secciones en cada hélice, la primera plaquita con ángulo de corte positivo y las demás negativo. Es ideal para refilar y cantear paneles laminados, de aglomerado revestido, MDF revestido y maderas duras sin nudos.

DP shank cutter Z1+1 with copy bearing, eco DP tips H2,5 mm resharpened up to 3 times three helicoidal wing, first tip positive all the others negative. Suitable for working on chipboard panels, plywood, laminated, solid wood and MDF.

Fraise diamant Z1+1 avec roulement à billes, plaquette en diamant économique H2,5 (réaffûtable maximum 3 fois), 3 divisions en hélice, première plaquette positive et le reste négatif. Optimale pour affleurer et contourner des panneaux en agglomérés revêtus, laminés, MDF revêtu et bois durs sans nœuds.

Diamantfräser Z1+1 mit Anschlag, Schneide aus preiswertem Diamant H 2,5 mm (max. 3 Mal nachschleifbar), 3 Schneidereien, die erste Schneide positiv, die anderen negativ. Ideal zum Besäumen und Konturfräsen von beschichteten Spanplatten, Laminateplatten, beschichtetem MDF und Hartholz ohne Knoten.

Алмазная фреза Z1+1 с упорным подшипником, пластина из эконом алмаза H2,5 mm, заточка макс. 3 раза, 3 деления спирали, первая пластина положительная, остальные отрицательные. Отлично подходит для обрезки и обработки контуров панелей из ДСП с покрытием, ламинированных панелей, МДФ с покрытием и твёрдых пород дерева без сучков.

Section  
INDEX

DP diamond helical router bit Z2+2, steel body, H 2.5 mm

Diamant-Spiralfräser Z2+2 mit Körper aus Stahl, PKD H 2,5 mm

fresa de diamante helicoidal Z2+2 con cuerpo en acero y plaquita en DP de H 2,5 mm

Fraise diamant hélicoïdale Z2+2 corps en acier DP H 2,5 mm

Алмазная спиральная фреза Z2+2 корпус из стали DP H 2,5 mm

INDEX  
by article

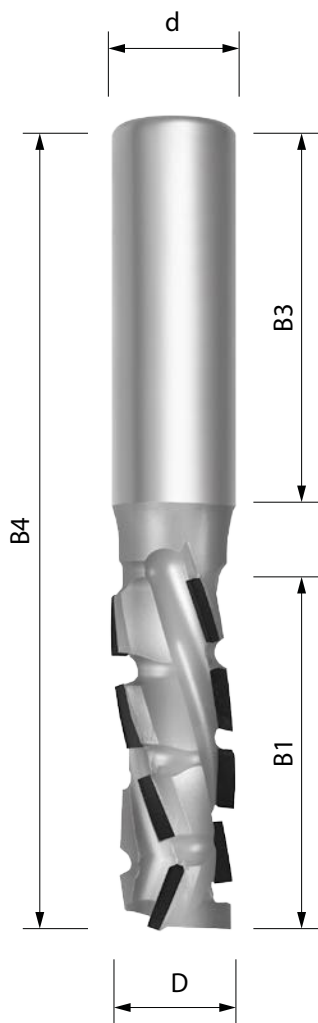

ANGOLO ASSIALE  
AXIAL ANGLE  
**20°**

+ NEGATIV

2,5 mm.  
H

FORANTE / DRILL  
HW

PRICE  
LIST

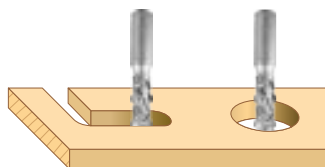

Cod.	D mm	B1 mm	B3 mm	B4 mm	d mm	Z tot	rpm max
D220 10	16	35	50	95	16	2+2 (9)	24000
D220 11	16	35	50	95	20	2+2 (9)	24000
D220 12	16	46	50	106	16	2+2 (12)	24000
D220 13	16	46	50	106	20	2+2 (12)	24000
D220 14	18	35	50	95	20	2+2 (9)	24000
D220 15	18	46	50	106	20	2+2 (12)	24000
D220 16	20	52	50	112	20	2+2 (14)	24000
D220 17	20	62	50	122	20	2+2 (16)	24000
D220 18	20	73	50	133	20	2+2 (18)	24000

Fresa in diamante Z2+2, con placchetta economica H2,5 mm (max 3 riaffilature), 3 divisioni in elica, prima placchetta positiva traente con il resto delle placchette negative. Forante in widia, angolo assiale 20° +/-, corpo in acciaio speciale. Ottima per lavorazione di pannelli in truciolare rivestito, pannelli laminati, nobilitati, MDF rivestiti, legni duri senza nodi e materiali polimerici.

DP shank cutter Z2+2 with eco DP tips H2,5 mm resharpened up to 3 times three helicoidal wing, first tip positive all the others negative, plunge tip in HM, cutting angle 20° steel body. Suitable for working on chipboard panels, laminated, solid wood, MDF and polymers.

Diamantfräser Z2+2, mit preiswerter Schneide H 2,5 mm (max. 3 Mal nachschleifbar), 3 Schneidereihen, die erste Schneide positiv, die anderen negativ. Einbohrschneide aus Widia, Achswinkel 20° +/-, Körper aus Sonderstahl. Ideal zur Bearbeitung von beschichteten Spanplatten, Laminat- oder veredelten Platten, beschichtetem MDF, Hartholz ohne Knoten und Polymerwerkstoffen.

Fresa de diamante Z2+2 con plaquita económica de 2,5 mm de altura (reafilable 3 veces, como máximo), tres secciones en cada hélice, la primera plaquita con ángulo de corte positivo y las demás negativo. Broca para taladrar en metal duro, ángulo axial de 20° +/- y cuerpo en acero especial. Es ideal para mecanizar paneles laminados, de aglomerado revestido, melamina, MDF revestido, maderas duras sin nudos y materiales poliméricos.

Fraise diamant Z2+2 avec plaquette économique H2,5 mm (réaffûtable maximum 3 fois), 3 divisions en hélice, première plaquette positive et le reste négatif. Perceur en vidia, angle axial de 20° +/- . Corps en acier spécial. Optimale pour l'usinage de panneaux agglomérés revêtus, panneaux laminés, anoblis, MDF revêtus, bois durs sans nœud et matériaux polymères

Алмазная фреза Z2+2 с эконом пластиной H2,5 mm (макс. 3 заточки), 3 деления спирали, первая пластина несущая положительная, остальные отрицательные. Отлично подходит для обработки ДСП панелей с покрытием, ламинированных панелей, шпонируемых панелей, МДФ с покрытием, мультислойных панелей с покрытием, твёрдых пород дерева без сучков и полимерных материалов.

DP diamond helical router bit Z2+2, steel body, H 4.5 mm

Diamant-Spiralfräser Z2+2 mit Körper aus Stahl, PKD H 4,5 mm

fresa de diamante helicoidal Z2+2 con cuerpo en acero y plaquita en DP de H 4,5 mm

Fraise diamant hélicoïdale Z2+2 corps en acier DP H 4,5 mm

Алмазная спиральная фреза Z2+2 корпус из стали DP H 4,5 mm

Section INDEX

INDEX by article

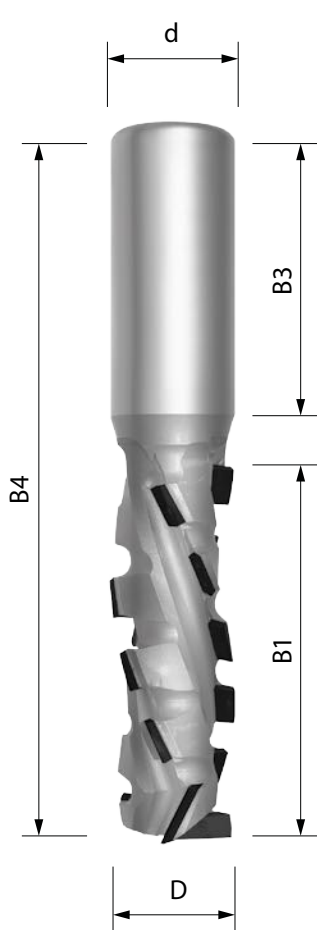

ANGOLO ASSIALE AXIAL ANGLE  
**20°**

+ NEGATIV

4,5 mm.  
H

FORANTE / DRILL  
DP

PRICE LIST

Cod.	D mm	B1 mm	B3 mm	B4 mm	d mm	Z tot	rpm max
D221 10	20	44	50	104	20	2+2 (10)	24000
D221 11	20	53	50	113	20	2+2 (12)	24000
D221 12	20	65	50	125	20	2+2 (15)	24000
D221 13	22	44	50	104	25	2+2 (10)	24000
D221 14	22	53	50	113	25	2+2 (12)	24000
D221 15	22	65	50	125	25	2+2 (15)	24000
D221 16	22	70	50	130	25	2+2 (17)	24000

Fresa in diamante Z2+2, con placchetta H4,5 mm (max 8 riaffilature), 3 divisioni in elica, prima placchetta positiva traente con il resto delle placchette negative. Forante in diamante, angolo assiale 20° +/- , corpo in acciaio speciale. Ottima per lavorazione di pannelli in truciolare rivestito, pannelli laminati, nobilitati, MDF rivestiti, legni duri senza nodi e materiali polimerici.

DP shank cutter Z2+2 with DP tips H4,5 mm resharpened up to 8 times three helicoidal wing, first tip positive all the others negative, plunge tip in DP, cutting angle 20° steel body. Suitable for working on chipboard panels, laminated, solid wood, MDF and polymers.

Diamantfräser Z2+2, mit Schneide H 4,5 mm (max. 8 Mal nachschleifbar), 3 Schneidereihen, die erste ziehende Schneide positiv, die anderen negativ. Einbohrschneide aus Diamant, Achswinkel 20° +/- , Körper aus Sonderstahl. Ideal zur Bearbeitung von beschichteten Spanplatten, Laminat- oder veredelten Platten, beschichtetem MDF, Hartholz ohne Knoten und Polymerwerkstoffen.

Fresa de diamante Z2+2 con plaquita de 4,5 mm de altura (reaffilable 8 veces, como máximo), tres secciones en cada hélice, la primera plaquita con ángulo de corte positivo y las demás negativo. Broca para taladrar en diamante, ángulo axial de 20° +/- y cuerpo en acero especial. Es ideal para mecanizar paneles laminados, de aglomerado revestido, melamina, MDF revestido, maderas duras sin nudos y materiales poliméricos.

Fraise diamant Z2+2 avec plaquette H4,5 mm (réaffûtable maximum 8 fois), 3 divisions en hélice, première plaquette positive et le reste négatif. Perceur en diamant, angle axial de 20° +/- . Corps en acier spécial. Optimale pour l'usinage de panneaux agglomérés revêtus, panneaux laminés, anoblis, MDF revêtus, bois durs sans nœud et matériaux polymères.

Алмазная фреза Z2+2 с пластиной H4,5 mm (макс. 8 раз заточка), 3 деления спирали, первая пластина несущая положительная, остальные отрицательные. Отлично подходит для обработки ДСП панелей с покрытием, ламинированных панелей, шпонируемых панелей, МДФ с покрытием, мультислойных панелей с покрытием, твёрдых пород дерева без сучков и полимерных материалов.

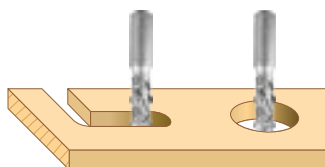

Section  
INDEX

DP diamond helical router bit Z3+3, steel body, H 4.5 mm

Diamant-Spiralfräser Z3+3 mit Körper aus Stahl, PKD H 4,5 mm

fresa de diamante helicoidal Z3+3 con cuerpo en acero y plaquita en DP de H 4,5 mm

Fraise en diamant hélicoïdale Z3+3 corps en acier DP H 4,5 mm

Алмазная спиральная фреза Z3+3 корпус из стали DP H 4,5 mm

INDEX  
by article

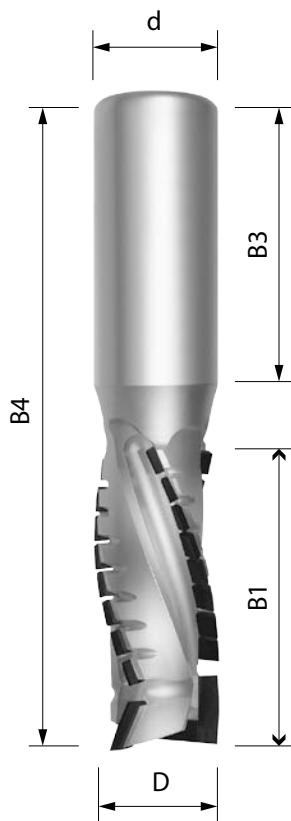

ANGOLO ASSIALE  
AXIAL ANGLE

20°/25°

+ NEGATIV

4,5 mm.

FORANTE / DRILL

HW

PRICE  
LIST

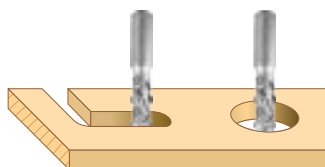

Cod.	D mm	B1 mm	B3 mm	B4 mm	d mm	Z tot	rpm max
D224 10	18	25	50	85	20	3+3 (11)	24000
D224 11	18	30	50	90	20	3+3 (14)	24000
D224 12	20	25	50	85	20	3+3 (11)	24000
D224 13	20	30	50	90	20	3+3 (14)	24000
D224 14	20	35	50	95	20	3+3 (17)	24000
D224 15	20	45	50	105	20	3+3 (23)	24000
D224 16	20	55	50	125	20	3+3 (29)	24000
D224 17	22	35	50	95	20	3+3 (17)	24000
D224 18	22	45	50	105	20	3+3 (23)	24000
D224 19	22	52	50	112	20	3+3 (29)	24000
D224 20	22	60	50	120	20	3+3 (32)	24000
D224 21	25	30	55	95	25	3+3 (14)	24000
D224 22	25	45	55	110	25	3+3 (23)	24000
D224 23	25	50	55	115	25	3+3 (26)	24000
D224 24	25	55	55	115	25	3+3 (29)	24000
D224 25	25	60	55	125	25	3+3 (32)	24000
D224 26	25	70	55	135	25	3+3 (34)	24000

Fresa in diamante Z3+3, con placchetta riaffilabile H4,5 mm (max 8 riaffilature), 3 divisioni in elica, prima placchetta positiva traente con il resto delle placchette negative. Forante in diamante, angolo assiale da 20° +/- . Corpo in acciaio speciale. Ottima per lavorazione di pannelli in truciolare rivestito, MDF rivestito, laminati, nobilitati e legni duri senza nodi.

DP shank cutter Z3+3 with DP tips H4,5 mm resharpened up to 8 times three helicoidal wing, first tip positive all the others negative, plunge tip in DP, cutting angle 20° +/- . Suitable for working on chipboard panels, laminated, solid wood and MDF.

Diamantfräser Z3+3, mit Schneide H 4,5 mm (max. 8 Mal nachschleifbar), 3 Schneidreihen, die erste ziehende Schneide positiv, die anderen negativ. Einbohrschneide aus Diamant, Achswinkel 20° +/- . Körper aus Sonderstahl. Ideal zur Bearbeitung von beschichteten Spanplatten, beschichtetem MDF, Laminat, veredelten Platten und Hartholz ohne Knoten.

Fresa de diamante Z3+3 con plaquita de 4,5 mm de altura (reafilable 8 veces, como máximo), tres secciones en cada hélice, la primera plaquita con ángulo de corte positivo y las demás negativo. Broca para taladrar en diamante, ángulo axial de 20° +/- . Cuerpo en acero especial. Es ideal para mecanizar paneles laminados, de aglomerado revestido, melamina, MDF revestido y maderas duras sin nudos.

Fraise diamant Z3+3 avec plaquette H4,5 mm (réaffûtable maximum 8 fois), 3 divisions en hélice, première plaquette positive et le reste négatif. Perceur en diamant, angle axial de 20° +/- . Corps en acier spécial. Optimale pour l'usinage de panneaux agglomérés revêtus, MDF revêtu, anoblis et bois durs sans nœud.

Алмазная фреза Z3+3 с пластиной H4,5 мм (макс. 8 раз заточка), 3 спиральных деления, первая пластина несущая положительная, остальные отрицательные. Сверло из твердого сплава, осевой угол 20 ° +/- Корпус из специальной стали. Отлично подходит для обработки ДСП панелей, МДФ шпонированных панелей, ламината, твёрдых пород дерева без сучков.

DP diamond helical router bit Z3+3, steel body, H 4.5 mm

Diamant-Spiralfräser Z3+3 mit Körper aus Stahl, PKD H 4,5 mm

fresa de diamante helicoidal Z3+3 con cuerpo en acero y plaquita en DP de H 4,5 mm

Fraise diamant hélicoïdale Z3+3 corps en acier DP H 4,5 mm

Алмазная спиральная фреза Z3+3 корпус из стали DP H 4,5 mm

Section INDEX

INDEX by article

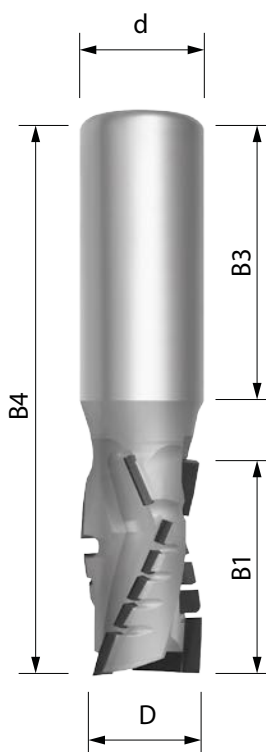

ANGOLO ASSIALE AXIAL ANGLE  
**20°/25°**

+ POSITIV

4,5 mm.  
H

FORANTE / DRILL  
DP

PRICE LIST

Cod.	D mm	B1 mm	B3 mm	B4 mm	d mm	Z tot	rpm max
D225 10	20	25	50	85	20	3+3 (9)	24000
D225 11	20	30	50	90	20	3+3 (12)	24000
D225 12	20	35	50	95	20	3+3 (15)	24000
D225 13	20	45	50	105	20	3+3 (25)	24000
D225 14	22	35	50	95	20	3+3 (15)	24000
D225 15	22	45	50	105	20	3+3 (21)	24000
D225 16	22	50	50	110	20	3+3 (26)	24000
D225 17	22	55	50	115	20	3+3 (29)	24000
D225 18	22	60	50	120	20	3+3 (32)	24000
D225 19	25	30	55	95	25	3+3 (12)	24000
D225 20	25	45	55	110	25	3+3 (21)	24000
D225 21	25	50	55	115	25	3+3 (24)	24000
D225 22	25	55	55	120	25	3+3 (27)	24000
D225 23	25	60	55	125	25	3+3 (32)	24000

Fresa in diamante Z3+3, con placchetta riaffilabile H4,5 mm (max 8 riaffilature), 3 divisioni in elica, assialità della fresa prevalentemente positiva per un'ottima estrazione del truciolo verso l'attacco. Forante in diamante, angolo assiale da 20° +/- . Corpo in acciaio speciale. Ottima per lavorazione di pannelli in truciolare rivestito, MDF rivestito.

Fresa de diamante Z3+3 con plaquita de 4,5 mm de altura (reafilable 8 veces, como máximo) y tres secciones en cada hélice. Los ángulos axiales de la fresa son casi todo positivos para facilitar la extracción de la viruta hacia el acoplamiento. Broca para taladrar en diamante, ángulo axial de 20° +/- . Cuerpo en acero especial. Es ideal para mecanizar paneles de aglomerado revestido y MDF revestido.

DP shank cutter Z3+3 with DP tips H4,5 mm resharpened up to 8 times three helicoidal wing, tip mainly positive for better evacuation of wooden chips, plunge tip in DP, cutting angle 20° steel body. Suitable for working on chipboard panels, laminated and MDF.

Fraise en diamant Z3+3, avec plaquette réaffûtable H.4,5 mm (réaffûtable maximum 8 fois) 3 divisions en hélice, axialité de la fraise principalement positive pour une extraction optimale du copeaux vers la coupe. Perceur en diamant, angle axial de 20° +/- . Corps en acier spécial. Optimale pour l'usinage de panneaux en aggloméré, MDF revêtus.

Diamantfräser Z3+3, mit Schneide H 4,5 mm (max. 8 Mal nachschleifbar), 3 Schneidereihen, vorwiegend positiver Achswinkel des Fräasers für eine optimale Spanabfuhr zum Schaft. Einbohrschneide aus Diamant, Achswinkel 20° +/- . Körper aus Sonderstahl. Ideal zur Bearbeitung von beschichteten Spanplatten, beschichtetem MDF.

Алмазная фреза Z3+3 с пластиной H4,5 мм (макс. 8 раз заточка), 3 спиральных деления. Осевая сила фрезы в основном, положительная и способствует извлечению стружки в сторону патрона. Сверло из алмаза, осевой угол 20° +/- . Корпус из специальной стали. Отлично подходит для обработки панелей ДСП, МДФ со шпоном или покрытием.

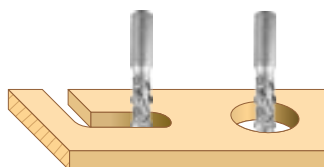



Section INDEX

DP diamond helical router bit Z2+2, steel body, H 4.5 mm

Diamant-Spiralfräser Z2+2 mit Körper aus Stahl, PKD H 4,5 mm

fresa de diamante helicoidal Z2+2 con cuerpo en acero y plaquita en DP de H 4,5 mm

Fraise en diamant hélicoïdale Z2+2 avec corps en acier DP H 4,5 mm

Алмазная спиральная фреза Z2+2 корпус из стали DP H 4,5 mm

INDEX by article

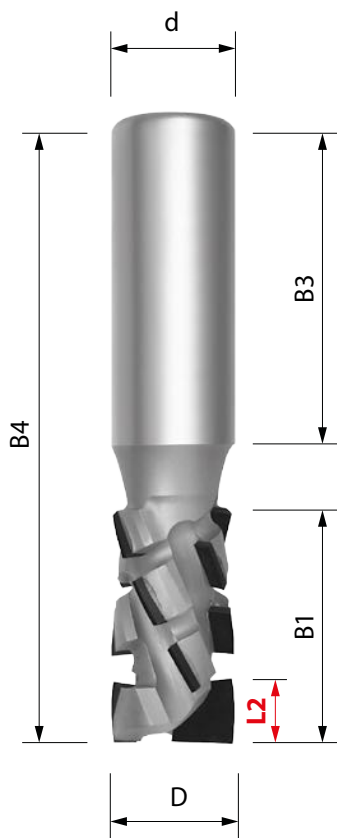

ANGOLO ASSIALE AXIAL ANGLE  
**30°**

+ NEGATIV

4,5 mm.  
H

FORANTE / DRILL  
DP

PRICE LIST

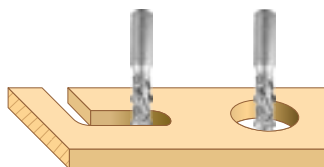

Cod.	D mm	B1 mm	B3 mm	B4 mm	d mm	L2 mm	Z tot	rpm max
D228 10	16	26	50	85	16	11	2+2 (9)	24000
D228 11	16	31	50	91	16	11	2+2 (11)	24000
D228 12	16	36	50	96	16	11	2+2 (13)	24000
D228 13	18	26	50	85	20	11	2+2 (9)	24000
D228 14	20	26	50	85	20	11	2+2 (9)	24000
D228 15	20	31	50	91	20	11	2+2 (11)	24000
D228 16	20	36	50	96	20	11	2+2 (13)	24000
D228 17	20	43	50	101	20	11	2+2 (15)	24000
D228 18	20	47	50	107	20	11	2+2 (17)	24000
D228 19	20	52	50	112	20	11	2+2 (19)	24000
D228 20	20	63	50	123	20	11	2+2 (23)	24000
D228 21	22	26	50	85	20	11	2+2 (9)	24000
D228 22	22	36	50	96	20	11	2+2 (13)	24000
D228 23	22	43	50	101	20	11	2+2 (15)	24000
D228 24	22	47	50	107	20	11	2+2 (17)	24000
D228 25	22	57	50	117	20	11	2+2 (21)	24000
D228 26	22	52	50	112	22	11	2+2 (19)	24000
D228 27	22	63	50	123	22	11	2+2 (23)	24000
D228 28	25	43	55	106	25	11	2+2 (15)	24000
D228 29	25	47	55	112	25	11	2+2 (17)	24000
D228 30	25	52	55	117	25	11	2+2 (19)	24000
D228 31	25	57	55	122	25	11	2+2 (21)	24000
D228 32	25	63	55	128	25	11	2+2 (23)	24000
D228 33	25	68	55	133	25	11	2+2 (25)	24000
D228 34	25	72	55	133	25	11	2+2 (27)	24000
D228 35	25	84	55	133	25	11	2+2 (31)	24000

Fresa in diamante Z2+2, con placchetta ri-affilabile h4,5mm (max 8 riaffilature), 4 divisioni in elica, prima placchetta positiva traente con il resto delle placchette negative. Forante in diamante, corpo in acciaio speciale, angolo assiale da 30° per ottenere ottime finiture sul pannello. Ottima per lavorazione di pannelli in truciolare rivestito, MDF rivestito, multistrato rivestito, legni duri senza nodi.

DP shank cutter Z2+2 with DP tips H4,5 mm resharpened up to 8 times four helicoidal wing, first tip positive all the others negative, plunge tip in DP, cutting angle 30° steel body. Suitable for working on chipboard panels, plywood, laminated, solid wood and MDF.

Diamantfräser Z2+2, mit Schneide H4,5 mm (max. 8 Mal nachschleifbar), 4 Schneidereien, die erste ziehende Schneide positiv, die anderen negativ. Einbohrschneide aus Diamant, Körper aus Sonderstahl, Achswinkel 30° für eine hervorragende Oberflächengüte der Platten. Ideal zur Bearbeitung von beschichteten Spanplatten, beschichtetem MDF, beschichteten Mehrschichtplatten und Hartholz ohne Knoten.

Fresa de diamante Z2+2 con plaquita de 4,5 mm de altura (reafilable 8 veces, como máximo), cuatro secciones en cada hélice, la primera plaquita con ángulo de corte positivo y las demás negativo. Broca para taladrar en diamante, cuerpo en acero especial y ángulo axial de 30° para obtener un excelente acabado del panel. Es ideal para mecanizar paneles de aglomerado revestido, MDF revestido, contrachapado revestido y maderas duras sin nudos.

Fraise en diamant Z2+2 avec plaquettes réaffûttables H4,5 mm (maximum 8 réaffûtage), 4 divisions en hélice, première plaquette positive qui entraine le reste des plaquettes négatives. Perceur en diamant, corps en acier spécial, angle axial de 30° pour obtenir des finitions optimales sur panneaux. Optimale pour l'usinage de panneaux en aggloméré revêtus, MDF revêtus, multicouches revêtues, bois durs sans nœud.

Алмазная фреза Z2+2 с пластиной H4,5 мм (макс. 8 раз заточка), 4 спиральных деления, первая пластина несущая положительная, остальные отрицательные. Сверло из алмаза, корпус из специальной стали, осевой угол 30 ° +/- что позволяет получить отличную обработку панели. Отлично подходит для обработки ДСП панелей, МДФ шпонированных панелей, многослойных панелей с покрытием, твёрдых пород дерева без сучков.

DP diamond helical router bit Z2+2, steel body, H 4.5 mm

Diamant-Spiralfräser Z2+2 mit Körper aus Stahl, PKD H 4,5 mm

fresa de diamante helicoidal Z2+2 con cuerpo en acero y plaquita en DP de H 4,5 mm

Fraise en diamant hélicoïdale Z2+2 avec corps en acier DP H 4,5 mm

Алмазная спиральная фреза Z2+2 корпус из стали DP H 4,5 mm

Section INDEX

INDEX by article

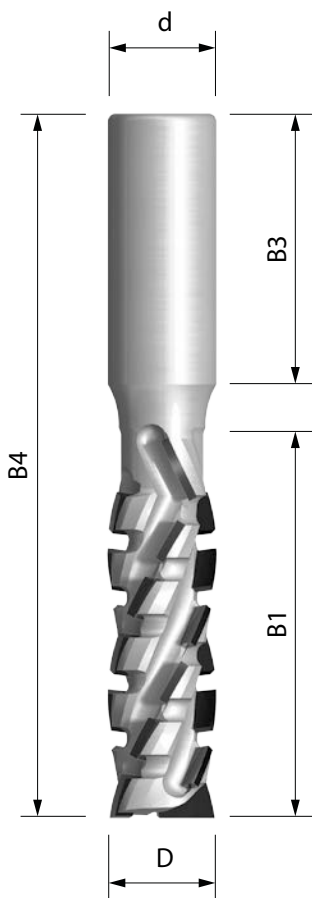

ANGOLO ASSIALE AXIAL ANGLE  
**30°**

+ POSITIV

4,5 mm. H

FORANTE / DRILL  
**DP**

PRICE LIST

Cod.	D mm	B1 mm	B3 mm	B4 mm	d mm	Z tot	rpm max
D229 10	20	25	50	85	20	2+2 (9)	24000
D229 11	20	31	50	91	20	2+2 (11)	24000
D229 12	20	36	50	96	20	2+2 (13)	24000
D229 13	20	41	50	101	20	2+2 (15)	24000
D229 14	20	47	50	107	20	2+2 (17)	24000
D229 15	20	52	50	112	20	2+2 (19)	24000
D229 16	20	57	50	127	20	2+2 (23)	24000
D229 17	20	68	50	138	20	2+2 (25)	24000
D229 18	22	25	50	85	20	2+2 (9)	24000
D229 19	22	36	50	96	20	2+2 (13)	24000
D229 20	22	47	50	107	20	2+2 (17)	24000
D229 21	22	52	50	112	20	2+2 (19)	24000
D229 22	22	57	50	127	20	2+2 (23)	24000
D229 23	22	68	50	138	20	2+2 (25)	24000
D229 24	25	36	55	101	25	2+2 (13)	24000
D229 25	25	41	55	106	25	2+2 (15)	24000
D229 26	25	47	55	112	25	2+2 (17)	24000
D229 27	25	52	55	117	25	2+2 (19)	24000
D229 28	25	57	55	122	25	2+2 (19)	24000
D229 29	25	63	55	128	25	2+2 (23)	24000
D229 30	25	68	55	133	25	2+2 (25)	24000

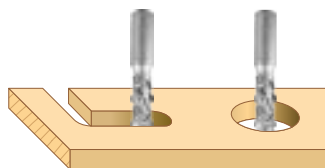

Fresa in diamante Z2+2, con placchetta riafilabile H4,5 mm (max 8 riaffilature), 4 divisioni in elica, assilità dei taglianti prevalentemente positiva per favorire l'estrazione de truciolo verso l'attacco. Forante in diamante, corpo in acciaio speciale, angolo assiale da 30° per ottenere ottime finiture sul pannello. Ottima per lavorazione di pannelli in truciolare rivestito, MDF rivestito, multistrato rivestito e legni duri senza nodi.

DP shank cutter Z2+2 with DP tips H4,5 mm resharpened up to 8 times four helicoidal wing, tip mainly positive for better evaquaton of wood-en chips, plunge tip in DP, cutting angle 30° steel body. Suitable for working on chipboard panels, plywood, laminated, solid wood and MDF.

Diamantfräser Z2+2, mit Schneide H 4,5 mm (max. 8 Mal nachschleifbar), 4 Schneidereien, vorwiegend positiver Achswinkel der Schneiden fördert die Spanabfuhr zum Schaft. Einbohrschneide aus Diamant, Körper aus Sonderstahl, Achswinkel 30° für eine hervorragende Oberflächengüte der Platten. Ideal zur Bearbeitung von beschichteten Spanplatten, beschichtetem MDF, beschichteten Mehrschichtplatten und Hartholz ohne Knoten.

Fresa de diamante Z2+2 con plaquita de 4,5 mm de altura (reafilable 8 veces, como máximo) y cuatro secciones en cada hélice. Los ángulos axiales de los filos cortantes son casi todo positivos para facilitar la extracción de la viruta hacia el acoplamiento. Broca para taladrar en diamante, cuerpo en acero especial y ángulo axial de 30° para obtener un excelente acabado del panel. Es ideal para mecanizar paneles de aglomerado revestido, MDF revestido, contrachapado revestido y maderas duras sin nudos.

Fraise en diamant Z2+2 avec plaquette réaffûtable H4,5 mm (max. 8 réaffûtages), 4 divisions en hélice, axialité des coupes principalement positive pour favoriser l'extraction des copeaux vers le haut. Perceur en diamant, corps en acier spécial, angle axial de 30° pour obtenir des finitions optimales sur les panneaux. Optimales pour l'usinage de panneaux en aggloméré revêtues, MDF revêtu, multicouches revêtues et bois durs sans nœud.

Алмазная фреза Z2+2 с пластиной H4,5 мм (макс. 8 раз заточка), 4 спиральных делений, осевая сила фрезы в основном, положительная и способствует извлечению стружки в сторону патрона. Сверло из алмаза, корпус из специальной стали, осевой угол 30° +/- что позволяет получить отличную обработку панели. Отлично подходит для обработки ДСП панелей с покрытием, МДФ шпонируемых панелей, многослойных панелей с покрытием, твердых пород дерева без сучков.

Section INDEX

DP diamond helical router bit Z3+3, steel body, H 4.5 mm

Diamant-Spiralfräser Z3+3 mit Körper aus Stahl, PKD H 4,5 mm

fresa de diamante helicoidal Z3+3 con cuerpo en acero y plaquita en DP de H 4,5 mm

Fraise en diamant hélicoïdale Z3+3 avec corps en acier DP H 4,5 mm

Алмазная спиральная фреза Z3+3 корпус из стали DP H 4,5 mm

INDEX by article

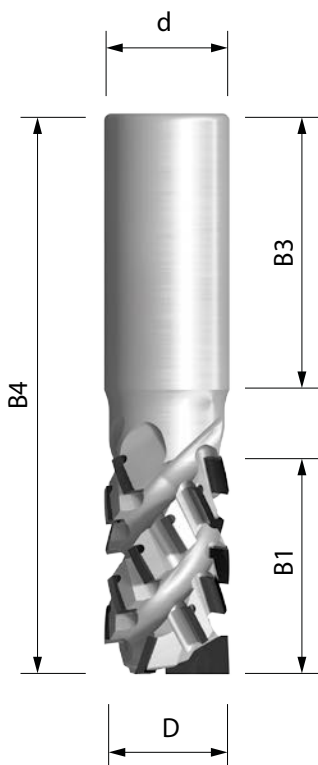

ANGOLO ASSIALE AXIAL ANGLE

30°

+ NEGATIV

4,5 mm.

FORANTE / DRILL

DP

PRICE LIST

Cod.	D mm	B1 mm	B3 mm	B4 mm	d mm	Z tot	rpm max
D230 10	25	25	55	94	25	3+3 (12)	24000
D230 11	25	31	55	100	25	3+3 (15)	24000
D230 12	25	37	55	106	25	3+3 (18)	24000
D230 13	25	43	55	112	25	3+3 (21)	24000
D230 14	25	49	55	118	25	3+3 (24)	24000
D230 15	25	55	55	124	25	3+3 (27)	24000
D230 16	25	61	55	130	25	3+3 (30)	24000
D230 17	25	67	55	135	25	3+3 (33)	24000
D230 18	25	73	55	142	25	3+3 (36)	24000
D230 19	25	78	55	147	25	3+3 (39)	24000
D230 20	25	84	55	154	25	3+3 (42)	24000

Fresa in diamante Z3+3, con placchetta riaffilabile H4,5 mm (max 8 riaffilature), 6 divisioni in elica, prima placchetta positiva traente con il resto delle placchette negative. Forante in diamante, corpo in acciaio speciale, angolo assiale da 30° per ottenere ottime finiture sul pannello. Ottima per lavorazione di pannelli in trucolare rivestito, MDF rivestito, multistrato rivestito e legni duri senza nodi.

DP shank cutter Z3+3 with DP tips H4,5 mm resharpened up to 8 times four helicoidal wing, first tip positive all the others negative, plunge tip in DP, cutting angle 30° steel body. Suitable for working on chipboard panels, plywood, laminated, solid wood and MDF.

Diamantfräser Z3+3, mit Schneide H 4,5 mm (max. 8 Mal nachschleifbar), 6 Schneidereien, die erste ziehende Schneide positiv, die anderen negativ. Einbohrschneide aus Diamant, Körper aus Sonderstahl, Achswinkel 30° für eine hervorragende Oberflächengüte der Platten. Ideal zur Bearbeitung von beschichteten Spanplatten, beschichtetem MDF, beschichteten Mehrschichtplatten und Hartholz ohne Knoten.

Fresa de diamante Z3+3 con plaquita de 4,5 mm de altura (reafilable 8 veces, como máximo), seis secciones en cada hélice, la primera plaquita con ángulo de corte positivo y las demás negativo. Broca para taladrar en diamante, cuerpo en acero especial y ángulo axial de 30° para obtener un excelente acabado del panel. Es ideal para mecanizar paneles de aglomerado revestido, MDF revestido, contrachapado revestido y maderas duras sin nudos.

Fraise en diamant Z3+3 avec plaquette réaffilable H4,5 mm (max 8 réaffutages), 6 divisions en hélice, première plaquette positive qui entraîne le reste des plaquettes négatives. Perceur en diamant, corps en acier spécial, angle axial de 30° pour obtenir des finitions optimales sur panneaux. Optimale pour l'usinage de panneaux en aggloméré revêtus, MDF revêtus, multicouches revêtus et bois durs sans nœud.

Алмазная фреза Z3+3 с пластиной H4,5 мм (макс. 8 раз заточка), 6 спиральных делений. Первая пластина несущая положительная, остальные отрицательные. Сверло из алмаза, корпус из специальной стали, осевой угол 30° +/- что позволяет получить отличную обработку панели. Отлично подходит для обработки ДСП панелей с покрытием, МДФ шпонированных панелей, многослойных панелей с покрытием, твёрдых пород дерева без сучков.

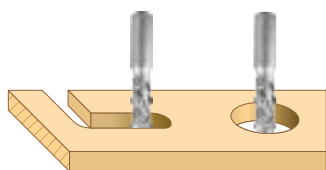

DP diamond helical router bit Z2+2, SYMMETRICAL, steel body, H 4.5 mm

SYMMETRISCHER Diamant-Spiralfräser Z2+2 mit Körper aus Stahl, PKD H 4,5 mm

fresa de diamante helicoidal SIMÉTRICA Z2+2 con cuerpo en acero y plaquita en DP de H 4,5 mm

Fraise en diamant hélicoïdales SYMMÉTRIQUE Z2+2 avec corps en acier DP H 4,5 mm

Алмазная спиральная симметричная фреза Z2+2 корпус из стали DP H 4,5 mm

Section INDEX

INDEX by article

**NEW**

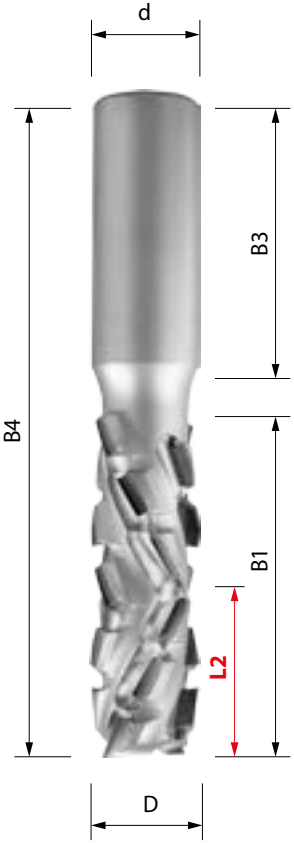

ANGOLO ASSIALE AXIAL ANGLE  
**30°**

SYMMETRIC

4,5 mm.  
H

FORANTE / DRILL  
DP

PRICE LIST

Cod.	D mm	B1 mm	B3 mm	B4 mm	d mm	L2 mm	Z tot	rpm max
D232 10	20	34	50	94	20	18	13+1	24000
D232 11	20	44	50	104	20	23	17+1	24000
D232 12	20	54	50	114	20	28	21+1	24000
D232 13	20	64	50	123	20	30	23+1	24000
D232 14	20	74	50	134	20	37	28+1	24000
D232 15	25	64	50	129	25	33	24+1	24000
D232 16	25	74	50	139	25	38	29+1	24000
D232 17	25	84	50	149	25	43	33+1	24000

Fresa in diamante Z2+2, con placchetta riaffilabile H4,5 mm (max 8 riaffilature), 8 divisioni in elica, assialità confluyente al centro, angolo assiale da 20° per ottenere ottime finiture sul pannello. Ideale per lavorazione di bordatura di pannelli in truciolare rivestito, MDF rivestito e multistrato rivestito.

DP rectifying shank cutter Z2+2 with DP tips H4,5 mm resharpened up to 8 times, eight helicoidal wing, cutting angle 20°. Suitable for working on laminated chipboard panels, laminated MDF and laminated plywood.

Diamantfräser Z2+2, mit Schneide H 4,5 mm (max. 8 Mal nachschleifbar), 8 Schneidereien, mittig ausgerichtet, Achswinkel 20° für eine hervorragende Oberflächengüte der Platte. Ideal zum Besäumen von beschichteten Spanplatten, beschichtetem MDF und Mehrschichtplatten.

Fresa de diamante Z2+2 con plaquita de 4,5 mm de altura (reafilable 8 veces, como máximo), ocho secciones en cada hélice, axialidad confluyente en el centro y ángulo axial de 20° para

Fraise en diamant Z2+2 avec plaquettes réaffûtables H 4,5 mm (max 8 réaffûtages), 8 divisions en hélice, axialité confluyente au centre, angle axial de 20° pour obtenir une finition optimale sur le panneau, idéale pour l'usinage de chant de panneaux en aggloméré revêtu, MDF revêtu et multicouche revêtu

Алмазная фреза Z2+2 с заточиваемыми пластинами H 4,5 mm (максм. 8 заточек), 8 делений на спирали, ось по центру, осевой угол 20° что позволяет получить отличную обработку панели. Идеально подходит для обработки кромки шпонированных ДСП, MDF и мультислойных панелей.

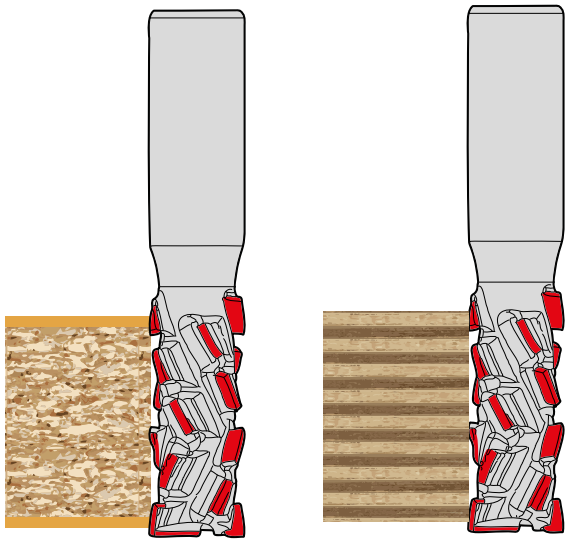
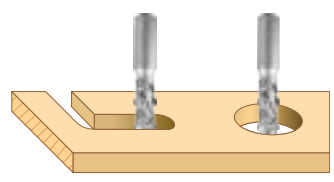

**Disposizione simmetrica**  
**Symmetric tip arrangement**

Section INDEX

DP diamond helical router bit Z2+2, steel body, H 4.5 mm

Diamant-Spiralfräser Z2+2 mit Körper aus Stahl, PKD H 4,5 mm

fresa de diamante helicoidal Z2+2 con cuerpo en acero y plaquita en DP de H 4,5 mm

Fraise en diamant hélicoïdale Z2+2 avec corps en acier DP H 4,5 mm

Алмазная спиральная фреза Z2+2 корпус из стали DP H 4,5 mm

INDEX by article

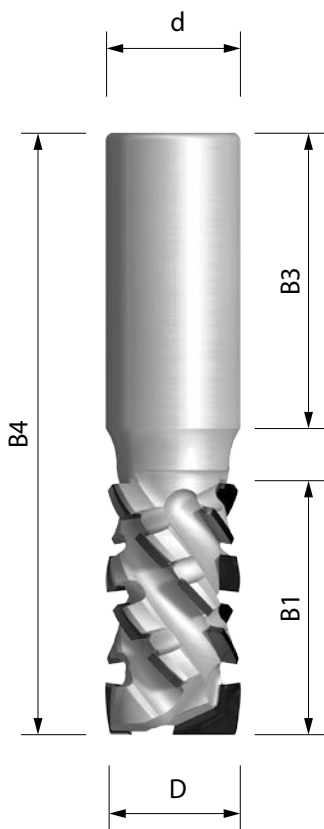

ANGOLO ASSIALE AXIAL ANGLE

45°

+ NEGATIV

4,5 mm.

FORANTE / DRILL

DP

PRICE LIST

Cod.	D mm	B1 mm	B3 mm	B4 mm	d mm	Z tot	rpm max
D233 10	20	26	50	86	20	2+2 (11)	24000
D233 11	20	35	50	95	20	2+2 (15)	24000
D233 12	20	44	50	104	20	2+2 (19)	24000
D233 13	20	52	50	112	20	2+2 (23)	24000
D233 14	20	60	50	120	20	2+2 (27)	24000
D233 15	22	26	50	86	20	2+2 (11)	24000
D233 16	22	35	50	95	20	2+2 (15)	24000
D233 17	22	44	50	104	20	2+2 (19)	24000
D233 18	22	53	50	113	20	2+2 (23)	24000
D233 19	22	60	50	120	20	2+2 (27)	24000
D233 20	25	26	55	91	25	2+2 (11)	24000
D233 21	25	35	55	100	25	2+2 (15)	24000
D233 22	25	44	55	109	25	2+2 (19)	24000
D233 23	25	53	55	118	25	2+2 (23)	24000
D233 24	25	62	55	127	25	2+2 (27)	24000
D233 25	25	71	55	136	25	2+2 (31)	24000

Fresa in diamante Z2+2, con placchetta riaffilabile H4,5 mm (max 8 riaffilature), 4 divisioni in elica, prima placchetta positiva traente con il resto delle placchette negative. Forante in diamante, corpo in acciaio speciale, angolo assiale da 45° per ottenere ottime finiture sul pannello. Ottima per lavorazione di pannelli in truciolare rivestito, MDF rivestito, multistrato rivestito e legni duri senza nodi.

Fresa de diamante Z2+2 con plaquita de 4,5 mm de altura (reafilable 8 veces, como máximo), cuatro secciones en cada hélice, la primera plaquita con ángulo de corte positivo y las demás negativo. Broca para taladrar en diamante, cuerpo en acero especial y ángulo axial de 45° para obtener un excelente acabado del panel. Es ideal para mecanizar paneles de aglomerado revestido, MDF revestido, contrachapado revestido y maderas duras sin nudos.

DP shank cutter Z2+2 with DP tips H4,5 mm resharpened up to 8 times four helicoidal wing, first tip positive all the others negative, plunge tip in DP, cutting angle 45° steel body. Suitable for working on chipboard panels, plywood, laminated, solid wood and MDF.

Fraise en diamant Z2+2 avec plaquette réaffilable H4,5 mm (max 8 réaffutages), 4 divisions en hélice, première plaquette positive qui entraîne le reste des plaquettes négatives. Perceur en diamant, corps en acier spécial, angle axial de 30° pour obtenir des finitions optimales sur panneaux. Optimale pour l'usinage de panneaux en aggloméré revêtus, MDF revêtus, multicouches revêtus et bois durs sans nœud.

Diamantfräser Z2+2, mit Schneide H 4,5 mm (max. 8 Mal nachschleifbar), 4 Schneidereien, die erste ziehende Schneide positiv, die anderen negativ. Einbohrschneide aus Diamant, Körper aus Sonderstahl, Achswinkel 45° für eine hervorragende Oberflächengüte der Platten. Ideal zur Bearbeitung von beschichteten Spanplatten, beschichtetem MDF, beschichteten Mehrschichtplatten und Hartholz ohne Knoten.

Алмазная фреза Z2+2 с пластиной H4,5 мм (макс. 8 раз заточка), 4 спиральных деления, первая пластина несущая положительная, остальные отрицательные. Сверло из алмаза, корпус из специальной стали, осевой угол 45° что позволяет получить отличную обработку панели. Отлично подходит для обработки панелей с покрытием из ДСП, МДФ шпонированных панелей, многослойных панелей с покрытием, твёрдых пород дерева без сучков.

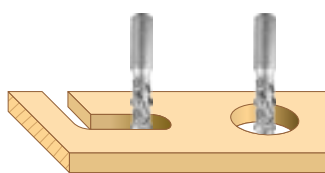

DP diamond helical router bit Z2+2, steel body, H 4.5 mm

Diamant-Spiralfräser Z2+2 mit Körper aus Stahl, PKD H 4,5 mm

fresa de diamante helicoidal Z2+2 con cuerpo en acero y plaquita en DP de H 4,5 mm

Fraise en diamant hélicoïdale Z2+2 avec corps en acier DP H 4,5 mm

Алмазная спиральная фреза Z2+2 корпус из стали DP H 4,5 mm

Section INDEX

INDEX by article

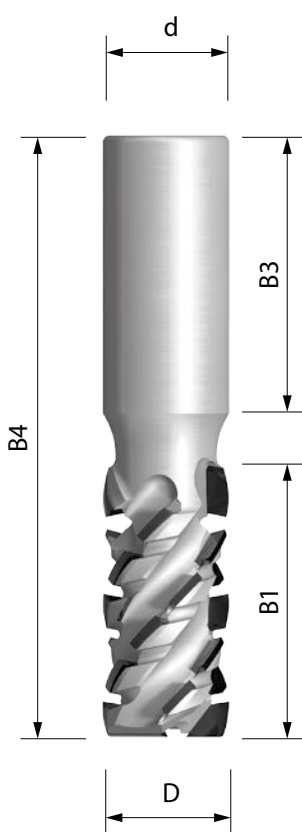

ANGOLO ASSIALE AXIAL ANGLE  
**45°**

+ POSITIV

4,5 mm.  
H

FORANTE / DRILL  
DP

PRICE LIST

Cod.	D mm	B1 mm	B3 mm	B4 mm	d mm	Z tot	rpm max
D234 10	20	17	50	77	20	2+2 (7)	24000
D234 11	20	17	55	82	25	2+2 (7)	24000
D234 12	20	26	50	86	20	2+2 (11)	24000
D234 13	20	26	55	91	25	2+2 (11)	24000
D234 14	20	35	50	95	20	2+2 (15)	24000
D234 15	20	35	55	100	25	2+2 (15)	24000
D234 16	20	44	50	104	20	2+2 (19)	24000
D234 17	20	44	55	109	25	2+2 (19)	24000
D234 18	20	52	50	112	20	2+2 (23)	24000
D234 19	20	52	55	117	25	2+2 (23)	24000
D234 20	20	60	50	120	20	2+2 (27)	24000
D234 21	20	60	55	125	25	2+2 (27)	24000
D234 22	22	17	50	77	20	2+2 (7)	24000
D234 23	22	17	55	82	25	2+2 (7)	24000
D234 24	22	26	50	86	20	2+2 (11)	24000
D234 25	22	26	55	91	25	2+2 (11)	24000
D234 26	22	35	50	95	20	2+2 (15)	24000
D234 27	22	35	55	100	25	2+2 (15)	24000
D234 28	22	44	50	104	20	2+2 (19)	24000
D234 29	22	44	55	109	25	2+2 (19)	24000
D234 30	22	53	50	113	20	2+2 (23)	24000
D234 31	22	53	55	118	25	2+2 (23)	24000
D234 32	22	60	50	120	20	2+2 (27)	24000
D234 33	22	60	55	125	25	2+2 (27)	24000
D234 34	25	17	55	82	25	2+2 (7)	24000
D234 35	25	26	55	91	25	2+2 (11)	24000
D234 36	25	35	55	100	25	2+2 (15)	24000
D234 37	25	44	55	109	25	2+2 (19)	24000
D234 38	25	53	55	118	25	2+2 (23)	24000
D234 39	25	62	55	127	25	2+2 (27)	24000
D234 40	25	71	55	136	25	2+2 (31)	24000
D234 41	25	80	55	145	25	2+2 (35)	24000

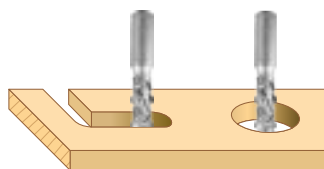

**IT** Fresa in diamante Z2+2, con placchetta ri-affilabile H4,5mm (max 8 riaffilature), 4 divisioni in elica, assilità dei taglianti prevalentemente positiva per favorire l'estrazione del truciolo verso l'attacco. Forante in diamante, corpo in acciaio speciale, angolo assiale da 45° per ottenere ottime finiture sul pannello. Ottima per lavorazione di pannelli in truciolare rivestito, MDF rivestito, multistrato rivestito, legni duri senza nodi.

**GB** DP shank cutter Z2+2 with DP tips H4,5 mm resharpened up to 8 times four helicoidal wing, tip mainly positive for better evaquaton of wood-en chips, plunge tip in DP, cutting angle 30° steel body. Suitable for working on chipboard panels, plywood, laminated, solid wood and MDF.

**DE** Diamantfräser Z2+2, mit Schneide H4,5 mm (max. 8 Mal nachschleifbar), 4 Schneidereien, vorwiegend positiver Achswinkel der Schneiden fördert die Spanabfuhr zum Schaft. Einbohrschneide aus Diamant, Körper aus Sonderstahl, Achswinkel 45° für eine hervorragende Oberflächengüte der Platten. Ideal zur Bearbeitung von beschichteten Spanplatten, beschichtetem MDF, beschichteten Mehrschichtplatten und Hartholz ohne Knoten.

**ES** Fresa de diamante Z2+2 con plaquita de 4,5 mm de altura (reafilable 8 veces, como máximo) y cuatro secciones en cada hélice. Los ángulos axiales de los filos cortantes son casi todo positivos para facilitar la extracción de la viruta hacia el acoplamiento. Broca para taladrar en diamante, cuerpo en acero especial y ángulo axial de 45° para obtener un excelente acabado del panel. Es ideal para mecanizar paneles de aglomerado revestido, MDF revestido, contrachapado revestido y maderas duras sin nudos.

**FR** Fraise en diamant Z2+2 avec plaquette réaffûtable H4,5 mm (max 8 réaffutages), 4 divisions en hélice, axialité des plaquettes principalement positive pour favoriser l'extraction des copeaux vers le haut. Perceur en diamant, corps en acier spécial, angle axial de 45° pour obtenir des finitions optimales sur panneaux. Optimale pour l'usinage de panneaux en aggloméré revêtus, MDF revêtus, multicouches revêtues, bois durs sans nœud.

**RU** Алмазная фреза Z2+2 с пластиной H4,5 мм (макс. 8 раз заточка), 4 спиральных делений. Первая пластина несущая положительная, остальные отрицательные. Сверло из алмаза, корпус из специальной стали, осевой угол 45° что позволяет получить отличную обработку панели. Отлично подходит для обработки ДСП панелей с покрытием, МФ шпонируемых панелей, мультислойных панелей с покрытием, твёрдых пород дерева без сучков.

Section INDEX

DP diamond helical router bit Z2+2, steel body, H 4.5 mm

Diamant-Spiralfräser Z2+2, Körper aus Stahl, PKD H 4,5 mm

fresa de diamante helicoidal Z2+2 con cuerpo en acero y plaquita en DP de H 4,5 mm

Fraise en diamant hélicoïdale Z2+2 avec corps en acier DP H 4,5 mm

Алмазная спиральная фреза Z2+2 корпус из стали DP H 4,5 mm

INDEX by article

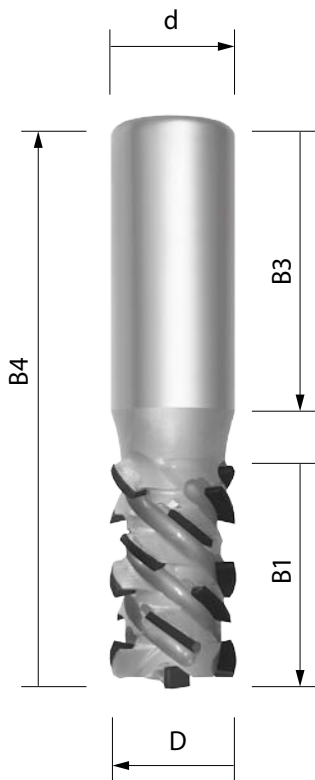

ANGOLO ASSIALE AXIAL ANGLE  
**54,9°**

+ NEGATIV

4,5 mm.  
H

FORANTE / DRILL  
DP

PRICE LIST

Cod.	D mm	B1 mm	B3 mm	B4 mm	d mm	Z tot	rpm max
D236 10	20	25	50	90	20	2+2 (11)	24000
D236 11	20	30	50	95	20	2+2 (13)	24000
D236 12	20	35	50	100	20	2+2 (15)	24000
D236 13	20	40	50	105	20	2+2 (17)	24000
D236 14	20	45	50	110	20	2+2 (19)	24000
D236 15	20	55	50	115	20	2+2 (23)	24000
D236 16	20	60	50	120	20	2+2 (25)	24000
D236 17	22	25	50	90	20	2+2 (11)	24000
D236 18	22	30	50	95	20	2+2 (13)	24000
D236 19	22	35	50	100	20	2+2 (15)	24000
D236 20	22	40	50	105	20	2+2 (17)	24000
D236 21	22	45	50	110	20	2+2 (19)	24000
D236 22	22	55	50	115	20	2+2 (23)	24000
D236 23	22	60	50	120	20	2+2 (25)	24000
D236 24	25	25	55	95	25	2+2 (11)	24000
D236 25	25	30	55	100	25	2+2 (13)	24000
D236 26	25	35	55	105	25	2+2 (15)	24000
D236 27	25	40	55	110	25	2+2 (17)	24000
D236 28	25	45	55	115	25	2+2 (19)	24000
D236 29	25	50	55	120	25	2+2 (21)	24000
D236 30	25	55	55	125	25	2+2 (23)	24000
D236 31	25	60	55	130	25	2+2 (25)	24000
D236 32	25	65	55	135	25	2+2 (27)	24000
D236 33	25	70	55	140	25	2+2 (29)	24000
D236 34	25	80	55	150	25	2+2 (33)	24000

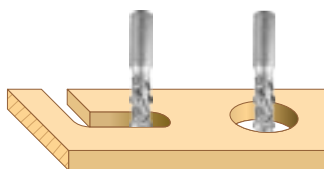

Fresa in diamante Z2+2 mm, con placchetta riaffilabile H4,5 mm (max 8 riaffilature), 4 divisioni in elica, prima placchetta positiva traente con il resto delle placchette negative. Forante in diamante, corpo in acciaio speciale, angolo assiale da 54,9° per ottenere ottime finiture sul pannello. Ottima per lavorazione di pannelli con rivestimento in carta, superfici verniciate, legni duri senza nodi lungo e controvena, truciolare rivestito, MDF rivestito e multistrato rivestito.

DP shank cutter Z2+2 mm with DP tips H4,5 mm resharpened up to 8 times four helicoidal wing, first tip positive all the others negative, plunge tip in DP, cutting angle 54,9° steel body. Suitable for working high-performance jointing and sizing of solid woods (free of knots) along and across the grain, jointing of melamine, paper, HPL laminated, foiled and veneered panels and lacquered surfaces, on chipboard, plywood, laminated and MDF.

Diamantfräser Z2+2 mm, mit Schneide H 4,5 mm (max. 8 Mal nachschleifbar), 4 Schneidereihen, die erste ziehende Schneide positiv, die anderen negativ. Einbohrschneide aus Diamant, Körper aus Sonderstahl, Achswinkel 54,9° für eine hervorragende Oberflächengüte der Platten. Ideal zur Bearbeitung von papierbeschichteten Spanplatten, lackierten Oberflächen, Hartholz ohne Knoten (in Längsrichtung und gegen die Maserung), beschichtetem MDF, beschichteten Mehrschichtplatten.

Fresa de diamante Z2+2 con plaquita de 4,5 mm de altura (reafileable 8 veces, como máximo), cuatro secciones en cada hélice, la primera plaquita con ángulo de corte positivo y las demás negativas. Broca para taladrar en diamante, cuerpo en acero especial y ángulo axial de 54,9° para obtener un excelente acabado del panel. Es ideal para mecanizar paneles con revestimiento de papel, superficies pintadas, maderas duras sin nudos a lo largo de las vetas y contravetas, paneles de aglomerado revestido, MDF revestido y contrachapado revestido.

Fraise en diamant Z2+2 avec plaquette réaffûtable H4,5 mm (max 8 réaffûtages), 4 divisions en hélice, première plaquette positive qui entraîne le reste des plaquettes négatives. Perceur en diamant, corps en acier spécial, angle axial de 54,9° pour obtenir des finitions optimales sur panneaux. Optimale pour l'usinage de panneaux revêtus de papier, surfaces vernies, bois durs sans nœuds le long en en travers du bois, aggloméré revêtu, MDF revêtus et multicouches revêtues.

Алмазная фреза Z2+2 с пластиной H4,5 мм (макс. 8 раз заточка), 4 спиральных делений. Первая пластина несущая положительная, остальные отрицательные. Сверло из алмаза, корпус из специальной стали, осевой угол 54,9° что позволяет получить отличную обработку панели. Отлично обрабатывает панели с бумажным покрытием, окрашенные поверхности, твёрдые породы дерева без сучков вдоль и против прожилки, ДСП с покрытием, МДФ с покрытием и мультислойные панели с покрытием.

DP diamond helical router bit Z2+2, high density metal body, H 3.5 mm

Diamant-Spiralfräser Z2+2, Körper aus Schwermetall HDM, PKD H 3,5 mm

fresa de diamante helicoidal Z2+2 con cuerpo en metal pesado HDM y plaquita en DP de H 3,5 mm

Fraise en diamant Z2+2 avec corps en HDM métal lourd DP H 3,5 mm

Алмазная спиральная фреза Z2+2 корпус из HDM (тяжелый металл) DP H 3,5 mm

Section INDEX

INDEX by article

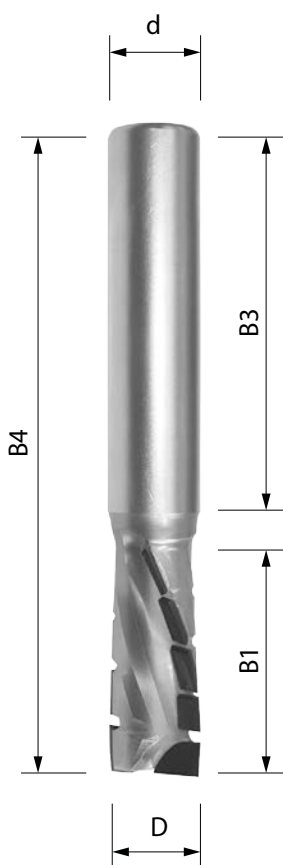

NESTING

ANGOLO ASSIALE AXIAL ANGLE

25°

+ NEGATIV

3,5 mm.

FORANTE / DRILL

DP

CORPO / BODY

HDM METALLO PESANTE

PRICE LIST

Cod.	D mm	B1 mm	B3 mm	B4 mm	d mm	Z tot	rpm max
D240 10	10	18	40	64	12	2+2 (6)	24000
D240 11	10	28	40	74	12	2+2 (9)	24000
D240 12	12	18	40	64	12	2+2 (6)	24000
D240 13	12	25	40	71	12	2+2 (8)	24000
D240 14	12	28	40	74	12	2+2(9)	24000
D240 15	12	35	40	81	12	2+2 (11)	24000

Fresa in diamante Z2+2, corpo fresa in HDM (metallo pesante) e acciaio. Ottima per lavorazione di pannelli in truciolare rivestito, MDF rivestito, multistrato rivestito, legni duri senza nodi. Ideale per lavorazione nesting, angolo assiale 25°, 2 eliche, DP H3,5 mm. Consigliata per lavorazione del multistrato grazie all'elevato canale di scarico del truciolero.

DP shank cutter Z2+2 for nesting, with DP tips H3,5 mm resharpened up to 3 times, two helical wing, first tip positive all the others negative, plunge tip in DP, cutting angle 25°, HDM (High density metal) and steel body.

Diamantfräser Z2+2, Schneidkörper aus HDM (Schwermetall) und Stahl. Ideal zur Bearbeitung von beschichteten Spanplatten, beschichtetem MDF, beschichteten Mehrschichtplatten und Hartholz ohne Knoten. Ideal für Nesting-Bearbeitungen, Achswinkel 25°, 2 Schneidreihen, PKD H 3,5 mm. Empfohlen zur Bearbeitung von Mehrschichtplatten, ermöglicht eine optimale Spanabfuhr.

Fresa de diamante Z2+2 con cuerpo en HDM (metal pesado) y acero. Es ideal para mecanizar paneles de aglomerado revestido, MDF revestido, contrachapado revestido y maderas duras sin nudos. Es adecuada para operaciones de nesting y dispone de ángulo axial de 25°, 2 hélices y plaquitas en DP de 3,5 mm de altura. Se aconseja su utilizo para mecanizar paneles de contrachapado en cuanto dispone de un gran canal de descarga de la viruta.

Fraise en diamant Z2+2, corps de fraise en HDM (métal lourd) et acier. Optimale pour l'usinage de panneaux agglomérés revêtus, MDF revêtus, multicouches revêtues, bois durs sans nœud, idéale pour l'usinage nesting, angle axial 25,2, 2 hélices, DP H.3,5. Conseillée pour l'usinage des multicouches grâce à un écoulement élevé du copeau.

Алмазная фреза Z2+2, корпус HDM (тяжёлый металл) и сталь. Отлично обрабатывает ДСП панели с покрытием, МДФ с покрытием и многослойные панели с покрытием, твёрдые породы дерева без сучков. Идеальная для nesting обработок, осевой угол 25°, 2 спирали, DP H3,5 mm. Рекомендуется для применения при обработке многослойных панелей, благодаря глубокому каналу выброса стружки.

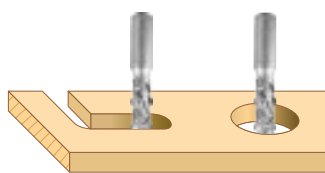



Section  
INDEX

DP diamond helical router bit Z2+2, high density metal body, H 3.5 mm

Diamant-Spiralfräser Z2+2 mit Körper aus Schwermetall HDM PKD H 3,5 mm

fresa de diamante helicoidal Z2+2 con cuerpo en metal pesado HDM y plaquita en DP de H 3,5 mm

Fraise en diamant hélicoïdale Z2+2 avec corps en HDM métal lourd DP H 3,5 mm

Алмазная спиральная фреза Z2+2 корпус из HDM (тяжелый металл) DP H 3,5 mm

INDEX  
by article

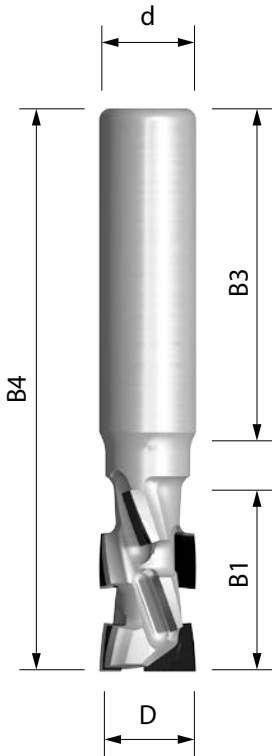

NESTING

ANGOLO ASSIALE  
AXIAL ANGLE

25°

+ NEGATIV

3,5 mm.

FORANTE / DRILL

DP

CORPO / BODY

HDM  
METALLO  
PESANTE

PRICE  
LIST

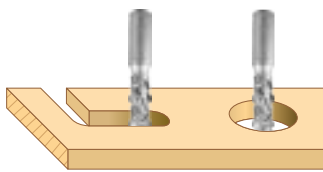

Cod.	D mm	B1 mm	B3 mm	B4 mm	d mm	Z tot	rpm max
D259 10	12	19	40	65	12	2+2 (6)	24000
D259 11	12	22	40	70	12	2+2 (8)	24000
D259 12	12	24	40	70	12	2+2 (8)	24000
D259 13	12	29	40	75	12	2+2 (10)	24000
D259 14	14	24	50	80	16	2+2 (8)	24000
D259 15	14	29	50	85	16	2+2 (10)	24000
D259 16	14	35	50	91	16	2+2 (12)	24000
D259 17	16	24	50	80	16	2+2 (8)	24000
D259 18	16	29	50	85	16	2+2 (10)	24000
D259 19	16	35	50	91	16	2+2 (12)	24000

Fresa in diamante riaffilabile ad elica interrotta con quattro divisioni, due taglienti in presa su tutti i livelli, elica prevalentemente negativa, altezza DP 3,5 mm, corpo in metallo pesante HDM, adatta per lavorazioni di nesting su pannelli nobilitati, rivestiti, laminati, M.D.F. Taglienti positivi/negativi, altissima velocità di avanzamento, estrazione del truciolo, eccellente finitura, bassa rumorosità.

Re-sharpening shank cutter with split tips on six helicoidal wings, three engaged cutters on top and bottom parts, mainly negative helix, HDM (High density metal) body, DP 3,5 mm. Tool suitable for nesting operation on chipboard panels laminate, coated or on MDF, OSB, cutters positive/negative, high working speed, good evacuation of chips, excellent finishing and low noise.

Nachschleifbarer, mehrschneidiger Diamantfräser, vier Schneidereien, zwei eingreifende Schneiden auf jeder Ebene, vorwiegend negativer Achswinkel, Höhe PKD 3,5 mm, Körper aus Schwermetall HDM, geeignet für Nesting-Bearbeitungen an veredelten, beschichteten, laminierten und MDF-Platten. Positiv/negativ, hohe Vorschubgeschwindigkeit, Spanabfuhr, hervorragende Oberflächengüte, geringe Geräuschentwicklung.

Fresa de diamante reaflable con hélice dividida en cuatro secciones, dos filos cortantes que cortan a cualquier nivel, hélice principalmente con ángulo de corte negativo, plaquita en DP de 3,5 mm de altura y cuerpo en metal pesado HDM. Es ideal para operaciones de nesting en paneles de melamina, MDF, revestidos y laminados. Se caracteriza por filos cortantes con ángulo de corte positivo y negativo, elevada velocidad de avance, extracción de la viruta, excelente acabado y poco ruido.

Fraise en diamant réaffûtable à hélice interrompue avec 4 divisions, 2 coupes en prise sur tous les niveaux, hélice principalement négative, DP H. 3,5, corps en métal lourds HDM, adapté pour l'usinage nesting sur panneaux anoblis, revêtus, laminés, MDF. Coupes positives/négatives, très haute rapidité d'avancement, extraction des copeaux, excellente finition, bruit réduit.

Алмазная фреза, заточиваемая с прерванной спиралью и 4-я делениями. 2 ножи в функционировании на каждом уровне, спираль в основном негативная, высота DP 3,5 mm, корпус из тяжёлого металла HDM. Отлично подходит для обработок nesting шпонированных панелей, панелей с покрытием, ламината, M.D.F. Положительные / отрицательные ножи, очень высокая скорость подачи, удаление стружки, отличный результат в финальной обработке, низкий уровень шума.

DP diamond helical router bit Z3+3, high density metal body, H 3.5 mm

Diamant-Spiralfräser Z3+3 mit Körper aus Schwermetall HDM PKD H 3,5 mm

fresa de diamante helicoidal Z3+3 con cuerpo en metal pesado HDM y plaquita en DP de H 3,5 mm

Fraise en diamant hélicoïdale Z3+3 avec corps en HDM métal lourd DP H 3,5 mm

Алмазная спиральная фреза Z3+3 корпус из HDM (тяжелый металл) DP H 3,5 mm

Section INDEX

INDEX by article

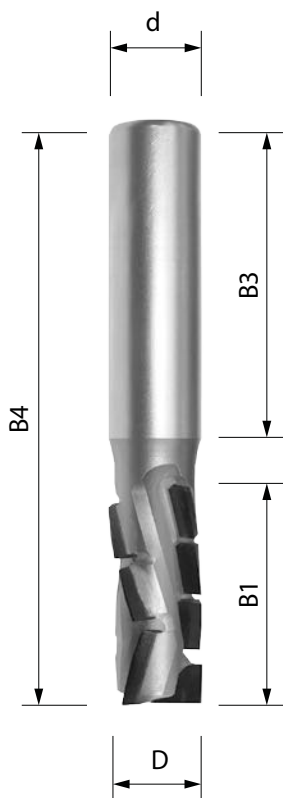

NESTING

ANGOLO ASSIALE AXIAL ANGLE

20°

+ NEGATIV

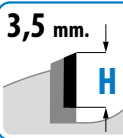

FORANTE / DRILL



CORPO / BODY

HDM METALLO PESANTE

PRICE LIST

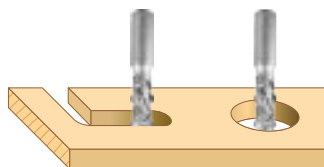

Cod.	D mm	B1 mm	B3 mm	B4 mm	d mm	Z tot	rpm max
D241 10	12	21	40	70	12	3+3 (8)	24000
D241 11	12	25	40	75	12	3+3 (10)	24000
D241 12	12	27	40	75	12	3+3 (11)	24000
D241 13	12	32	40	75	12	3+3 (13)	24000
D241 14	14	27	50	85	16	3+3 (11)	24000
D241 15	14	32	50	85	16	3+3 (13)	24000
D241 16	16	27	50	85	16	3+3 (11)	24000
D241 17	16	37	50	90	16	3+3 (15)	24000
D241 18	16	45	50	108	16	3+3 (19)	24000

Fresa in diamante riaffilabile ad elica interrotta con tre divisioni, tre taglienti in presa, lato superiore ed inferiore, elica prevalentemente negativa, corpo in HDM o ACCIAIO, altezza DP H3,5 mm. Adatta per lavorazioni di nesting, taglienti positivi/negativi, alta velocità di avanzamento, estrazione del truciolo, buona finitura e bassa rumorosità.

Re-sharpening shank cutter with split tips on three helicoidal wings, three engaged cutters on top and bottom parts, mainly negative helix, HDM or STEEL body, DP H3,5 mm. Tool suitable for nesting operation, cutters positive/negative, high working speed, good evacuation of chips, excellent finishing and low noise.

Nachschleifbarer, mehrschneidiger Diamantfräser mit drei Schneidereien, drei eingreifende Schneiden, oben und unten, vorwiegend negativer Achswinkel, Körper aus HDM oder STAHL, Höhe PKD H 3,5 mm. Geeignet für Nesting-Bearbeitungen, positive/negative Schneiden, hohe Vorschubgeschwindigkeit, Spanabfuhr, gute Oberflächengüte und geringe Geräusentwicklung.

Fresa de diamante reafilable con hélice dividida en tres secciones, tres filos cortantes que cortan en la parte superior e inferior, hélice principalmente con ángulo de corte negativo, cuerpo en metal pesado HDM o ACERO y plaquita en DP de 3,5 mm de altura. Es ideal para operaciones de nesting. Se caracteriza por filos cortantes con ángulo de corte positivo y negativo, elevada velocidad de avance, extracción de la viruta, buen acabado y poco ruido.

Fraise en diamant réaffûtable à hélice interrompue avec 3 divisions, 3 coupes en prise, coté supérieur et inférieur, hélice principalement négative, corps en HDM ou ACIER, DP H. 3,5. Adapté pour l'usinage nesting, coupes positives/négatives, haute rapidité d'avancement, extraction des copeaux, bonne finition, bruit réduit.

Алмазная фреза, затачиваемая с прерванной спиралью и 3-я делениями. 3 ножи в функционировании сверху и снизу, спираль в основном негативная, высота DP 3,5 мм, корпус из тяжелого металла HDM или сталь. Отлично подходит для обработок nesting, положительные/ отрицательные ножи, очень высокая скорость подачи, удаление стружки, хороший результат в финальной обработке, низкий уровень шума.

# Art. D243

## fresa in diamante elicoidale Z3+3 con corpo in HDM metallo pesante DP H 3,5 mm

Section INDEX

DP diamond helical router bit Z3+3, high density metal body, H 3.5 mm

Diamant-Spiralfräser Z3+3 mit Körper aus Schwermetall HDM PKD H 3,5 mm

fresa de diamante helicoidal Z3+3 con cuerpo en metal pesado HDM y plaquita en DP de H 3,5 mm

Fraise en diamant helicoidal Z3+3 avec corps en HDM métal lourd DP H 3,5 mm

Алмазная спиральная фреза Z3+3 корпус из HDM (тяжелый металл) DP H 3,5 mm

INDEX by article

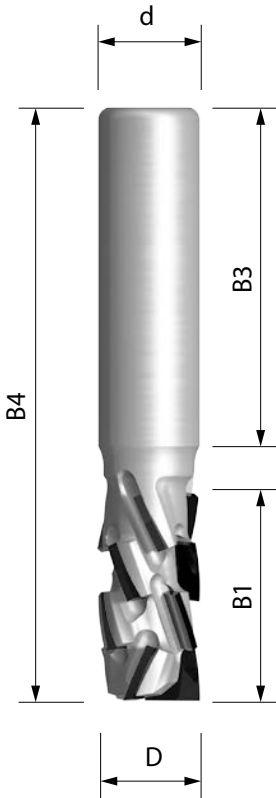

NESTING

ANGOLO ASSIALE AXIAL ANGLE

25°

+ NEGATIV

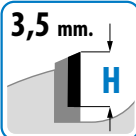

FORANTE / DRILL



CORPO / BODY

HDM METALLO PESANTE

PRICE LIST

Cod.	D mm	B1 mm	B3 mm	B4 mm	d mm	Z tot	rpm max
D243 10	12	19	40	65	12	3+3 (9)	24000
D243 11	12	22	40	70	12	3+3 (12)	24000
D243 12	12	24	40	70	12	3+3 (12)	24000
D243 13	12	29	40	75	12	3+3 (15)	24000
D243 14	14	24	50	80	16	3+3 (12)	24000
D243 15	14	29	50	85	16	3+3 (15)	24000
D243 16	14	35	50	91	16	3+3 (18)	24000
D243 17	16	24	50	80	16	3+3 (12)	24000
D243 18	16	29	50	85	16	3+3 (15)	24000
D243 19	16	35	50	91	16	3+3 (18)	24000

Fresa in diamante Z3+3 efficaci, corpo fresa in HDM (metallo pesante), angolo assiale prevalentemente negativo, 6 divisioni, placchetta DP H3,5 mm. Ottima per lavorazione di pannelli in truciolare rivestito e MDF rivestito. Ideale per lavorazione nesting ad alte velocità di avanzamento.

Re-sharpening shank cutter with split tips on six helical wings, three engaged cutters on top and bottom parts, mainly negative helix, HDM (High density metal) body, DP 3,5 mm. Tool suitable for nesting operation on chipboard panels laminate, coated or on MDF, OSB, cutters positive/negative, high working speed, good evacuation of chips, excellent finishing and low noise.

Diamantfräser Z3+3 effektiv, Schneidkörper aus HDM (Schwermetall), vorwiegend negativer Achswinkel, 6 Schneidreihen, Schneide DP H 3,5 mm. Ideal zur Bearbeitung von beschichteten Spanplatten und MDF. Ideal für die Nesting-Bearbeitung bei hoher Vorschubgeschwindigkeit.

Fresa de diamante Z3+3 (3 cortes efectivos), cuerpo en metal pesado HDM, ángulo axial principalmente negativo, 6 secciones y plaquita de DP H. 3,5 mm de altura. Es ideal para mecanizar paneles de aglomerado revestido y MDF revestido. Es adecuada para operaciones de nesting con elevadas velocidades de avance.

Fraise en diamant Z3+3, corps de fraise en HDM (métal lourd), angle axial principalement négatif, 6 divisions, plaquettes H3,5 mm. Optimal pour l'usinage de panneaux agglomérés revêtus et MDF revêtu. Idéal pour l'usinage nesting à haute rapidité d'avancement.

Алмазная фреза с Z3+3 (фактические), корпус из тяжёлого металла HDM. Осевой кут в основном негативный, 6 делений, ножи DP H3,5 mm. Отлично подходит для обработок nesting с высокой скоростью подачи, ДСП с покрытием и МФД панелей с покрытием.

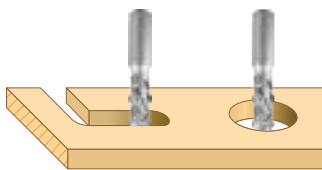

DP diamond helical router bit Z3+3, HDM heavy metal body, H 3.5 mm

Diamant-Spiralfräser Z3+3 mit Körper aus Schwermetall HDM PKD H 3,5 mm

fresa de diamante helicoidal Z3+3 con cuerpo en metal pesado HDM y plaquita en DP de H 3,5 mm

Fraise en diamant hélicoïdale Z3+3 avec corps en HDM métal lourd DP H 3,5 mm

Алмазная спиральная фреза Z3+3 с корпусом HDM (тяжелый металл) DP H 3,5 mm

Section INDEX

INDEX by article

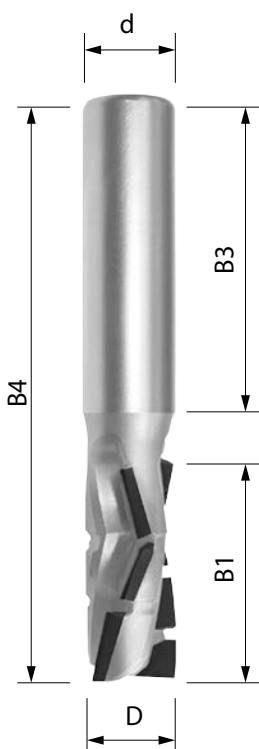

**NESTING**

ANGOLO ASSIALE AXIAL ANGLE

20°

+ POSITIV

3,5 mm.

FORANTE / DRILL

DP

CORPO / BODY

**HDM**  
METALLO PESANTE

**PRICE LIST**

Cod.	D mm	B1 mm	B3 mm	B4 mm	d mm	Z tot	rpm max
D242 10	12	27	40	75	12	3+3 (10)	24000
D242 11	12	35	40	83	12	3+3 (13)	24000
D242 12	16	27	50	85	16	3+3 (10)	24000
D242 13	16	35	50	93	16	3+3 (13)	24000

Fresa in diamante riaffilabile ad elica interrotta con tre divisioni, tre taglienti in presa, lato superiore ed inferiore, elica prevalentemente positiva, corpo in HDM, altezza DP H3,5 mm. Adatta per lavorazioni di nesting, taglienti positivi/negativi, alta velocità di avanzamento, estrazione del truciolo, buona finitura e bassa rumorosità.

Re-sharpening shank cutter with split tips on three helicoidal wings, three engaged cutters on top and bottom parts, mainly positive helix, HDM (High density metal) body, DP H3,5 mm. Tool suitable for nesting, cutters positive/negative, high working speed, good evacuation of chips, excellent finishing and low noise.

Nachschleifbarer, mehrschneidiger Diamantfräser mit drei Schneidreihen, drei eingreifende Schneiden, oben und unten, vorwiegend positivem Achswinkel, Körper aus HDM, Höhe PKD H 3,5 mm. Geeignet für Nesting-Bearbeitungen, positive/negative Schneiden, hohe Vorschubgeschwindigkeit, Spanabfuhr, gute Oberflächengüte und geringe Geräuschentwicklung.

Fresa de diamante reafilable con hélice dividida en tres secciones, tres filos cortantes que cortan en la parte superior e inferior, hélice principalmente con ángulo de corte positivo, cuerpo en metal pesado HDM y plaquita en DP de 3,5 mm de altura. Es ideal para operaciones de nesting. Se caracteriza por filos cortantes con ángulo de corte positivo y negativo, elevada velocidad de avance, extracción de la viruta, buen acabado y poco ruido

Fraise en diamant réaffûtable à hélice interrompue avec trois divisions, trois coupe en prise, coté supérieur et inférieur, hélice principalement positive, corps en HDM, hauteur DP H 3,5 mm. Adaptée pour l'usinage de nesting, coupes positives/négatives, haute rapidité d'avancement, extraction du copeau, bonne finition et bruit réduit.

Алмазная заточиваемая фреза с «прерванной спиралью» с 3-я делениями, 3-я режущими элементами снизу и сверху. Спираль в основном положительная, корпус из HDM, высота DP H3,5 mm. Сфера применения — обработка nesting; ножи положительно-отрицательные; высокая скорость работы и подачи; экстракция стружки, качественная обработка и низкочужность в работе.

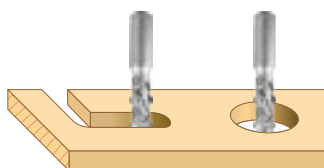

Section INDEX

DP diamond helical router bit Z2+2, steel body, H 4.5 mm

Diamant-Spiralfräser Z2+2 mit Körper aus Stahl, PKD H 4,5 mm

fresa de diamante helicoidal Z2+2 con cuerpo en acero y plaquita en DP de H 4,5 mm

Fraise en diamant hélicoïdale Z2+2 avec corps en acier DP H 4,5 mm

Алмазная спиральная фреза Z2+2 корпус из стали DP H 4,5 mm

INDEX by article

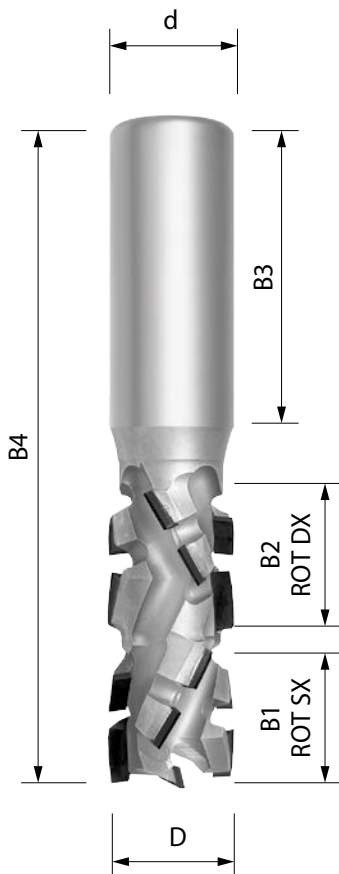

ANGOLO ASSIALE AXIAL ANGLE  
**30°**

+ NEGATIV

4,5 mm.  
H

FORANTE / DRILL  
DP

Cod.	D mm	B1 mm	B2 mm	B3 mm	B4 mm	d mm	Z tot	rpm max
D248 10	25	25	25	55	120	25	2+2 (17)	24000
D248 11	25	31	31	55	132	25	2+2 (21)	24000
D248 12	25	36	36	55	142	25	2+2 (25)	24000
D248 13	25	41	41	55	152	25	2+2 (29)	24000
D248 14	25	47	47	55	164	25	2+2 (33)	24000
D248 15	25	52	52	55	174	25	2+2 (37)	24000
D248 16	25	57	57	55	184	25	2+2 (41)	24000
D248 17	25	63	63	55	196	25	2+2 (45)	24000
D248 18	25	68	68	55	206	25	2+2 (49)	24000

Fresa in diamante Z2+2 doppia rotazione DX/SX, con placchetta riaffilabile H4,5 mm (max 8 riaffilature), 4 divisioni in elica, prima placchetta positiva traente con il resto delle placchette negative. Forante in diamante, corpo in acciaio speciale, angolo assiale di 30° per ottenere ottime finiture sul pannello. Ottima per lavorazione di pannelli in truciolare rivestito, MDF rivestito e multistrato rivestito.

Fresa de diamante Z2+2 con doble rotación DER/IZQ, plaquita de 4,5 mm de altura (reafilable 8 veces, como máximo), cuatro secciones en cada hélice, la primera plaquita con ángulo de corte positivo y las demás negativo. Broca para taladrar en diamante, cuerpo en acero especial y ángulo axial de 30° para obtener excelentes acabados en el panel. Es ideal para mecanizar paneles de aglomerado revestido, MDF revestido y contrachapado revestido.

DP helicoidal shank cutter Z2+2 double rotation LH/RH with DP tips H4,5 mm resharpened up to 8 times, four helicoidal wing, first tip positive all the others negative, plunge tip in DP steel body cutting angle 30°. Suitable for working on laminated chipboard panels, plywood, laminated and laminated MDF.

Fraise en diamant Z2+2 à double rotation D/G, avec plaquette réaffûttable H4,5 mm (max 8 réaffutage), 4 divisions en hélice, première plaquette positive qui entraîne le reste des plaquettes négatives. Perceur en diamant, corps en acier spécial, angle axial de 30° pour obtenir des finitions optimales sur panneaux, contreplaqué, laminés, MDF.

Diamantfräser Z2+2, Rechts- und Linksdrill, Schneide H 4,5 mm (max. 8 Mal nachschleifbar), 4 Schneidereien, die erste ziehende Schneide positiv, die anderen negativ. Einbohrschneide aus Diamant, Körper aus Sonderstahl, Achswinkel 30° für eine hervorragende Oberflächengüte der Platten. Ideal für die Bearbeitung von beschichteten Spanplatten, beschichtetem MDF und Mehrschichtplatten.

Алмазная фреза Z2+2 двойного вращения DX/SX с затачиваемыми ножами H4,5 мм (макс. 8 раз заточка), 4 деления спирали, первая пластина несущая положительная, остальные отрицательные. Сверло из алмаза, корпус из специальной стали, осевой угол 30° что позволяет получить отличную обработку панели. Отлично подходит для обработки панелей МФ.

PRICE LIST

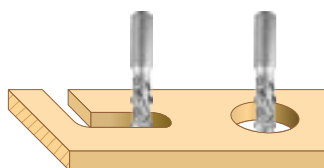

DP diamond helical router bit Z3+3, steel body, H 4.5 mm

Diamant-Spiralfräser Z3+3 mit Körper aus Stahl, PKD H 4,5 mm

fresa de diamante helicoidal Z3+3 con cuerpo en acero y plaquita en DP de H 4,5 mm

Fraise en diamant hélicoïdale Z3+3 avec corps en acier DP H 4,5 mm

Алмазная спиральная фреза Z3+3 корпус из стали DP H 4,5 mm

Section INDEX

INDEX by article

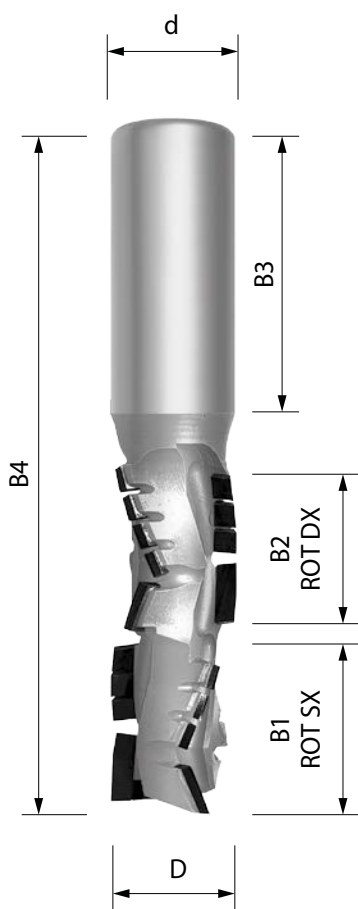

ANGOLO ASSIALE  
AXIAL ANGLE  
**25°**

+ NEGATIV

4,5 mm.  
H

FORANTE / DRILL  
DP

Cod.	D mm	B1 mm	B2 mm	B3 mm	B4 mm	d mm	Z tot	rpm max
D249 10	25	30	30	55	95	25	3+3 (26)	24000
D249 11	25	35	35	55	100	25	3+3 (32)	24000
D249 12	25	40	40	55	105	25	3+3 (38)	24000
D249 13	25	45	45	55	110	25	3+3 (44)	24000
D249 14	25	50	50	55	115	25	3+3 (50)	24000
D249 15	25	55	55	55	120	25	3+3 (56)	24000
D249 16	25	62	62	55	127	25	3+3 (62)	24000
D249 17	25	67	67	55	132	25	3+3 (68)	24000

Fresa in diamante Z3+3 doppia rotazione DX/SX, con placchetta riaffilabile H4,5 mm (max 8 riaffilature), 3 divisioni in elica. Forante in diamante, angolo assiale da 20°+/- . Ottima per lavorazione di pannelli in truciolare rivestito e MDF rivestito.

DP helicoidal shank cutter Z3+3 double rotation LH/RH with DP tips H4,5 mm resharpened up to 8 times, three helicoidal wing, plunge tip in DP steel body cutting angle 20°. Suitable for working on laminated chipboard panels and laminated MDF.

Diamantfräser Z3+3, Rechts- und Linksdrill, mit Schneide H 4,5 mm (max. 8 Mal nachschleifbar), 3 Schneidereien. Einbohrschneide aus Diamant, Achswinkel 20°+/- . Ideal zur Bearbeitung von beschichteten Spanplatten und MDF.

Fresa de diamante Z3+3 con doble rotación DER/IZQ, plaquita de 4,5 mm de altura (reafilable 8 veces, como máximo) y tres secciones en cada hélice. Broca para taladrar en diamante, ángulo axial de 20° +/- . Es ideal para mecanizar paneles de aglomerado revestido y MDF revestido.

Fraise en diamant Z3+3 à double rotation D/G, avec plaquette réaffûtable H4,5 mm (max 8 réaffûtages), 3 divisions en hélice. Perceur en diamant, angle axial de 20° +/- . Optimale pour l'usinage de panneaux agglomérés revêtus et MDF revêtu.

Алмазная фреза Z3+3 двойного вращения DX/SX с затачиваемыми ножами H4,5 мм (макс. 8 раз заточка), 3 деления спирали. Сверло из алмаза, корпус из специальной стали, осевой угол 20° +/- . Отлично подходит для панелей ДСП с покрытием и МДФ панелей с покрытием.

PRICE LIST

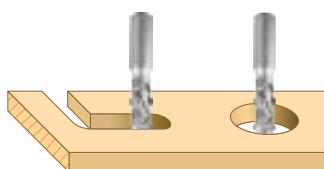

# Art. D820

## ghiera turbo con turbina per estrazione trucioli

turbo ring for chip removal

Turbo-Ringfräser mit Turbine für die Spanabfuhr

casquillo turbo con turbina para extracción de virutas

collier turbo avec turbine pour l'extraction des copeaux

Турбо-гайка с турбиной для удаления стружки

Section INDEX

INDEX by article



PRICE LIST



Cod.	Ø mm	Dimensioni	Dimensions
D820 10	100	HSK63F ER32	
D820 11	100	HSK63F ER40	

Ghiera con turbina di estrazione del truciolo applicabile sui mandrini HSK ER32, HSK ER40 e EOC25 (DIN6388). La turbina sostituisce la ghiera standard. Massima estrazione del truciolo sul piano lavorato. Raccomandato per operazioni di nesting. L'estrazione del truciolo permette un aumento di durata e finitura dell'utensile. Il corpo in lega della turbina non genera vibrazioni alla macchina. Possibilità di utilizzo dai 6000 rpm fino ai 20000 rpm. Materiali lavorabili: truciolare, MDF, corian, OSB, multistrato, materiali plastici. Accorgimenti: utilizzare la turbina il più possibile vicino al pannello garantendo una maggiore pressione di estrazione del truciolo (da 1 a 2 mm dal piano di lavoro).

Ring nut with chip extraction turbine applicable to HSK ER32, HSK ER40 and EOC25 (DIN6388) tool holders. The turbine replaces the standard ring nut. Maximum extraction of the chip on the worked surface. Recommended for nesting operations. Chip extraction allows an increase in tool life and finish. The alloy body of the turbine does not generate vibrations to the machine. Possibility of use from 6000 rpm up to 20000 rpm. Suitable to work on chipboard, MDF, corian, OSB, multilayer, plastic materials. Attention: use the turbine as close to the panel as possible, guaranteeing greater chip removal pressure (from 1 to 2 mm from the worktop).

Ring mit Turbine für die Spanabfuhr, passend für Spindeln HSK ER32, HSK ER40 und EOC25 (DIN6388). Die Turbine ersetzt den Standardring. Maximale Spanabfuhr an der bearbeiteten Fläche. Empfohlen für Nesting-Bearbeitungen. Die Spanabfuhr ermöglicht eine längere Lebensdauer und eine höhere Bearbeitungsqualität des Werkzeugs. Der Leichtmetallkörper der Turbine verursacht keine Schwingungen der Maschine. Einsatz von 6000 bis 20000 U/min möglich. Bearbeitbare Werkstoffe: Spanplatten, MDF, Corian, OSB, Mehrschichtplatten, Kunststoff. Nutzungshinweise: Die Turbine möglichst nahe an der Platte einsetzen, um den Druck für die Spanabfuhr zu erhöhen (1-2 mm von der Arbeitsfläche).

Casquillo con turbina de extracción de virutas aplicable a mandriles HSK ER32, HSK ER40 y EOC25 (DIN6388). La turbina sustituye el casquillo estándar. Asegura la máxima extracción de las virutas en la superficie mecanizada. Se recomienda para operaciones de nesting. La extracción de las virutas alarga la vida útil de la herramienta y mejora el acabado. El cuerpo en aleación de la turbina no genera vibraciones en la máquina. Posibilidad de utilización desde 6000 rpm hasta 20000 rpm. Materiales a mecanizar: paneles de aglomerado, contrachapado, MDF, Corian, OSB, materiales plásticos. Precaución: utilice la turbina lo más posible cerca del panel a fin de garantizar mayor presión de extracción de la viruta (de 1 a 2 mm desde la superficie de trabajo).

Collier avec turbine d'extraction de copeaux applicable sur mandrins HSK ER 32, HSK ER 40, EOC25 (DIN6388). La turbine substitue le collier standard. Extraction maximale du copeau sur le plan de travail. Recommandé pour les opérations de nesting, l'extraction du copeau permet une augmentation de la durée et de la finition de l'outil. Le corps en alliage de la turbine ne provoque pas de vibration à la machine. Possibilité d'utilisation de 6000 rpm jusqu'à 20000 rpm. Matériel usinable : aggloméré, MDF, corian, OSB, multicouche, matériel plastique. Précautions : utiliser la turbine le plus possible proche du panneau pour garantir une pression majeure d'extraction du copeau (de 1 à 2 mm du plan de travail).

Гайка с турбиной для экстракции стружки применимая для патронов HSK ER32, HSK ER40 и EOC25 (DIN6388) Турбина заменяет стандартную кольцевую гайку. Максимальное удаление стружки на обрабатываемой поверхности. Рекомендуется для операций nesting. Извлечение стружки увеличивает долговечность и чистоту инструмента. Корпус турбины из сплава не генерирует вибрации в станке. Возможность использования от 6000 об./мин. до при 20000 об./мин. Обрабатываемые материалы: ДСП, МДФ, кориан, OSB, многослойные панели, пластиковые материалы. Рекомендации: используйте турбину как можно ближе к панели, это обеспечит большое давления при извлечении стружки (от 1 до 2 мм на рабочей поверхности).

# Art. D836

## chiave a settore din 1810 per ghiera turbo 820

DIN 1810 c-spanner for turbo ring 820

Hakenschlüssel DIN 1810 für Turbo-Ringfräser 820

llave de gancho DIN 1810 para casquillo turbo 820

clé à secteur din 1810 pour collier turbo 820

Специальный ключ din 1810 для турбо-гайки 820



PRICE LIST

Cod.	Dimensioni	Dimensions
D836 10	Diametro ghiera / Nut diameter 95-100	



diamond router bit for planing Z3 / Z4 / Z6, steel body, H 4.5 mm

Diamant-Spiralfräser zum Planfräsen Z3 / Z4 / Z6, Körper aus Stahl, PKD H 4,5 mm

fresa de diamante Z3 / Z4 / Z6 para nivelar con cuerpo en acero y plaquita en DP de H 4,5 mm

Fraise en diamant pour aplanir Z3 / Z4 / Z6 avec corps en acier DP H 4,5 mm

Алмазная фреза Z3 / Z4 / Z6 для строганий, корпус из стали DP H 4,5 mm

Section INDEX

INDEX by article

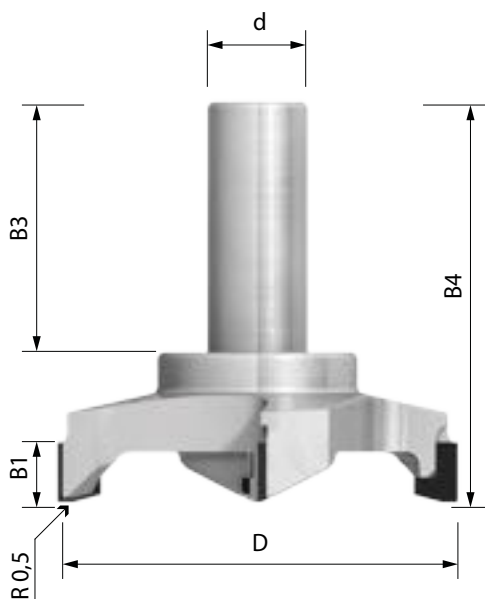

Cod.	D mm	B1 mm	B3 mm	B4 mm	d mm	Z tot	rpm max
D256 10	60	12	40	75	12	3	24000
D256 11	60	12	50	80	20	4	24000
D256 12	80	12	50	80	20	4	24000
D256 13	100	12	50	85	20	4	24000
D256 14	100	12	50	85	20	6	24000

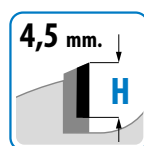

PRICE LIST

Fresa in diamante per spianare piani in MDF e per fare battute. Angolo assiale 0° e raggio 0,5 sullo spigolo laterale per evitare segni di spianatura.

Diamond milling cutter for flattening MDF surfaces and for making jokes. Axial angle 0° and radius 0.5 on the lateral edge to avoid flattening marks.

Diamantfräser zum Planfräsen von MDF-Platten und Fälzen. Achswinkel 0° und Radius 0,5 an der Seitenkante, um Abtragungsspuren zu vermeiden.

Fresa de diamante para nivelar superficies de MDF y para realizar topes. Ángulo axial de 0° y radio de 0,5 en el canto lateral para no dejar marcas de nivelado.

Fraise en diamant pour aplanir panneaux en MDF et pour faire des feuillures. Angle axial à 0° et rayon de 0,5 sur l'arête latérale pour éviter des trace de surfaçage.

Алмазная фреза для выравнивания поверхности из MDF и обработки притвора. Осевой угол 0° и радиус 0,5 на боковом краю, чтобы избежать дефектов обработки.

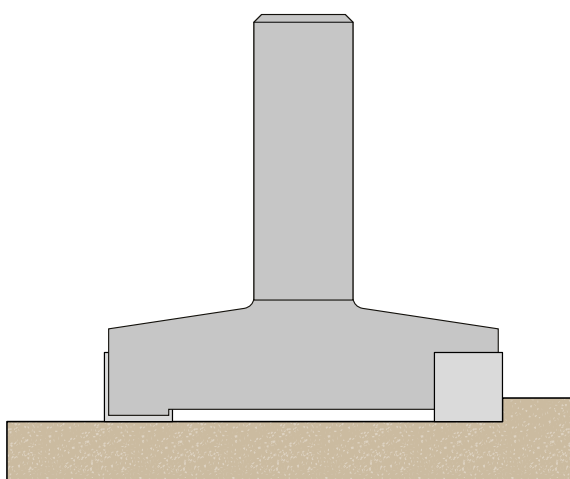



Section  
INDEX

DP diamond cutter Z2+2 for door locks with high density metal body, H 3.5 mm

Diamant-Spiralfräser Z2+2 für Türschlösser mit Körper aus Schwermetall HDM PKD H 3,5 mm

fresa de diamante Z2+2 para cerraduras de puertas con cuerpo en metal pesado HDM y plaquita en DP de H 3,5 mm

Fraise en diamant Z2+2 pour serrure de portes avec corps en HDM métal lourd DP H 3,5 mm

Алмазная спиральная фреза Z2+2 для дверных замков, корпус HDM (тяжелый металл) DP H 3,5 mm

INDEX  
by article

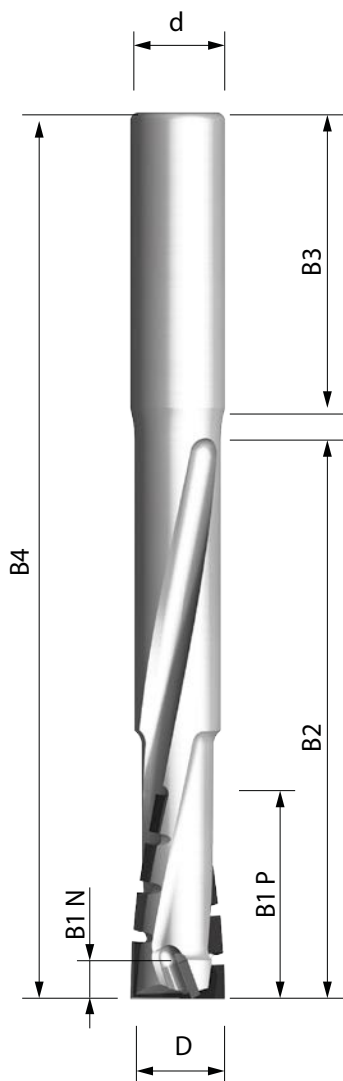

ANGOLO ASSIALE  
AXIAL ANGLE  
**10°**

POSITIV  
NEGATIV

3,5 mm.  
H

FORANTE / DRILL  
DP

CORPO / BODY  
HDM  
METALLO  
PESANTE

PRICE  
LIST

Cod.	D mm	B1 P mm	B1 N mm	B2 mm	B3 mm	B4 mm	d mm	Z tot	rpm max
D252 10	14	22	2+2	90	50	150	14	4	24000
D252 11	14	22	2+2	90	50	150	16	4	24000
D252 12	16	22	2+2	90	50	150	16	4	24000
D252 13	16	22	2+2	110	50	170	16	4	24000
D252 14	18	22	2+2	90	50	150	18	4	24000
D252 15	18	22	2+2	110	50	170	18	4	24000
D252 16	14	34	2+2	90	50	150	14	4	24000
D252 17	14	34	2+2	90	50	150	16	4	24000
D252 18	16	34	2+2	90	50	150	16	4	24000
D252 19	16	34	2+2	110	50	170	16	4	24000

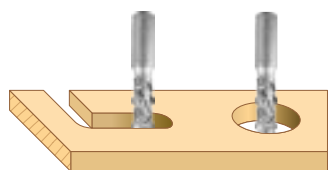

Fresa elica per cave di serrature porte, speciale geometria costruttiva, eccellente finitura nella parte esterna della piastrina e elevata capacità di asportazione all'interno della cava. Corpo in metallo pesante per ridurre notevolmente le vibrazioni aumentando la durata del tagliente, si raccomanda ingresso in interpolazione a rampa.

DP helicoidal shank cutter for machining door locks with body anti-vibration in HDM (High density metal). The two negative tips give a good finishing during the operation for the slot the others two positive tips with chip breaker help the evacuation of wooden chips from the slot.

Spiralfräser für Schlosstaschen, spezielle konstruktive Geometrie, hervorragende Oberflächengüte an der Außenseite der Rosette und hoher Materialabtrag in der Tasche. Schwermetallkörper für eine erhebliche Reduzierung der Schwingungen und eine längere Lebensdauer der Schneide. Es empfiehlt sich, mittels Rampe einzutauchen.

Fresa helicoidal para realizar las ranuras para las cerraduras de las puertas. Cuenta con una forma especial, excelente acabado en la parte exterior de la plaquita y elevada capacidad de extracción en el interior de la ranura. Cuerpo en metal pesado para reducir considerablemente las vibraciones aumentando la duración del filo cortante. Se recomienda la introducción de la herramienta mediante interpolación helicoidal.

Fraise hélice pour rainure de serrure de porte, construction à géométrie spéciale, excellente finition de la partie externe de la plaquette et capacité d'enlèvement élevée à l'intérieur de la rainure. Corps en métal lourd pour réduire énormément les vibrations et en augmentant la durée de la plaquette. On recommande de pénétrer de la façon inclinée.

Фреза спиральная для выборки гнезд дверных замков. Специальная геометрия конструкции, отличная отделка на внешней стороне пластины, высокая производительность при удалении изнутри. Тяжёлый металлический корпус, который значительно понижает вибрацию, увеличивая срок службы режущей пластины. Осторожно на входе в рампу интерполяции.

# Art. D309

## fresa in diamante per giunzioni lamello Clamex P-System Z1 corpo in HDM metallo pesante DP H 3 mm

DP diamond cutter Z1 for Lamello Clamex P-system connectors, high density metal body, H 3

Diamantfräser für Lamelloverbindungen Clamex P-System Z1 mit Körper aus Stahl, PKD H 3 mm

fresa de diamante Z1 para ensamblaje con galleta Clamex P-System con cuerpo en acero y plaquita en DP de H 3 mm

fraise en diamant pour aboutage lamello Clamex P-System Z1 corps en acier DP H 3 mm

Алмазная фреза для сращиваний ламели Clamex P-System, корпус HDM (тяжелый металл) DP H 3 mm

Section INDEX

INDEX by article

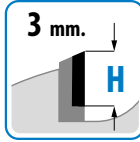
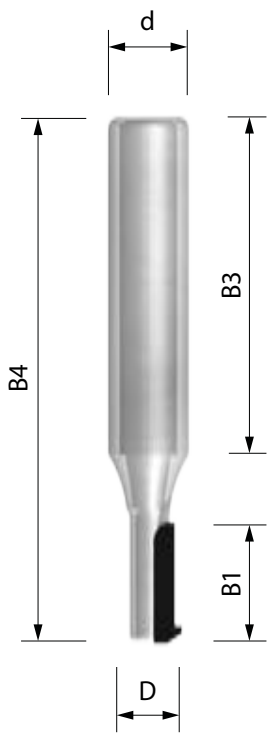

PRICE LIST

Cod.	D mm	B1 mm	B3 mm	B4 mm	d mm	Z tot	rpm max
D309 10	7	18	50	78	12	1	24000

Fresa in diamante Z1 a tagliante dritto per giunzioni lamello clamex P-system.

DP shank cutter Z1 for lamello.

Diamantfräser Z1 mit gerader Schneide für Lamelloverbindungen Clamex P-System.

Fresa de diamante Z1 con filo cortante recto para ensamblaje con galleta Clamex P-system.

Fraise en diamant Z1 à coupe droite pour aboutage lamello clamex P-system.

Алмазная фреза Z1 с прямой пластиной для сращиваний lamello clamex P-system.

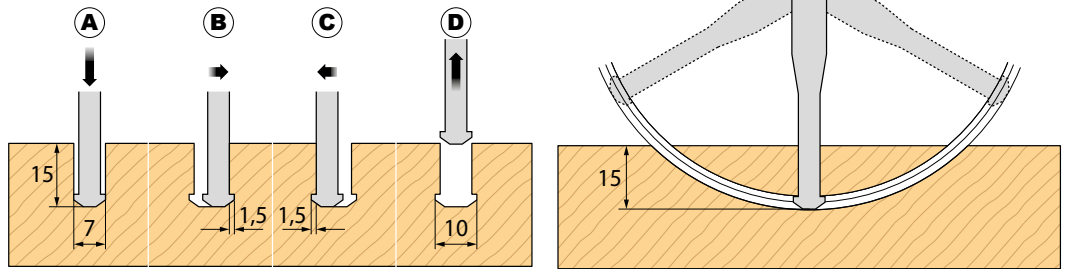

# Art. D351

## fresa HW integrale per giunzioni lamello Clamex P-System Z2

full HW router bit Z2 for Lamello Clamex P-system connectors

Fräser vollständig aus HW für Lamelloverbindungen Clamex P-System Z2

fresa de metal duro integral HW Z2 para ensamblaje con galleta Clamex P-System

fraise HW intégrale pour aboutage lamello Clamex P-System Z2

Цельная фреза HW для сращивания ламели Clamex P-System Z2

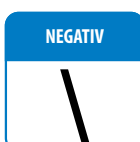
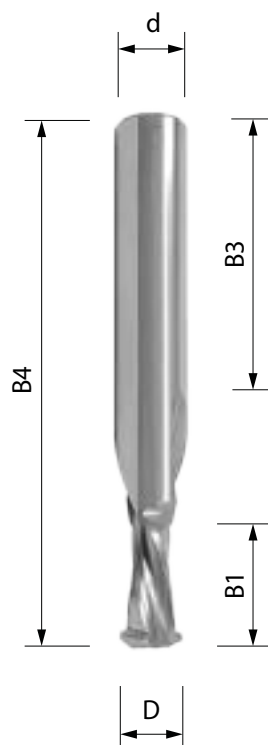

PRICE LIST

Cod.	D mm	B1 mm	B3 mm	B4 mm	d mm	Z tot	rpm max
D351 10	7	18	50	78	12	2	24000

Fresa in hw Z2 negativa per giunzioni lamello clamex P-system.

DP shank cutter Z2 negative for lamello.

Negativer Fräser aus HW Z2 für Lamelloverbindungen Clamex P-System.

Fresa de metal duro HW Z2 con ángulo de corte negativo para ensamblaje con galleta Clamex P-System.

Fraise en hw Z2 négative pour aboutage lamello clamex P-system.

Алмазная фреза HW Z2 отрицательная для сращиваний lamello clamex P-system.

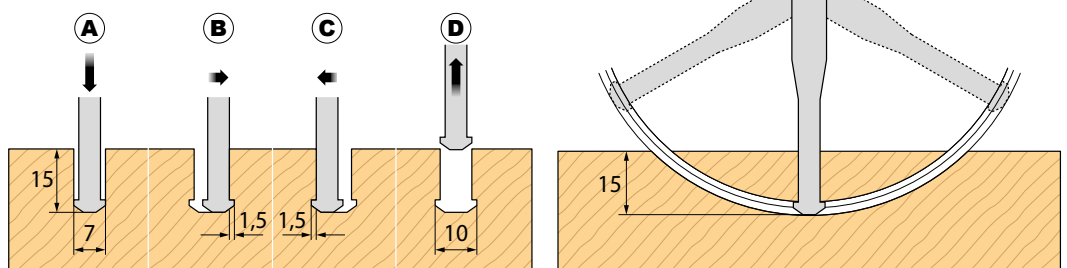

# Art. D833

## albero portalama con attacco cilindrico

blade holder with cylindrical shank

Sägeblattwelle mit Zylinderschaft

eje porta hoja con acoplamiento cilíndrico

arbre porte lame avec queue cylindrique

Вал-держатель пилы с цилиндрическим патроном

Section INDEX

INDEX by article

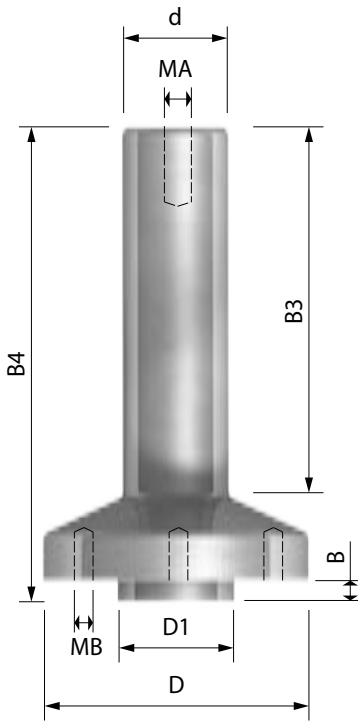

Cod.	D mm	D1 mm	B3 mm	B4 mm	d mm	B mm	MA mm	MB mm	A mm
D833 10	20	20	70	90	20	2,5	M6	M5	35
D833 11	22	22	70	90	20	4	M6	M4	35,9
D833 12	30	30	70	90	20	2,5	M6	M5	45
D833 13	22	22	70	90	16	4	M6	M4	35,9

PRICE LIST

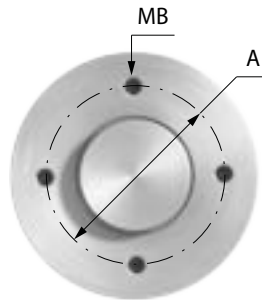

Albero portalama con attacco cilindrico per lamello Clamex F22 e per lame con foro 20/30.

Eje porta hoja con acoplamiento cilíndrico para galleta Clamex F22 y hojas con agujero 20/30

Sawblade tool holder with shank for lamello clamex f22 and sawblades with hole 20/30.

Arbre porte lame avec queue cylindrique pour lamello Clamex F22 et pour lame avec alésage de 20/30.

Sägeblattwelle mit Zylinderschaft für Lamello Clamex F22 und für Sägeblätter mit Bohrung 20/30.

Цилиндрический вал-держатель пил x lamello Clamex F22 и для пил с посадочным D 20/30

# Art. D109

## fresa in diamante per giunzioni lamello Clamex P-System corpo in acciaio DP H 3,5 mm

DP diamond cutter for Lamello Clamex P-system connectors, steel body, H 3.5 mm

Diamantfräser für Lamelloverbindungen Clamex P-System, Körper aus Stahl, PKD H 3,5 mm

fresa de diamante para ensamblaje con galleta Clamex P-System con cuerpo en acero y plaquita en DP de H 3,5 mm

fraise en diamant pour aboutage lamello Clamex P-System corps en acier DP H 3,5 mm

Алмазная фреза для сращиваний ламели Clamex P-System, корпус из стали DP H 3,5 mm

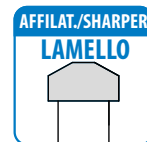
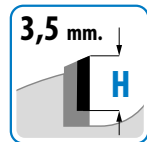

Cod.	ø D mm	B mm	b mm	ø d mm	Z tot	rpm Min - max	FT / PH	MACCHINA MACHINE TYPES
D109 10	100,4	7	4	22	3	7600 - 13000	4(4,2/35,9)	MAN. ZETA P2
D109 11	100,4	7	4	30	3	7600 - 13000	4(6,6/48)	CNC
D109 12	100,4	7	4	22	6	7600 - 13000	4(4,2/35,9)	MAN. ZETA P2
D109 13	100,4	7	4	30	6	7600 - 13000	4(6,6/48)	CNC

Fresa in DP lamello per incastri da utilizzare su macchine CNC e su fresatrice manuale zeta P2.

Fresa in DP para ensamblaje con galleta a utilizar en máquinas CNC y fresadora manual zeta P2.

DP saw blade for LAMELLO jointing system to be used on CNC machines or portable machine Z P2.

Fraise en diamant lamello pour rainures. A utiliser sur CNC et sur fraiseuses manuelles zeta P2.

Lamello-Nutfräser aus PKD für CNC-Maschinen und für den Handfräser Zeta P2.

Фреза из DP lamello для сращиваний. Применение - станок CNC и мануальный фрезерный станок Zeta P2.

PRICE LIST

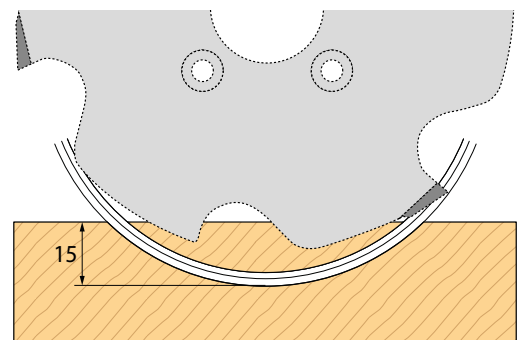
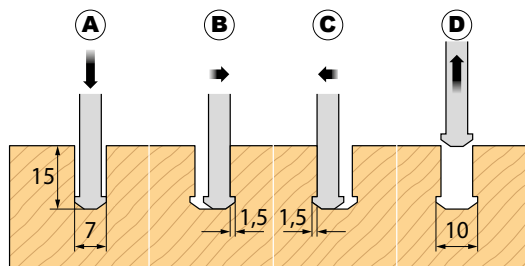
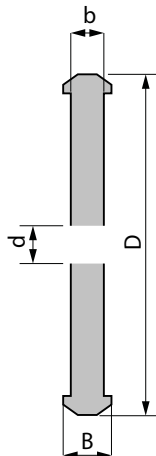

# Art. D701

## punta in diamante foratrice per fori passanti Z1 corpo in acciaio

diamond drill bit Z1 for through holes, steel body

Diamant-Bohrspitze für Durchgangslöcher Z1, Körper aus Stahl

broca de diamante Z1 para taladrar agujeros pasantes con cuerpo en acero

mèche à percer en diamant pour trous passants Z1 corps en acier

Алмазная фреза Z1 для сквозных отверстий, корпус из стали

Section INDEX

INDEX by article

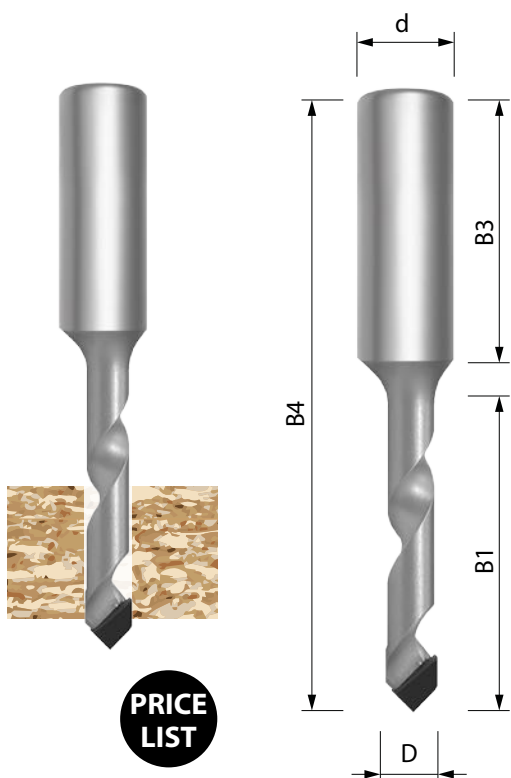

PRICE LIST

Cod. DX / RH	Cod. SX / LH	D mm	B1 mm	B3 mm	B4 mm	d mm	Z tot
D701 10	D701 18	5	28	25	57,5	10	1
D701 11	D701 19	5	40	25	70	10	1
D701 12	D701 20	6	28	25	57,5	10	1
D701 13	D701 21	6	40	25	70	10	1
D701 14	D701 22	8	28	25	57,5	10	1
D701 15	D701 23	8	40	25	70	10	1
D701 16	D701 24	10	28	25	57,5	10	1
D701 17	D701 25	10	40	25	70	10	1

Punta foratrice in diamante ad alto rendimento Z1 per fori passanti, ottima per eseguire fori passanti su pannelli truciolari, rivestiti, laminati, nobilitati, MDF

Broca de diamante Z1 de elevado rendimiento para taladrar agujeros pasantes. Es ideal para realizar agujeros pasantes en paneles de aglomerado, melamina, MDF, revestidos y laminados.

DP through hole drilling bit with high performance Z1. Suitable for through hole on laminated chipboard panels MDF.

Mèche à percer en diamant à haut rendement, Z1, optimale pour exécuter des trous passants sur panneaux agglomérés, revêtus, laminés, anoblis, MDF.

Hochleistungs-Diamant-Bohrspitze Z1 für Durchgangslöcher, ideal für Spanplatten, beschichtete, laminierte, veredelte und MDF-Platten.

Алмазная высокопроизводительная фреза-сверло, Z1 для сквозных отверстий, отличная для выборки сквозных отверстий панелей ДСП, ламинированных, меламиновых, шпонируемых, МДФ панелей.

# Art. D702

## punta in diamante foratrice per fori passanti Z2 corpo in HW

diamond drill bit Z2 for through holes, HW body

Diamant-Bohrspitze für Durchgangslöcher Z2, Körper aus HW

broca de diamante Z2 para taladrar agujeros pasantes con cuerpo en HW

mèche à percer en diamant pour trous passants Z2 corps en HW

Алмазная фреза Z2 для сквозных отверстий, корпус из HW

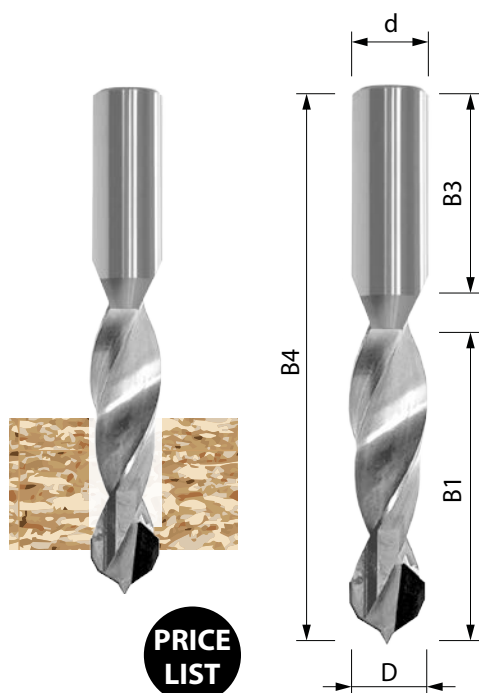

PRICE LIST

Cod. DX / RH	Cod. SX / LH	D mm	B1 mm	B3 mm	B4 mm	d mm	Z tot
D702 10	D702 22	5	28	20	57,5	10	2
D702 11	D702 23	5	40	20	70	10	2
D702 12	D702 24	6	28	20	57,5	10	2
D702 13	D702 25	6	40	20	70	10	2
D702 14	D702 26	7	28	20	57,5	10	2
D702 15	D702 27	7	40	20	70	10	2
D702 16	D702 28	8	28	20	57,5	10	2
D702 17	D702 29	8	40	20	70	10	2
D702 18	D702 30	10	28	20	57,5	10	2
D702 19	D702 31	10	40	20	70	10	2
D702 20	D702 32	12	28	20	57,5	10	2
D702 21	D702 33	12	40	20	70	10	2

Punta foratrice in diamante ad alto rendimento Z2 per fori passanti, ottima per eseguire fori passanti su pannelli truciolari, rivestiti, laminati, nobilitati, MDF

Broca de diamante Z2 de elevado rendimiento para taladrar agujeros pasantes. Es ideal para realizar agujeros pasantes en paneles de aglomerado, melamina, MDF, revestidos y laminados.

DP through hole drilling bit with high performance Z2. Suitable for through hole on laminated chipboard panels MDF.

Mèche à percer en diamant à haut rendement, Z2, optimale pour exécuter des trous passants sur panneaux agglomérés, revêtus, laminés, anoblis, MDF.

Hochleistungs-Diamant-Bohrspitze Z2 für Durchgangslöcher, ideal für Spanplatten, beschichtete, laminierte, veredelte und MDF-Platten.

Алмазная высокопроизводительная фреза-сверло, Z2 для сквозных отверстий, отличная для выборки сквозных отверстий панелей ДСП, ламинированных, меламиновых, шпонируемых, МДФ панелей.

# Art. D703

## punta in diamante foratrice per fori ciechi Z2 corpo in HW

Section INDEX

diamond drill bit Z2 for blind holes, HW body

Bohrspitze für Blindlöcher Z2, Körper aus HW

broca Z2 para taladrar agujeros ciegos con cuerpo en HW

mèche à percer pour trous borgnes Z2 corps en HW

Алмазная фреза Z2 для глухих отверстий, корпус из HW

INDEX by article

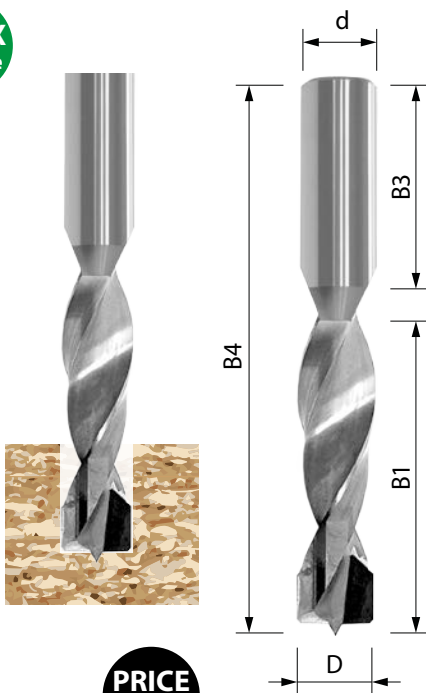

PRICE LIST

Cod. DX / RH	Cod. SX / LH	D mm	B1 mm	B3 mm	B4 mm	d mm	Z tot
D703 10	D703 22	5	28	20	57,5	10	2
D703 11	D703 23	5	40	20	70	10	2
D703 12	D703 24	6	28	20	57,5	10	2
D703 13	D703 25	6	40	20	70	10	2
D703 14	D703 26	7	28	20	57,5	10	2
D703 15	D703 27	7	40	20	70	10	2
D703 16	D703 28	8	28	20	57,5	10	2
D703 17	D703 29	8	40	20	70	10	2
D703 18	D703 30	10	28	20	57,5	10	2
D703 19	D703 31	10	40	20	70	10	2
D703 20	D703 32	12	28	20	57,5	10	2
D703 21	D703 33	12	40	20	70	10	2

Punta foratrice in diamante ad alto rendimento Z2 per fori ciechi, ottima per eseguire fori su pannelli truciolari, rivestiti, laminati, nobilitati, MDF.

DP blind holes drilling bit with high performance Z2. Suitable for drilling on laminated chipboard panels MDF.

Hochleistungs-Diamant-Bohrspitze Z2 für Blindlöcher, ideal für Spanplatten, beschichtete, laminierte, veredelte und MDF-Platten.

Broca de diamante Z2 de elevado rendimiento para taladrar agujeros ciegos. Es ideal para realizar agujeros en paneles de aglomerado, melamina, MDF, revestidos y laminados.

Mèche à percer en diamant à haut rendement, Z2, pour trous borgnes, optimale pour exécuter des trous sur panneaux agglomérés, revêtus, laminés, anoblis, MDF.

Алмазная высокопроизводительная фреза-сверло, Z2 для глухих отверстий, отличная для глухих отверстий панелей ДСП, ламинированных, меламиновых, шпонированных, МДФ панелей.

# Art. D705

## punta in diamante foratrice per fori ciechi Z2+2 con rompitrucolo corpo in acciaio

diamond drill bit Z2+2 for blind holes, with chip-breaker, steel body

Bohrspitze für Blindlöcher Z2+2 mit Spanbrecher, Körper aus HW

broca Z2+2 para taladrar agujeros ciegos con rompitrucos y cuerpo en acero

mèche à percer pour trous borgnes Z2+2 avec brise copeaux corps en acier

Алмазная фреза Z2+2 для глухих отверстий, корпус из стали

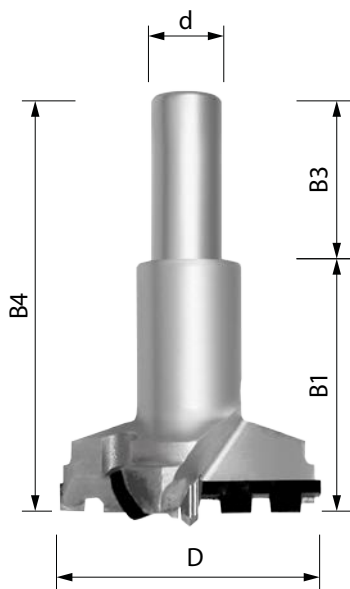

PRICE LIST

Cod. DX / RH	Cod. SX / LH	D mm	B1 mm	B3 mm	B4 mm	d mm	Z tot
D705 10	D705 24	20	28	25	57,5	10	2+2
D705 11	D705 25	20	40	25	70	10	2+2
D705 12	D705 26	22	28	25	57,5	10	2+2
D705 13	D705 27	22	40	25	70	10	2+2
D705 14	D705 28	25	28	25	57,5	10	2+2
D705 15	D705 29	25	40	25	70	10	2+2
D705 16	D705 30	26	28	25	57,5	10	2+2
D705 17	D705 31	26	40	25	70	10	2+2
D705 18	D705 32	30	28	25	57,5	10	2+2
D705 19	D705 33	30	40	25	70	10	2+2
D705 20	D705 34	35	28	25	57,5	10	2+2
D705 21	D705 35	35	40	25	70	10	2+2
D705 22	D705 36	40	28	25	57,5	10	2+2
D705 23	D705 37	40	40	25	70	10	2+2

Punta foratrice in diamante ad alto rendimento Z2+2 per fori ciechi con rasanti negativi e placchette rompitrucolo. Ottima per eseguire fori passanti su pannelli truciolari, rivestiti, laminati, nobilitati, MDF.

DP high performance blind holes drilling bit Z2+2 with negative shaver tips and chip breaker. Suitable for drilling on laminated chipboard panels MDF.

Hochleistungs-Diamant-Bohrspitze Z2+2 für Blindlöcher, mit negativen Vorschneidern und Spanbrechern. Ideal für Spanplatten, beschichtete, laminierte, veredelte und MDF-Platten.

Broca de diamante Z2+2 de elevado rendimiento para taladrar agujeros ciegos con fresas rasantes con ángulo de corte negativo y plaquitas rompitrucos. Es ideal para realizar agujeros pasantes en paneles de aglomerado, melamina, MDF, revestidos y laminados.

Mèche à percer en diamant à haut rendement, Z2+2, pour trous borgnes avec araseurs négatifs et plaquettes brise copeaux. Optimale pour exécuter des trous borgnes sur panneaux agglomérés, revêtus, laminés, anoblis, MDF.

Алмазная высокопроизводительная фреза-сверло, Z2+2 для глухих отверстий с отрицательными ножами и стружколомающими пластинами, отличная для глухих отверстий панелей ДСП, ламинированных, меламиновых, шпонированных, МДФ панелей.



diamond drill bit Z2+2 for through holes, steel body

Bohrspitze für Durchgangslöcher Z2+2, Körper aus Stahl

broca Z2+2 para taladrar agujeros pasantes con cuerpo en acero

mèche à percer pour trous passants Z2+2 corps en acier

Алмазная фреза Z2+2 для сквозных отверстий, корпус из стали

Section INDEX

INDEX by article

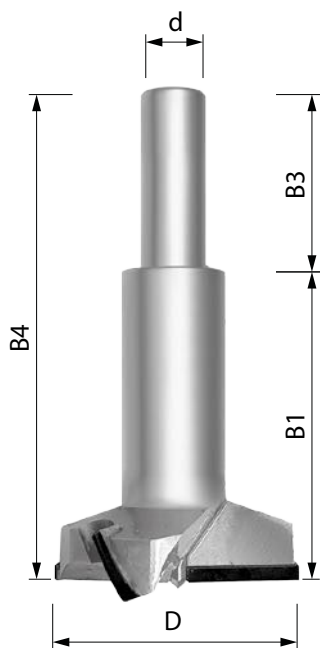

PRICE LIST



Cod. DX / RH	Cod. SX / LH	D mm	B1 mm	B3 mm	B4 mm	d mm	Z tot
D704 10	D704 34	12	28	25	57,5	10	2+2
D704 11	D704 35	12	40	25	70	10	2+2
D704 12	D704 36	14	28	25	57,5	10	2+2
D704 13	D704 37	14	40	25	70	10	2+2
D704 14	D704 38	15	28	25	57,5	10	2+2
D704 15	D704 39	15	40	25	70	10	2+2
D704 16	D704 40	16	28	25	57,5	10	2+2
D704 17	D704 41	16	40	25	70	10	2+2
D704 18	D704 42	18	28	25	57,5	10	2+2
D704 19	D704 43	18	40	25	70	10	2+2
D704 20	D704 44	20	28	25	57,5	10	2+2
D704 21	D704 45	20	40	25	70	10	2+2
D704 22	D704 46	22	28	25	57,5	10	2+2
D704 23	D704 47	22	40	25	70	10	2+2
D704 24	D704 48	25	28	25	57,5	10	2+2
D704 25	D704 49	25	40	25	70	10	2+2
D704 26	D704 50	26	28	25	57,5	10	2+2
D704 27	D704 51	26	40	25	70	10	2+2
D704 28	D704 52	30	28	25	57,5	10	2+2
D704 29	D704 53	30	40	25	70	10	2+2
D704 30	D704 54	35	28	25	57,5	10	2+2
D704 31	D704 55	35	40	25	70	10	2+2
D704 32	D704 56	40	28	25	57,5	10	2+2
D704 33	D704 57	40	40	25	70	10	2+2

Punta foratrice in diamante ad alto rendimento Z2+2 per fori ciechi con rasanti negativi. Ottima per eseguire fori su pannelli truciolari, rivestiti, laminati, nobilitati, MDF.

DP high performance blind holes drilling bit Z2+2 with negative shaver tips. Suitable for drilling on laminated chipboard panels MDF.

Hochleistungs-Diamant-Bohrspitze Z2+2 für Blindlöcher, mit negativen Vorschneidern. Ideal für Spanplatten, beschichtete, laminierte, veredelte und MDF-Platten.

Broca de diamante Z2+2 de elevado rendimiento para taladrar agujeros ciegos con fresas rasantes con ángulo de corte negativo. Es ideal para realizar agujeros en paneles de aglomerado, melamina, MDF, revestidos y laminados.

Mèche à percer en diamant à haut rendement, Z2+2, pour trous borgnes avec araseurs négatifs. Optimale pour exécuter des trous sur panneaux agglomérés, revêtus, laminés, anoblis, MDF.

Алмазная высокопроизводительная фреза-сверло, Z2+2 для глухих отверстий с отрицательными ножами. Отличная для отверстий панелей ДСП, ламинированных, меламиновых, шпонируемых, МФД панелей.

## **FRESE IN DIAMANTE PROFILATE**

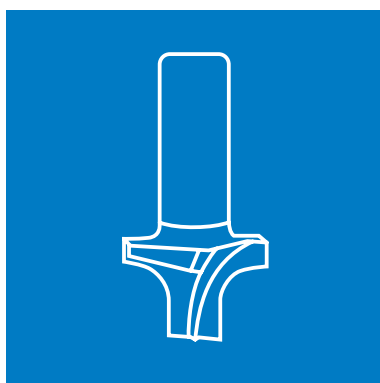

**DIAMOND TOOLS PROFILED**

**PROFILDIAMANTFRÄSER**

**FRESAS EN DIAMANTE PERFILADAS**

**FRAISE EN DIAMANT PROFILEES**

**ПРОФИЛИРОВАННЫЕ АЛМАЗНЫЕ ФРЕЗЫ**



# frese in diamante profilate

diamond tools profiled

Profildiamantfräser

Fresas en diamante perfiladas

FRAISE EN DIAMANT PROFILEES

профилированные алмазные фрезы

Section  
INDEX

INDEX  
by article

**Art. D261**

pag.  
65



**Art. D7A**

pag.  
68



**Art. D11A**

pag.  
76



**Art. D275**

pag.  
66



**Art. D7B**

pag.  
70



**Art. D11B**

pag.  
78



**Art. D276**

pag.  
66



**Art. D7C**

pag.  
72



**Art. D11C**

pag.  
80



**Art. D308**

pag.  
67



**Art. D7D**

pag.  
74



**Art. D11D**

pag.  
82





# Art. D261

## Fresa in diamante per nesting con raggio DP H3.5mm

Section INDEX

DP diamond radius cutter for nesting, H3.5mm

Diamantfräser für Nesting mit Radius PKD H 3,5 mm

Fresa de diamante para nesting con radio y plaquita en DP de H 3,5 mm

Fraises en diamant pour nesting avec rayon, DP H3,5 mm

Алмазная радиусная фреза для nesting DP H3.5mm

INDEX by article

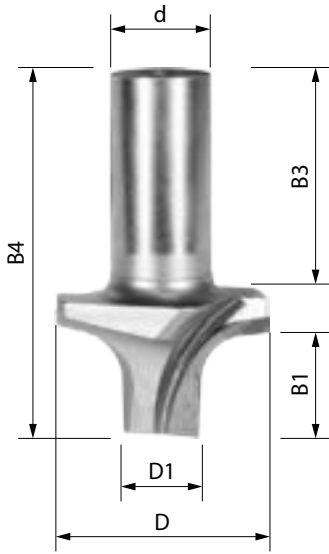

PRICE LIST

NESTING

ANGOLO ASSIALE AXIAL ANGLE

5°

POSITIV

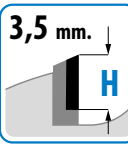

FORANTE / DRILL



Cod.	D mm	D1 mm	R mm	B1 mm	B3 mm	B4 mm	d mm	Z tot	rpm max
D261 10	18	12	1	16	50	80	20	2+1	24000
D261 11	20	12	2	16	50	80	20	2+1	24000
D261 12	22	12	3	16	50	80	20	2+1	24000
D261 13	24	12	4	16	50	80	20	2+1	24000
D261 14	26	12	5	16	50	80	20	2+1	24000
D261 15	30	12	6	16	50	80	20	2+1	24000
D261 16	18	12	1	18	50	80	20	2+1	24000
D261 17	20	12	2	18	50	80	20	2+1	24000
D261 18	22	12	3	18	50	80	20	2+1	24000
D261 19	24	12	4	18	50	80	20	2+1	24000
D261 20	26	12	5	18	50	80	20	2+1	24000
D261 21	30	12	6	18	50	80	20	2+1	24000
D261 22	18	12	1	22	50	80	20	2+1	24000
D261 23	20	12	2	22	50	80	20	2+1	24000
D261 24	22	12	3	22	50	80	20	2+1	24000
D261 25	24	12	4	22	50	80	20	2+1	24000
D261 26	26	12	5	22	50	80	20	2+1	24000
D261 27	30	12	6	22	50	80	20	2+1	24000

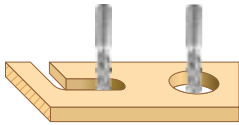

🇮🇹 Fresa in diamante per nesting con raggio DP H3.5mm per lavorazioni di antine da cucina, pannelli MDF raggiati. Si costruiscono in 3 diverse altezze 16, 18 e 22 con forante in DP, angolo assiale positivo

🇪🇸 Fresa de diamante para nesting con radio y plaquita en DP de H 3,5 mm para mecanizar las puertas de los muebles de cocina y paneles en MDF radiados. Se encuentra disponible en tres alturas diferentes (16, 18 y 22) con broca para taladrar en DP y ángulo axial positivo

🇬🇧 DP diamond radius cutter for nesting, H3.5mm, for machining operations on radiused MDF kitchen cabinet doors. Made in 3 different heights, 16, 18 and 22, with DP drill, positive axial angle

🇫🇷 Fraises en diamant pour nesting avec rayon, DP H3,5 mm pour l'usinage de porte de cuisine, panneaux MDF avec rayon. Elles se construisent en 3 hauteurs différentes 16, 18 et 22 avec perceur en DP, angle axial positif.

🇩🇪 Diamantfräser für Nesting mit Radius PKD H 3,5 mm für Bearbeitungen von Küchenfronten und abgerundeten MDF-Platten, Sie werden in 3 verschiedenen Höhen 16, 18 und 22 mit Einbohrschneide in PKD und positivem Achswinkel hergestellt

🇷🇺 Алмазная радиусная фреза для nesting DP H3.5mm для округлений кухонных створок из MDF панелей. Конструкция предусматривает 3 разных высоты 16, 18 и 22; сверло из DP, осевой угол положительный

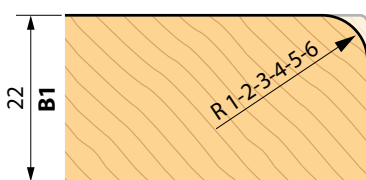
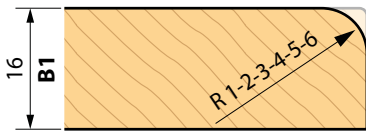

# Art. D275

## Fresa in diamante per folding a 45° DP H4.5mm

DP diamond cutter for 45° folding, H4.5mm

Diamantfräser für Folding 45° PKD H 4,5 mm

Fresa de diamante a 45° para folding con plaquita en DP de H 4,5 mm

Fraise en diamant pour folding à 45°, DP H4,5 mm

Алмазная фреза для folding под 45° DP H4.5mm

Section INDEX

INDEX by article

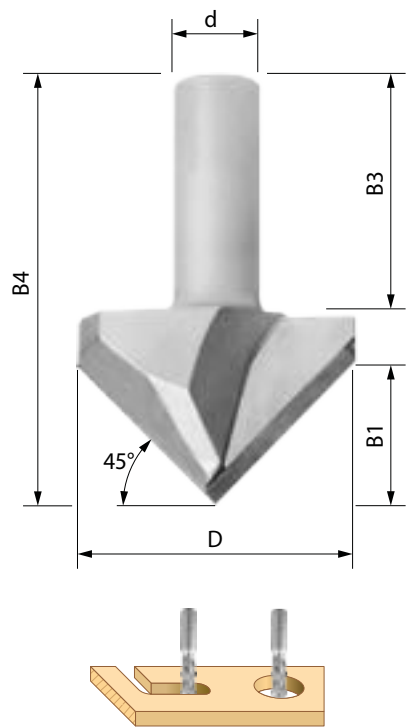

ANGOLO ASSIALE AXIAL ANGLE

0°

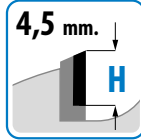

PRICE LIST

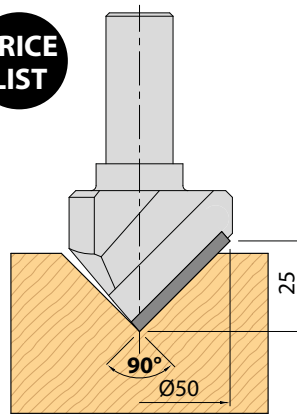

Cod.	D mm	B1 mm	B3 mm	B4 mm	d mm	Z tot	rpm max
D275 10	50	25	50	90	20	2	24000
D275 11	70	35	50	90	20	2	24000

Costruita in Z=2, corpo in acciaio speciale DP H4.5mm a 45° per lavorazioni su pannelli composti legno ed altri materiali/

Fresa Z=2 con cuerpo de acero especial y plaquita en DP de H 4,5 mm a 45° para mecanizar paneles compuestos de madera y otros materiales

Manufactured from DP diamond, H4.5mm, Z=2 with special steel body for kerfing cuts on panels of wood composite and other materials folded to 45°

Construite en Z2, corps en acier spécial, DP H4,5 mm, 45°, pour l'usage sur panneaux composés de bois et autre matériel.

Hergestellt in Z=2, Körper aus Sonderstahl PKD H 4,5 mm bei 45° für Bearbeitungen von Verbundplatten aus Holz und anderen Materialien

Произведена с Z=2, корпус из специальной стали DP H4.5mm под 45° для обработок смешанных панелей из дерева и других материалов

# Art. D276

## Fresa in diamante per folding DP H4mm

DP diamond cutter for folding, H4mm

Diamantfräser für Folding PKD H 4 mm

Fresa de diamante para folding con plaquita en DP de H 4 mm

Fraises en diamant pour folding, DP H4 mm

Алмазная фреза для folding DP H4mm

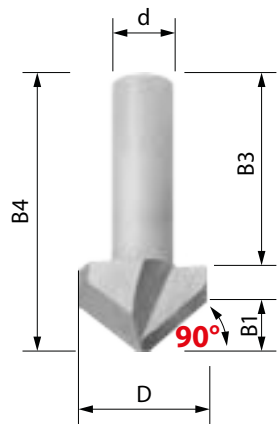

ANGOLO ASSIALE AXIAL ANGLE

5°

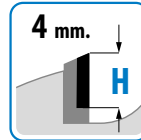

PRICE LIST

Cod.	α	D mm	B1 mm	B3 mm	B4 mm	d mm	Z tot	rpm max
D276 10	90°	20	13	50	70	16	1	24000
D276 11	135°	35	20	50	70	16	1	24000

Costruite in diamante DP H4mm Z=1 per lavorazioni di folding su pannelli composti in alluminio Alucobond, Dibond, per piegature a 90° e 135° per facciate ventilate

Manufactured from DP diamond, H4mm, Z=1 for kerfing cuts on Alucobond, Dibond, and similar aluminium composite panels folded to 90° and 135° used on ventilated façades

Hergestellt aus Diamant PKD H 4 mm Z=1 für Folding-Bearbeitungen an Aluminium-verbundplatten Alucobond und Dibond, zum 90° und 135° Biegen für hinterlüftete Fassaden

Fresa de diamante Z=1 con plaquita en DP de H 4 mm para folding en paneles compuestos de aluminio Alucobond, Dibond así como para plegado a 90° y 135° de fachadas ventiladas.

Réalisées en diamant, DP H4 mm Z1 pour l'usage de folding sur panneaux composés d'aluminium Alucobond, Dibond, pour des pliures de 90° et 135°, pour façades ventilées.

Сделана из алмаза DP H4mm Z=1 для обработок folding для панелей из алюминия Alucobond, Dibond, для изгибов на 90° и 135° для вентилированных фасадов

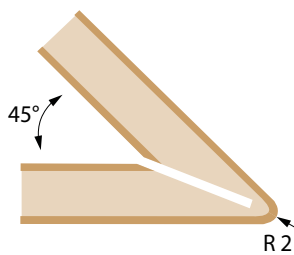
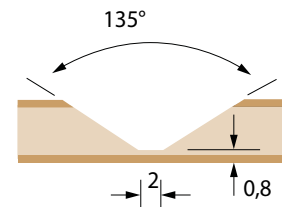
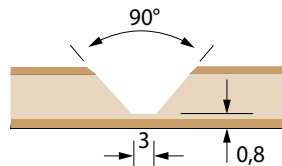

# Art. D308

## fresa in diamante T-SLOT per profili in alluminio Z2+2 corpo in acciaio DP H 4,5 mm

Section INDEX

DP diamond T-SLOT router bit Z2+2 for aluminium profiles, steel body H 4.5 mm

Diamantfräser T-SLOT für Aluminiumprofile Z2+2 mit Körper aus Stahl, PKD H 4,5 mm

fresa de diamante T-SLOT para perfiles en aluminio Z2+2 con cuerpo en acero y plaquita en DP de H 4,5 mm

fraise en diamant T-SLOT pour profils en aluminium Z2+2 corps en acier DP H 4,5 mm

Алмазная фреза под Т-образный паз для алюминиевых профилей Z2+2 корпус из стали

INDEX by article

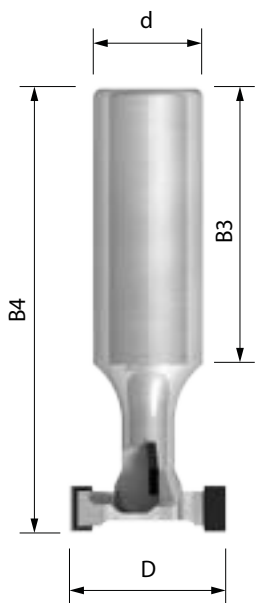

Cod.	D mm	B3 mm	B4 mm	d mm	Z tot	A mm	B mm	C mm	D mm	E mm	R mm	rpm max
D308 10	28,40	50	80	20	4	28,4	8,5	11,4	14,2	16	50°	24000
D308 11	30,50	50	80	20	4	30,5	8,3	11,4	14,1	16	60°	24000

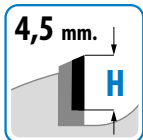

Fresa sagomata in diamante per lavorazione cave per profili di alluminio.

Fresa perfilada de diamante para realizar ranuras en perfiles de aluminio.

Diamond T-SLOT BITS for aluminium profiles.

Fraise profilée en diamant pour l'usinage de rainure de profils en aluminium.

Profilfräser aus Diamant zum Nutfräsen an Aluminiumprofilen.

Фреза алмазная профилированная для обработки выборки профиля из алюминия.

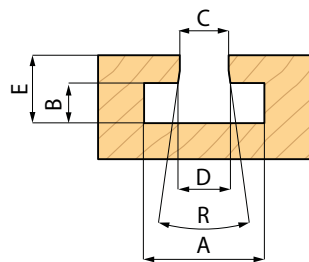

PRICE LIST

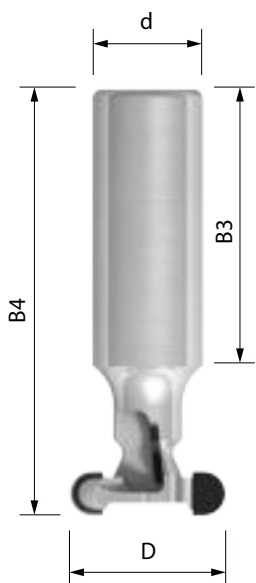

Cod.	D mm	B3 mm	B4 mm	d mm	Z tot	A mm	B mm	C mm	D mm	R1 mm	R2 mm	rpm max
D308 12	28,50	50	80	20	4	28,5	8	14,5	14,1	49,44°	90°	24000

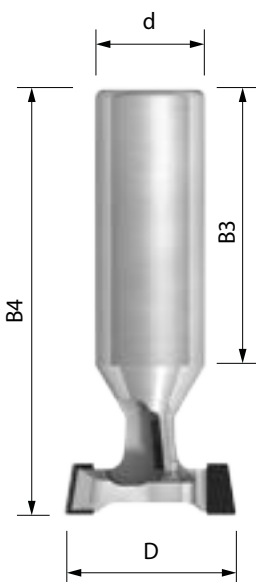
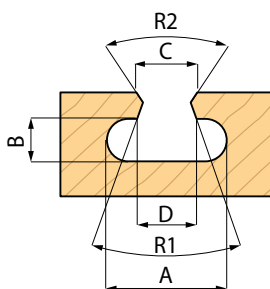

Cod.	D mm	B3 mm	B4 mm	d mm	Z tot	A mm	B mm	C mm	D mm	E mm	F mm	R1 mm	rpm max
D308 13	31,56	50	80	20	4	31,56	9,5	11,8	12,84	19	29,59	15,66°	24000

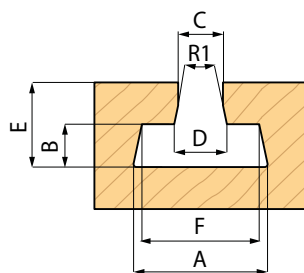

# Art. D7A

confezione di 5 punte in diamante Z2 con corpo in acciaio DP H 4,5 mm

Kit comprising DP diamond tools, H4.5mm

Satz Diamantwerkzeuge PKD H 4,5 mm

Juego de herramientas de diamante con plaquita en DP de H 4,5 mm

Kit d'outils en diamant, DP H4,5 mm

Комплект алмазного инструмента DP H4.5mm

Section INDEX

INDEX by article

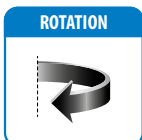
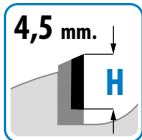

Cod.		ø D mm	B mm	ø d mm	Z	rpm max
D7A 10	1	50	25	20 x 50	2	24000
D7A 11	2	30	20	20 x 50	2	24000
D7A 12	3	25	20	20 x 50	2	24000
D7A 13	4	40	20	20 x 50	2	24000
D7A 14	5	20	20	20 x 50	2	24000
D7A 15	1	50	25	25 x 50	2	24000
D7A 16	2	30	20	25 x 50	2	24000
D7A 17	3	25	20	25 x 50	2	24000
D7A 18	4	40	20	25 x 50	2	24000
D7A 19	5	20	20	25 x 50	2	24000

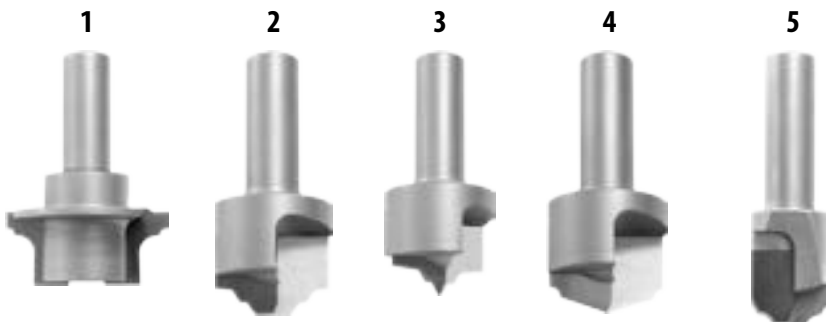

🇮🇹 Kit di utensili in diamante DP H4.5mm con corpo in acciaio speciale per lavorazioni di antine per cucine in MDF

🇬🇧 Kit comprising DP diamond tools, H4.5mm, with special steel body, for machining MDF kitchen cabinet doors

🇩🇪 Satz Diamantwerkzeuge PKD H 4,5 mm mit Körper aus Sonderstahl für Bearbeitungen von Küchenfronten aus MDF

🇪🇸 Juego de herramientas de diamante con plaquita en DP de H 4,5 mm y cuerpo de acero especial para mecanizar las puertas en MDF de los muebles de cocina

🇫🇷 Kit d'outils en diamant, DP H4,5 mm avec corps en acier spécial pour l'usinage de porte de cuisine en MDF.

🇷🇺 Комплект алмазного инструмента DP H4.5mm с корпусом из специальной стали для обработки кухонных створок из MDF

PRICE LIST

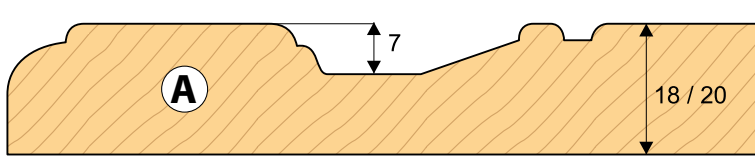
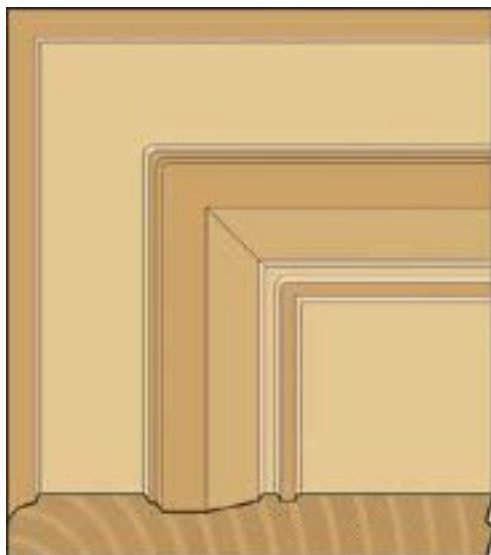

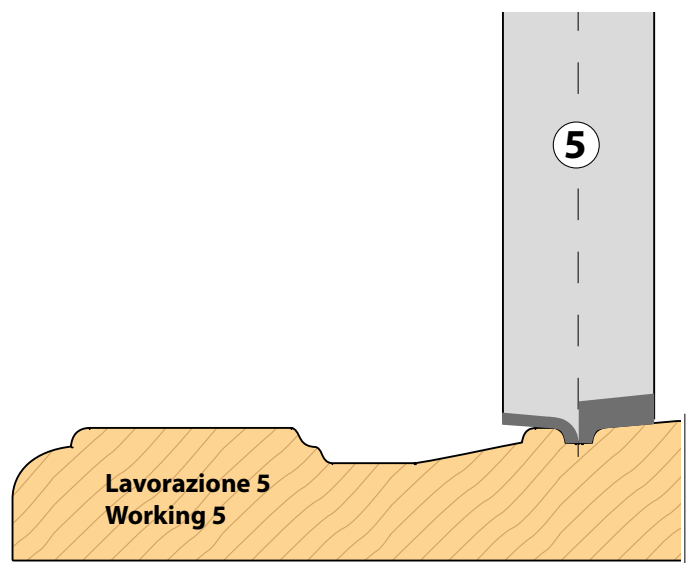
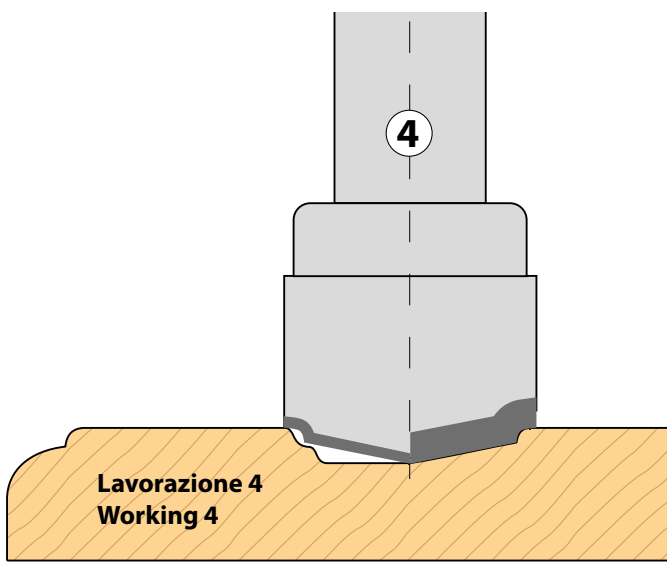
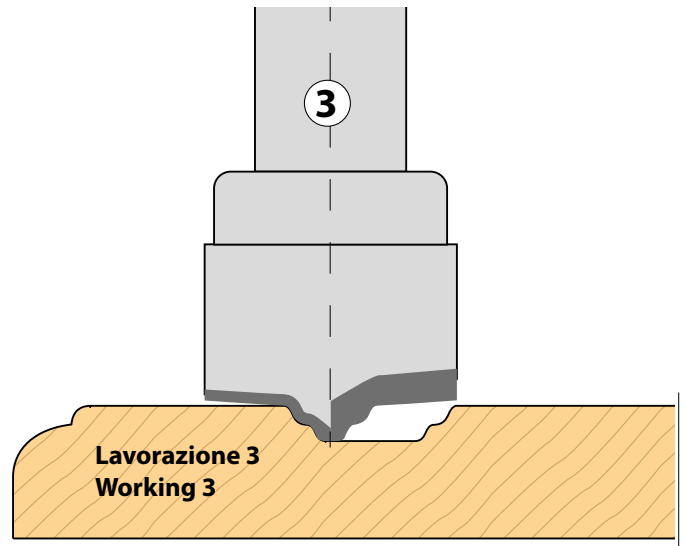
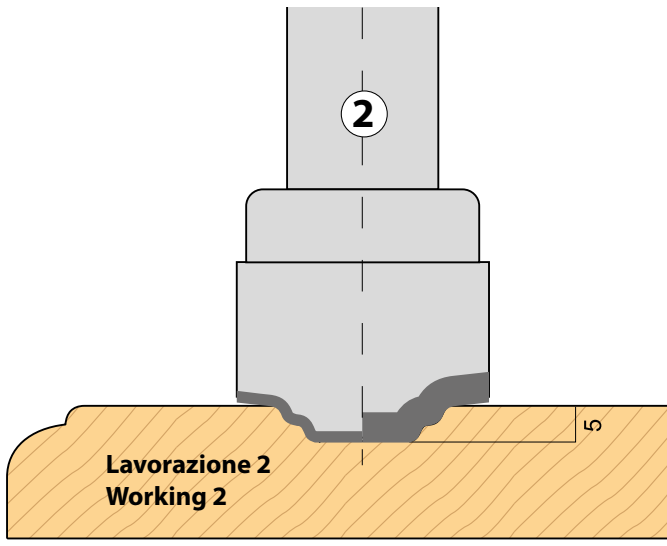
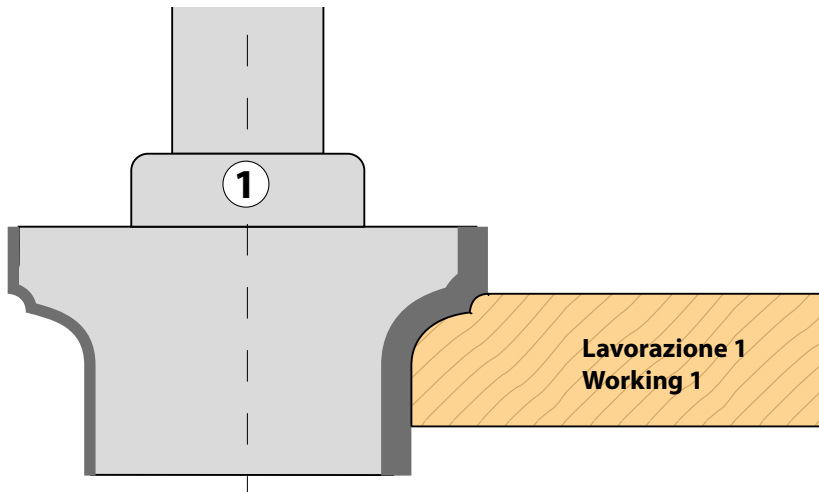

# Art. D7B

confezione di 5 punte in diamante Z2 con corpo in acciaio DP H 4,5 mm

Kit comprising DP diamond tools, H4.5mm

Satz Diamantwerkzeuge PKD H 4,5 mm

Juego de herramientas de diamante con plaquita en DP de H 4,5 mm

Kit d'outils en diamant, DP H4,5 mm

Комплект алмазного инструмента DP H4.5mm

Section INDEX

INDEX by article

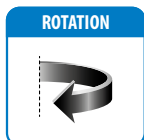
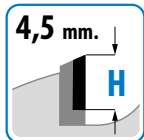

Cod.		ø D mm	B mm	ø d mm	Z	rpm max
D7B 10	1	50	25	20 x 50	2	24000
D7B 11	2	40	20	20 x 50	2	24000
D7B 12	3	25	20	20 x 50	2	24000
D7B 13	4	40	20	20 x 50	2	24000
D7B 14	5	20	20	20 x 50	2	24000
D7B 15	1	50	25	25 x 50	2	24000
D7B 16	2	40	20	25 x 50	2	24000
D7B 17	3	25	20	25 x 50	2	24000
D7B 18	4	40	20	25 x 50	2	24000
D7B 19	5	20	20	25 x 50	2	24000

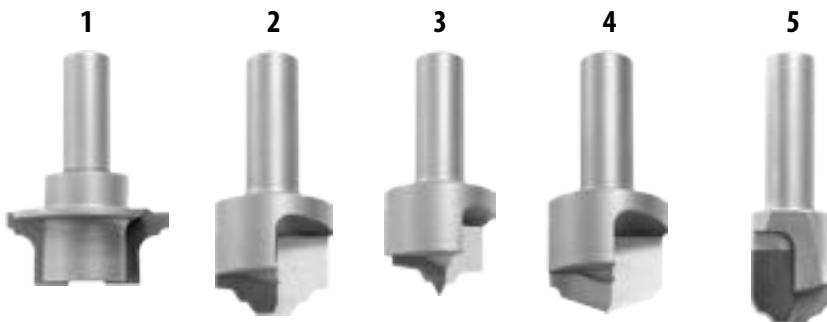

Kit di utensili in diamante DP H4.5mm con corpo in acciaio speciale per lavorazioni di antine per cucine in MDF

Kit comprising DP diamond tools, H4.5mm, with special steel body, for machining MDF kitchen cabinet doors

Satz Diamantwerkzeuge PKD H 4,5 mm mit Körper aus Sonderstahl für Bearbeitungen von Küchenfronten aus MDF

Juego de herramientas de diamante con plaquita en DP de H 4,5 mm y cuerpo de acero especial para mecanizar las puertas en MDF de los muebles de cocina

Kit d'outils en diamant, DP H4,5 mm avec corps en acier spécial pour l'usinage de porte de cuisine en MDF.

Комплект алмазного инструмента DP H4.5mm с корпусом из специальной стали для обработки кухонных створок из MDF

PRICE LIST

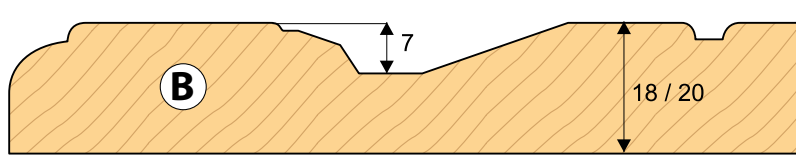

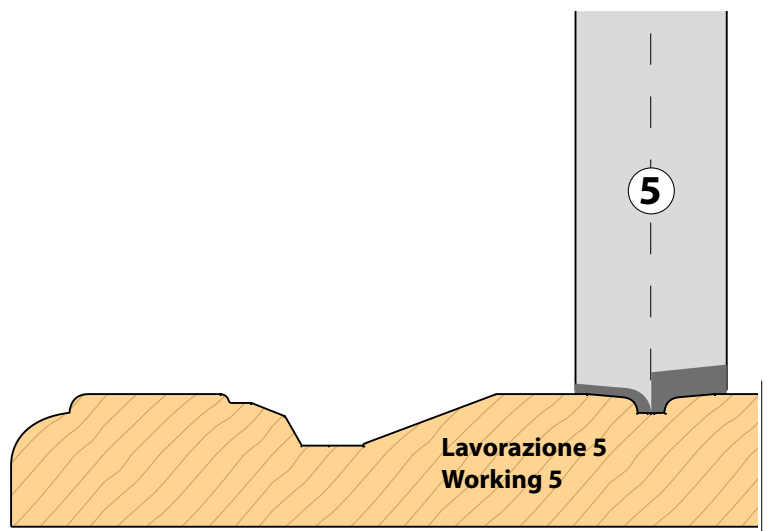
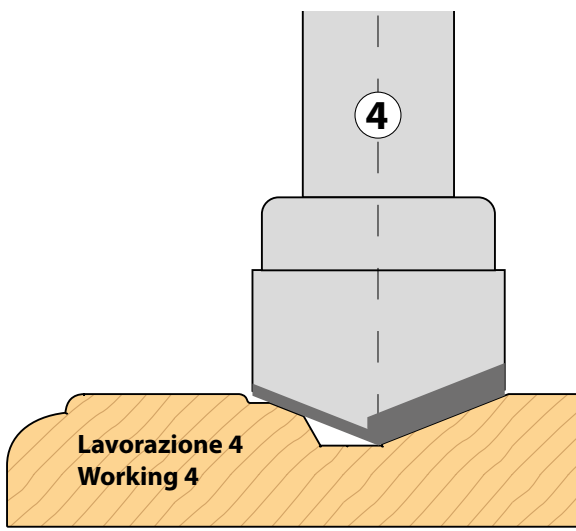
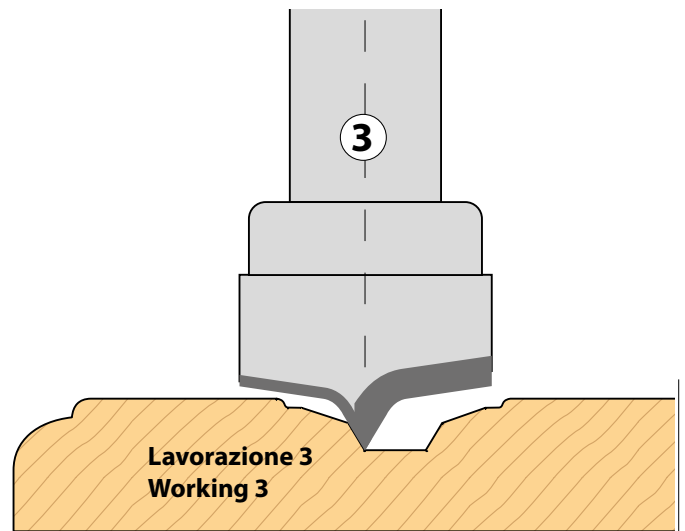
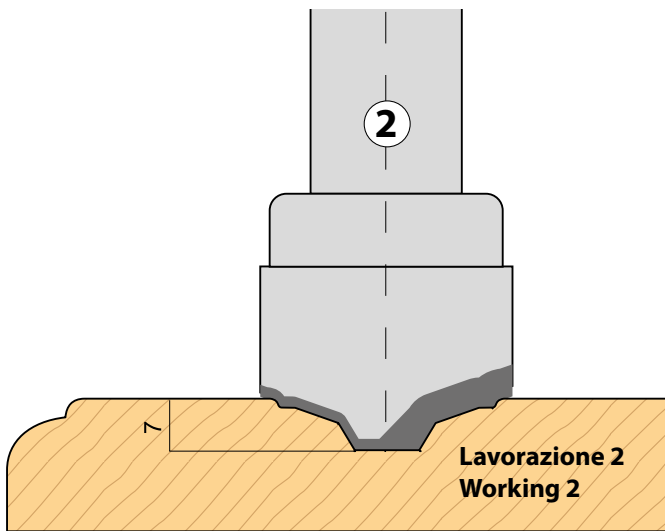
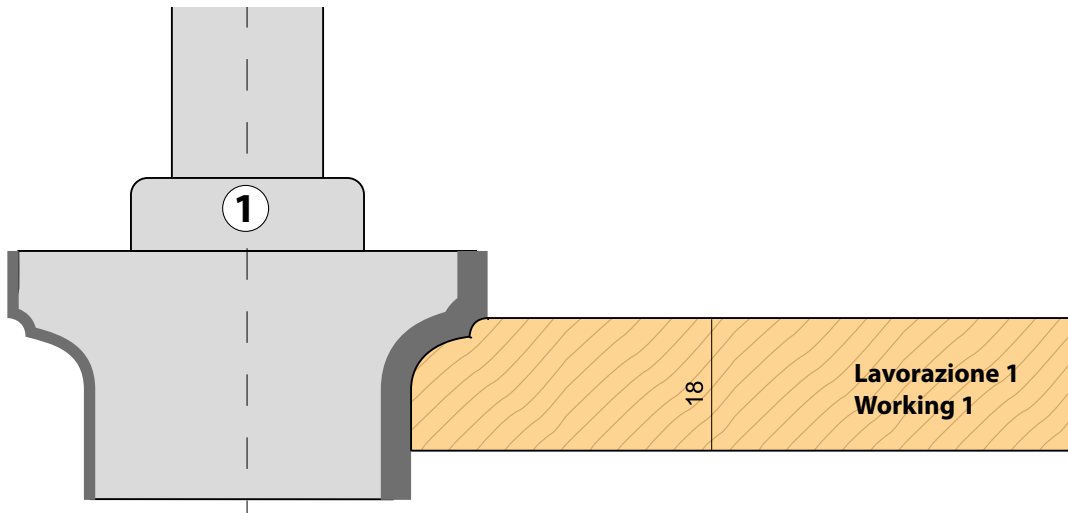

Kit comprising DP diamond tools, H4.5mm

Satz Diamantwerkzeuge PKD H 4,5 mm

Juego de herramientas de diamante con plaquita en DP de H 4,5 mm

Kit d'outils en diamant, DP H4,5 mm

Комплект алмазного инструмента DP H4.5mm

Section INDEX

INDEX by article

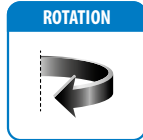
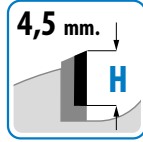

Cod.		ø D mm	B mm	ø d mm	Z	rpm max
D7C 10	1	50	25	20 x 50	2	24000
D7C 11	2	20	20	20 x 50	2	24000
D7C 12	3	20	20	20 x 50	2	24000
D7C 13	4	30	25	20 x 50	2	24000
D7C 14	5	40	25	20 x 50	2	24000
D7C 15	1	50	25	25 x 50	2	24000
D7C 16	2	20	20	25 x 50	2	24000
D7C 17	3	20	20	25 x 50	2	24000
D7C 18	4	30	25	25 x 50	2	24000
D7C 19	5	40	25	25 x 50	2	24000

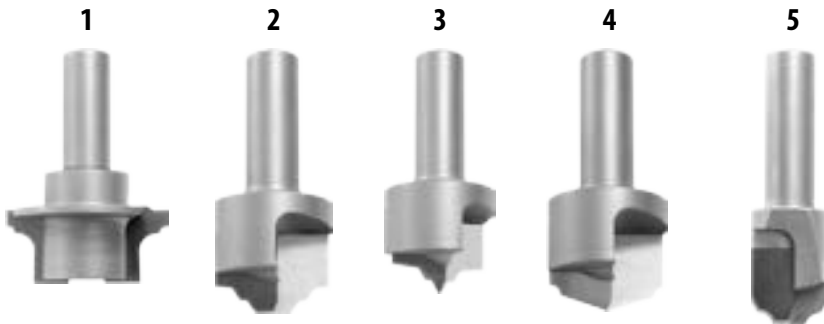

🇮🇹 Kit di utensili in diamante DP H4.5mm con corpo in acciaio speciale per lavorazioni di antine per cucine in MDF

🇬🇧 Kit comprising DP diamond tools, H4.5mm, with special steel body, for machining MDF kitchen cabinet doors

🇩🇪 Satz Diamantwerkzeuge PKD H 4,5 mm mit Körper aus Sonderstahl für Bearbeitungen von Küchenfronten aus MDF

🇪🇸 Juego de herramientas de diamante con plaquita en DP de H 4,5 mm y cuerpo de acero especial para mecanizar las puertas en MDF de los muebles de cocina

🇫🇷 Kit d'outils en diamant, DP H4,5 mm avec corps en acier spécial pour l'usinage de porte de cuisine en MDF.

🇷🇺 Комплект алмазного инструмента DP H4.5mm с корпусом из специальной стали для обработки кухонных створок из MDF

PRICE LIST

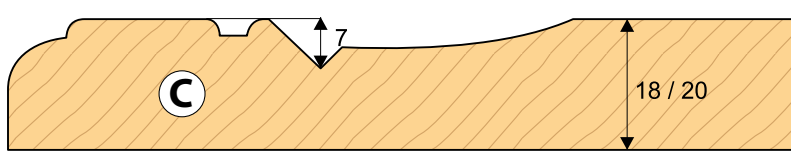



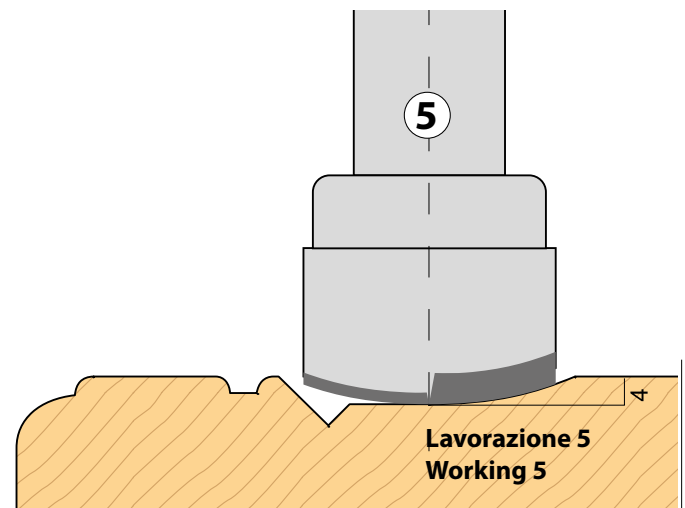
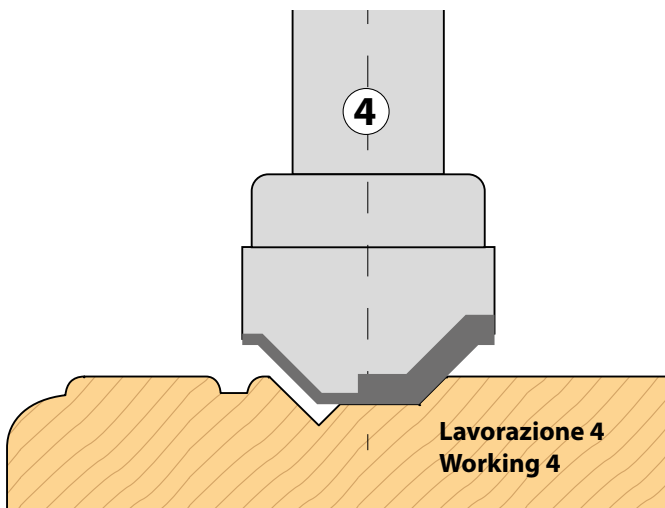
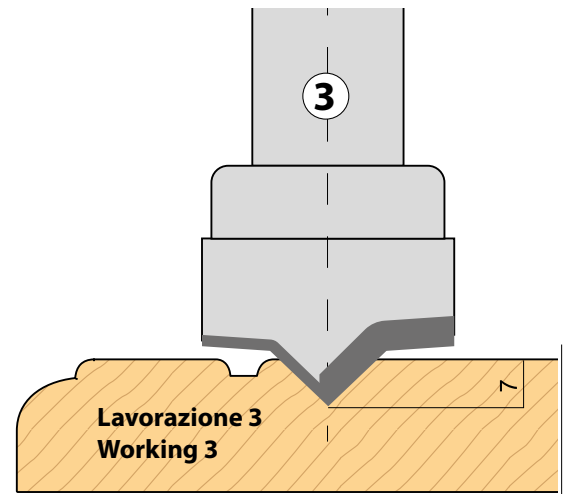
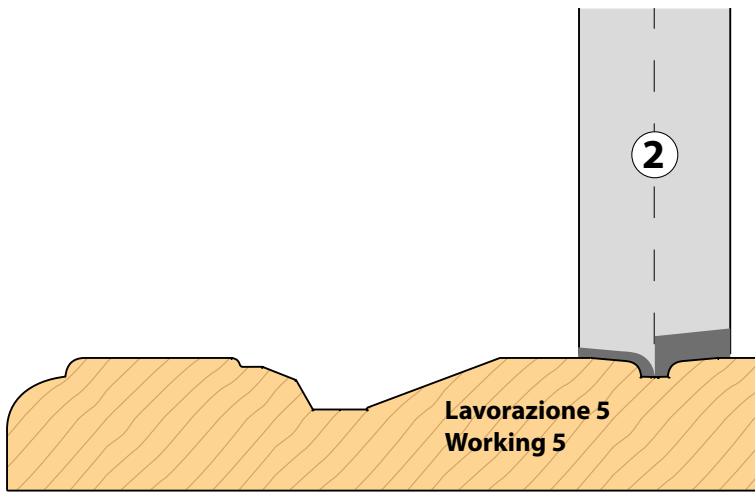
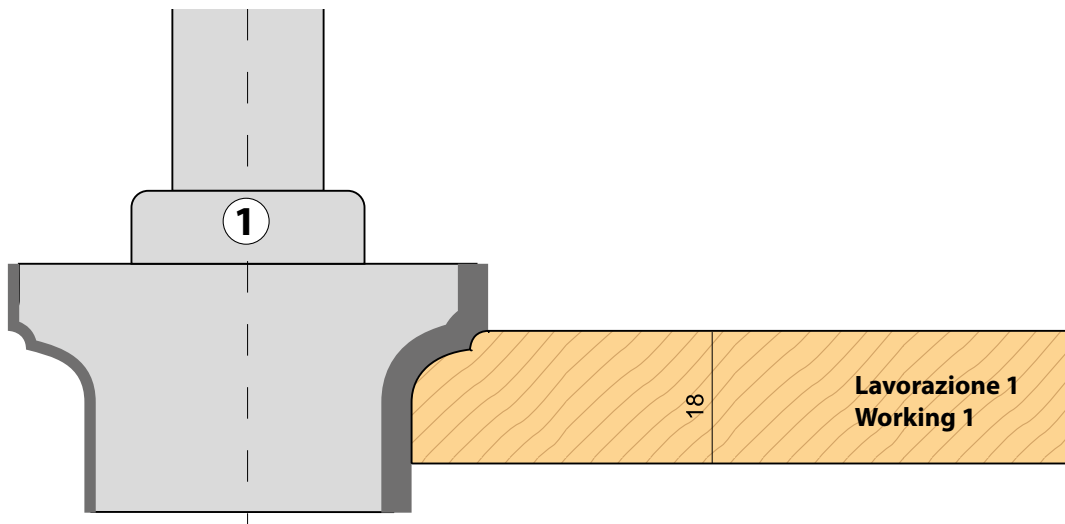

# Art. D7D

confezione di 4 punte in diamante Z2 con corpo in acciaio DP H 4,5 mm

Kit comprising DP diamond tools, H4.5mm

Satz Diamantwerkzeuge PKD H 4,5 mm

Juego de herramientas de diamante con plaquita en DP de H 4,5 mm

Kit d'outils en diamant, DP H4,5 mm

Комплект алмазного инструмента DP H4.5mm

Section INDEX

INDEX by article

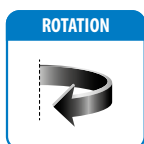
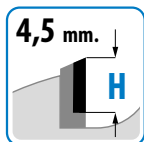

Cod.		ø D mm	B mm	ø d mm	Z	rpm max
D7D 10	1	50	25	20 x 50	2	24000
D7D 11	2	12	20	20 x 50	2	24000
D7D 12	3	40	25	20 x 50	2	24000
D7D 13	4	25	20	20 x 50	2	24000
D7D 14	1	50	25	25 x 50	2	24000
D7D 15	2	12	20	25 x 50	2	24000
D7D 16	3	40	25	25 x 50	2	24000
D7D 17	4	25	20	25 x 50	2	24000

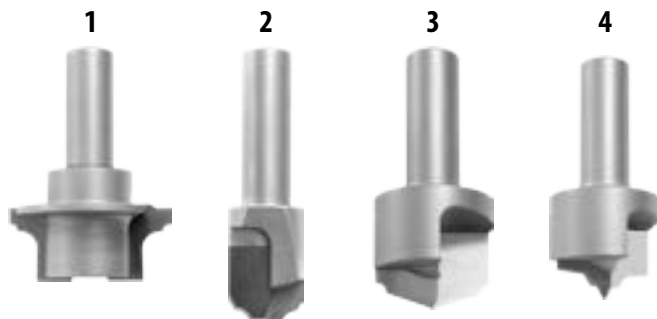

Kit di utensili in diamante DP H4.5mm con corpo in acciaio speciale per lavorazioni di antine per cucine in MDF

Kit comprising DP diamond tools, H4.5mm, with special steel body, for machining MDF kitchen cabinet doors

Satz Diamantwerkzeuge PKD H 4,5 mm mit Körper aus Sonderstahl für Bearbeitungen von Küchenfronten aus MDF

Juego de herramientas de diamante con plaquita en DP de H 4,5 mm y cuerpo de acero especial para mecanizar las puertas en MDF de los muebles de cocina

Kit d'outils en diamant, DP H4,5 mm avec corps en acier spécial pour l'usinage de porte de cuisine en MDF.

Комплект алмазного инструмента DP H4.5mm с корпусом из специальной стали для обработки кухонных створок из MDF

PRICE LIST

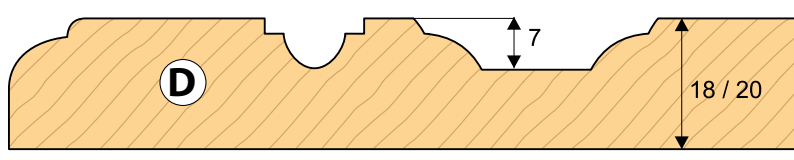
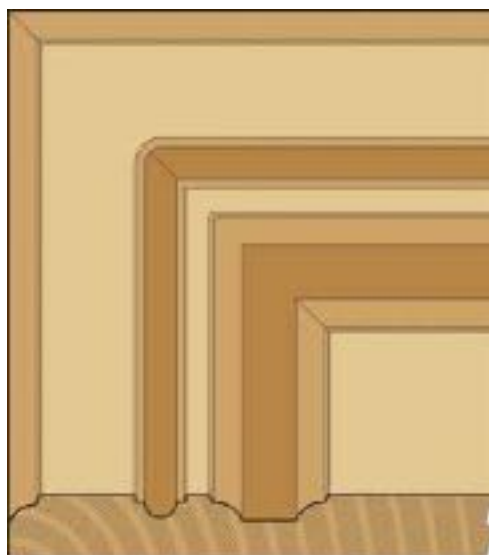

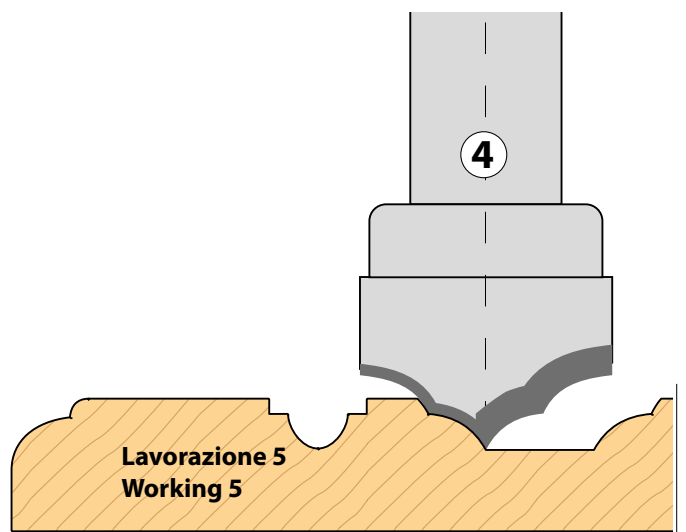
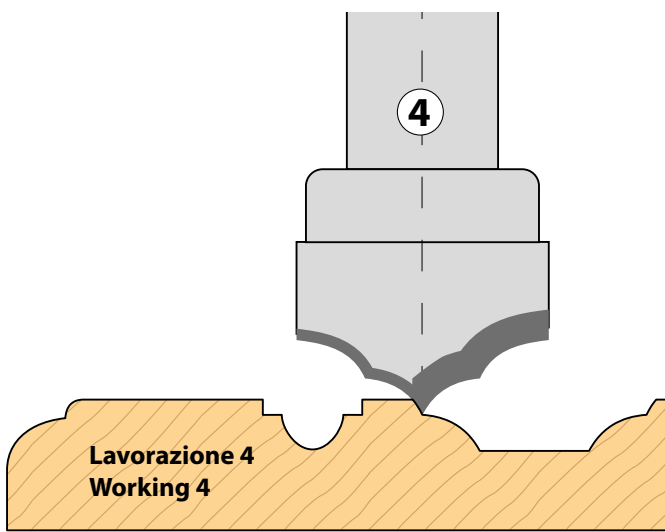
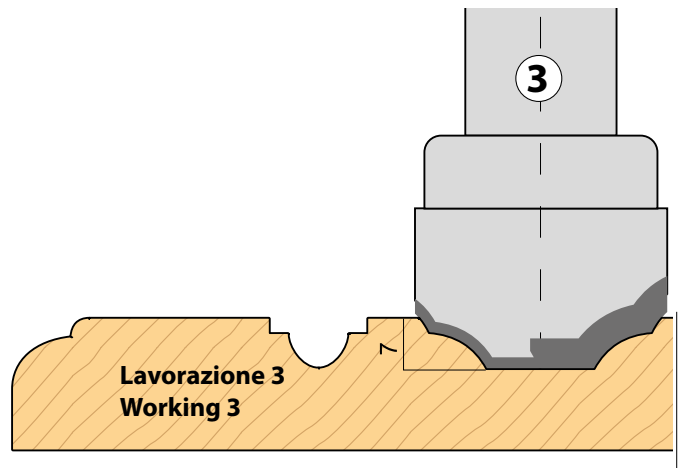
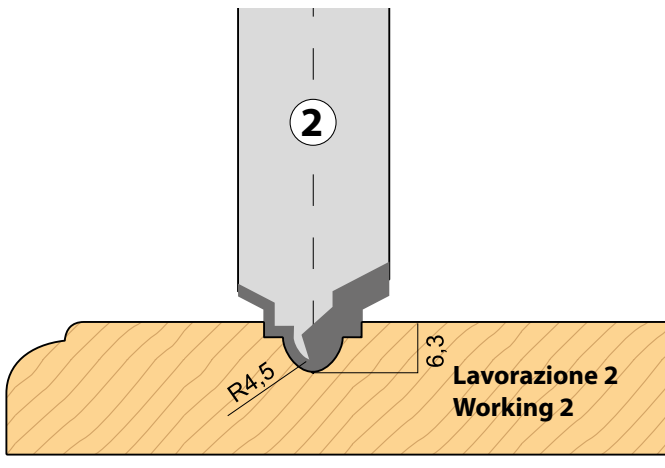
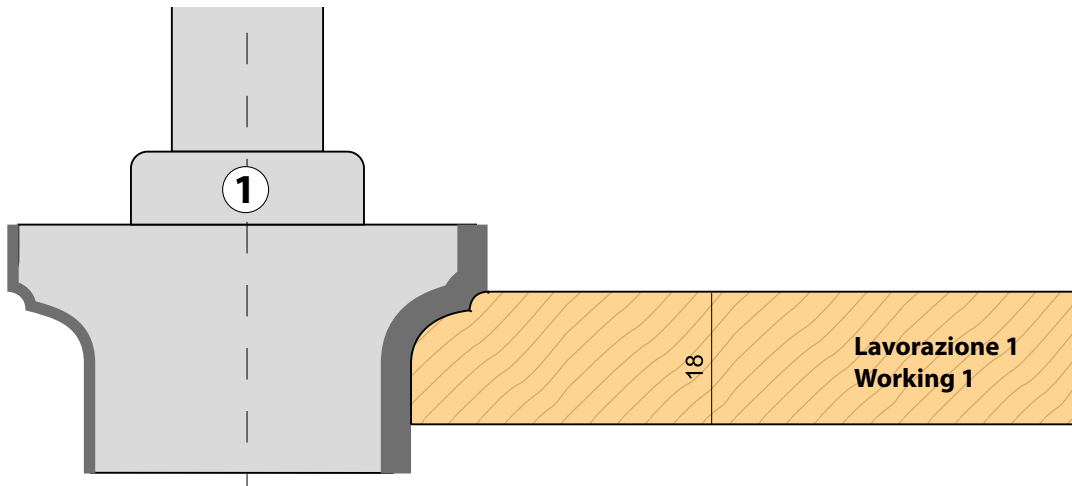

# Art. D11A

confezione di 5 punte in diamante Z2 con corpo in acciaio DP H 4,5 mm

Kit comprising DP diamond tools, H4.5mm

Satz Diamantwerkzeuge PKD H 4,5 mm

Juego de herramientas de diamante con plaquita en DP de H 4,5 mm

Kit d'outils en diamant, DP H4,5 mm

Комплект алмазного инструмента DP H4.5mm

Section INDEX

INDEX by article

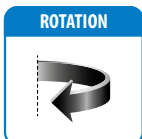
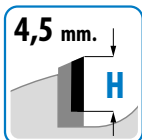

Cod.		ø D mm	B mm	ø d mm	Z	rpm max
D11A 10	1	50	25	20 x 50	2	24000
D11A 11	2	40	25	20 x 50	2	24000
D11A 12	3	30	25	20 x 50	2	24000
D11A 13	4	40	25	20 x 50	2	24000
D11A 14	5	20	20	20 x 50	2	24000
D11A 15	1	50	25	25 x 50	2	24000
D11A 16	2	40	25	25 x 50	2	24000
D11A 17	3	30	25	25 x 50	2	24000
D11A 18	4	40	25	25 x 50	2	24000
D11A 19	5	20	20	25 x 50	2	24000

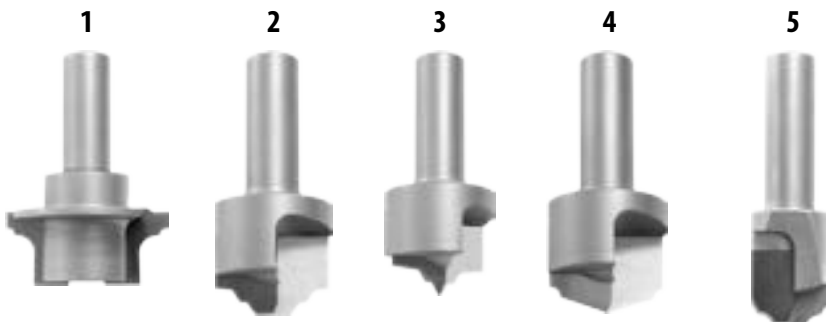

🇮🇹 Kit di utensili in diamante DP H4.5mm con corpo in acciaio speciale per lavorazioni di antine per cucine in MDF

🇬🇧 Kit comprising DP diamond tools, H4.5mm, with special steel body, for machining MDF kitchen cabinet doors

🇩🇪 Satz Diamantwerkzeuge PKD H 4,5 mm mit Körper aus Sonderstahl für Bearbeitungen von Küchenfronten aus MDF

🇪🇸 Juego de herramientas de diamante con plaquita en DP de H 4,5 mm y cuerpo de acero especial para mecanizar las puertas en MDF de los muebles de cocina

🇫🇷 Kit d'outils en diamant, DP H4,5 mm avec corps en acier spécial pour l'usinage de porte de cuisine en MDF.

🇷🇺 Комплект алмазного инструмента DP H4.5mm с корпусом из специальной стали для обработки кухонных створок из MDF

PRICE LIST

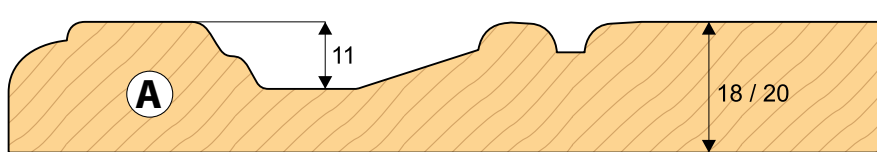
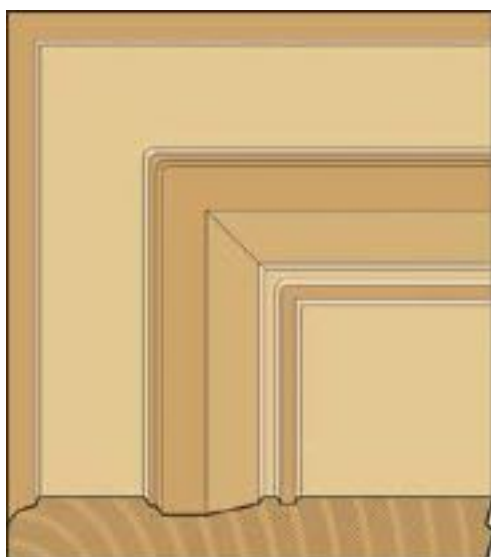

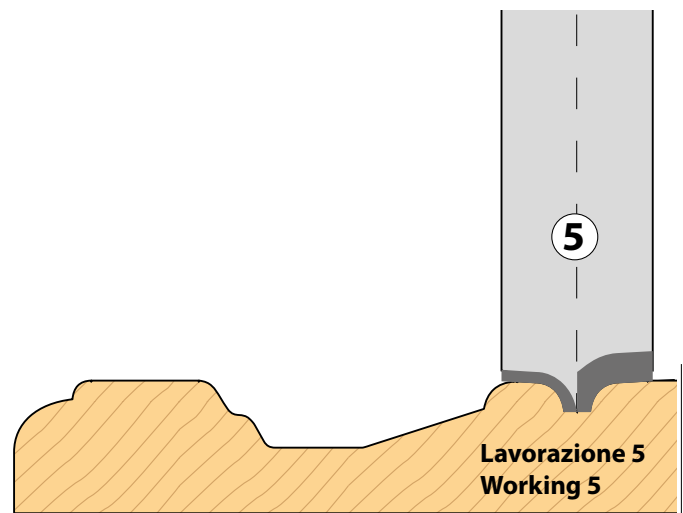
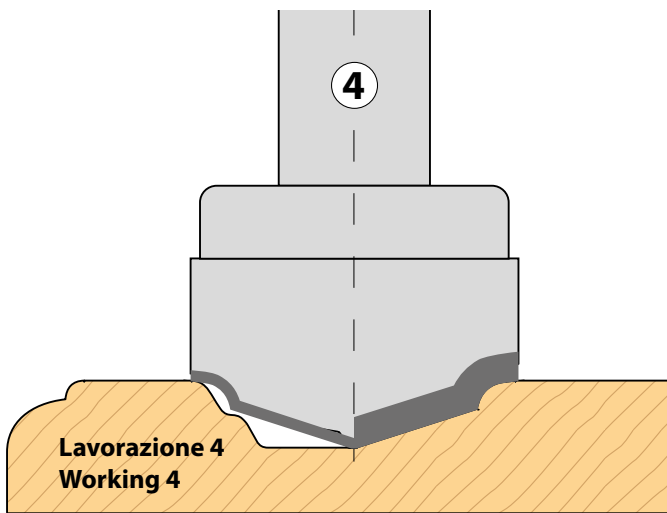
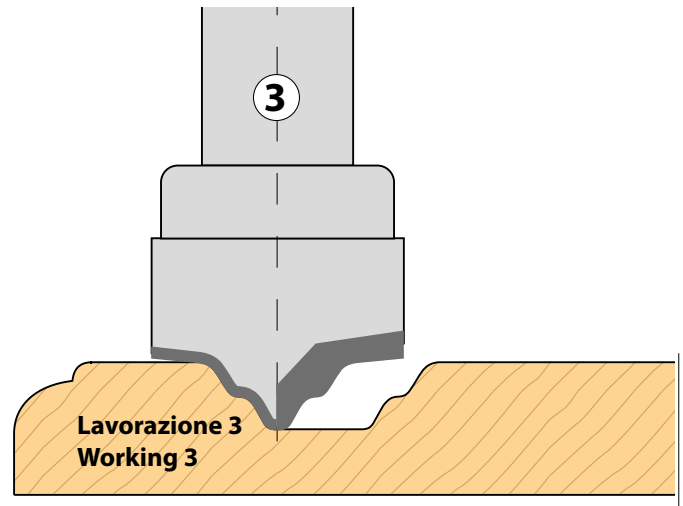
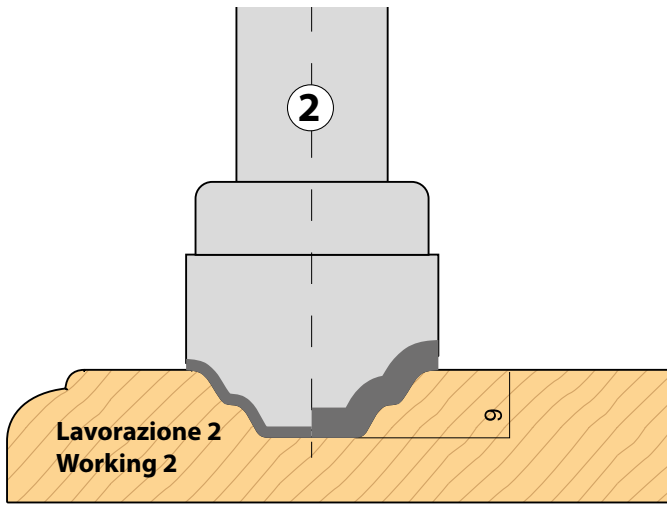
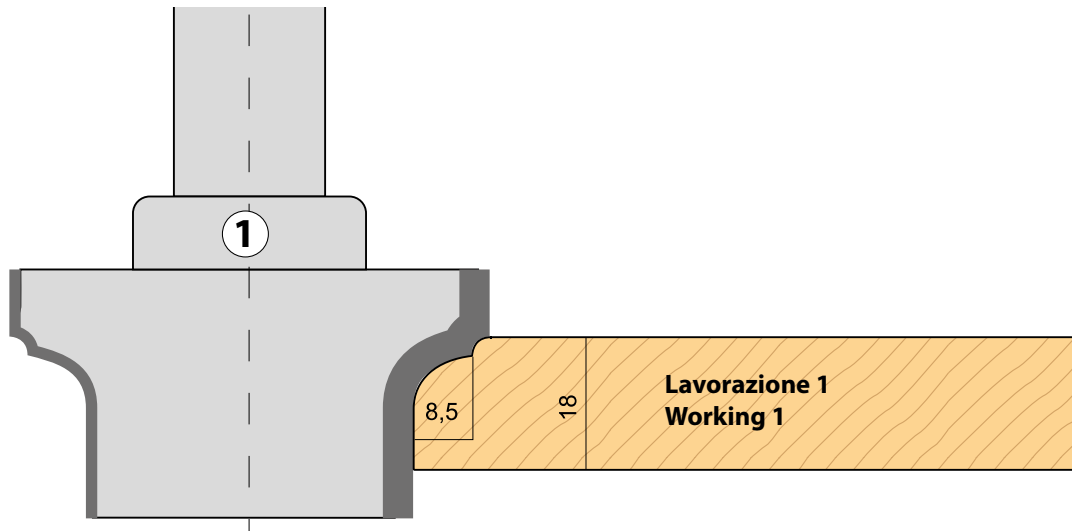

# Art. D11B

confezione di 5 punte in diamante Z2 con corpo in acciaio DP H 4,5 mm

Kit comprising DP diamond tools, H4.5mm

Satz Diamantwerkzeuge PKD H 4,5 mm

Juego de herramientas de diamante con plaquita en DP de H 4,5 mm

Kit d'outils en diamant, DP H4,5 mm

Комплект алмазного инструмента DP H4.5mm

Section INDEX

INDEX by article

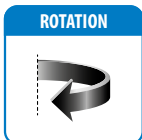
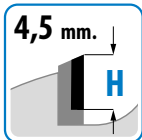

Cod.		ø D mm	B mm	ø d mm	Z	rpm max
D11B 10	1	50	25	20 x 50	2	24000
D11B 11	2	35	25	20 x 50	2	24000
D11B 12	3	15	25	20 x 50	2	24000
D11B 13	4	40	25	20 x 50	2	24000
D11B 14	5	20	20	20 x 50	2	24000
D11B 15	1	50	25	25 x 50	2	24000
D11B 16	2	35	25	25 x 50	2	24000
D11B 17	3	15	25	25 x 50	2	24000
D11B 18	4	40	25	25 x 50	2	24000
D11B 19	5	20	20	25 x 50	2	24000

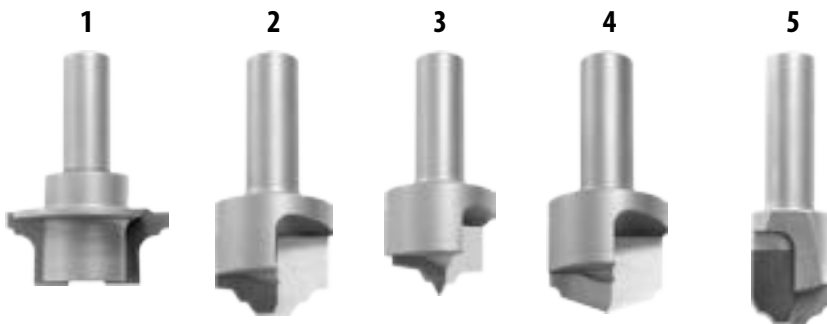

🇮🇹 Kit di utensili in diamante DP H4.5mm con corpo in acciaio speciale per lavorazioni di antine per cucine in MDF

🇬🇧 Kit comprising DP diamond tools, H4.5mm, with special steel body, for machining MDF kitchen cabinet doors

🇩🇪 Satz Diamantwerkzeuge PKD H 4,5 mm mit Körper aus Sonderstahl für Bearbeitungen von Küchenfronten aus MDF

🇪🇸 Juego de herramientas de diamante con plaquita en DP de H 4,5 mm y cuerpo de acero especial para mecanizar las puertas en MDF de los muebles de cocina

🇫🇷 Kit d'outils en diamant, DP H4,5 mm avec corps en acier spécial pour l'usinage de porte de cuisine en MDF.

🇷🇺 Комплект алмазного инструмента DP H4.5mm с корпусом из специальной стали для обработки кухонных створок из MDF

PRICE LIST

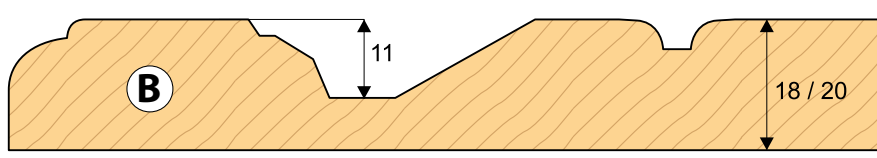

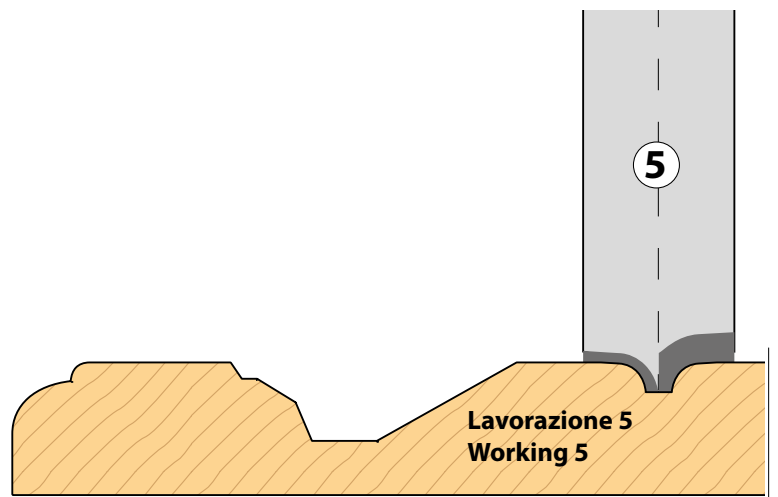
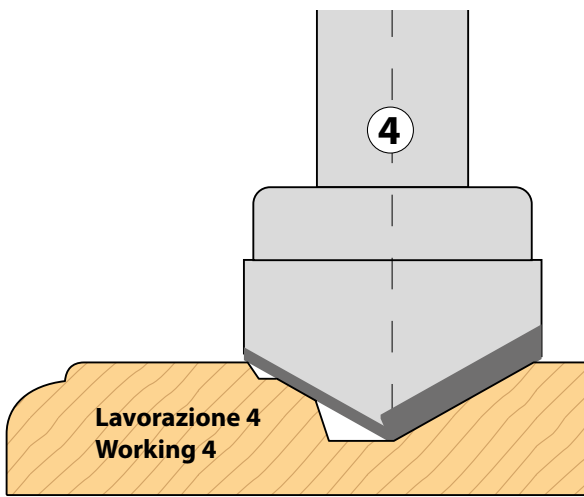
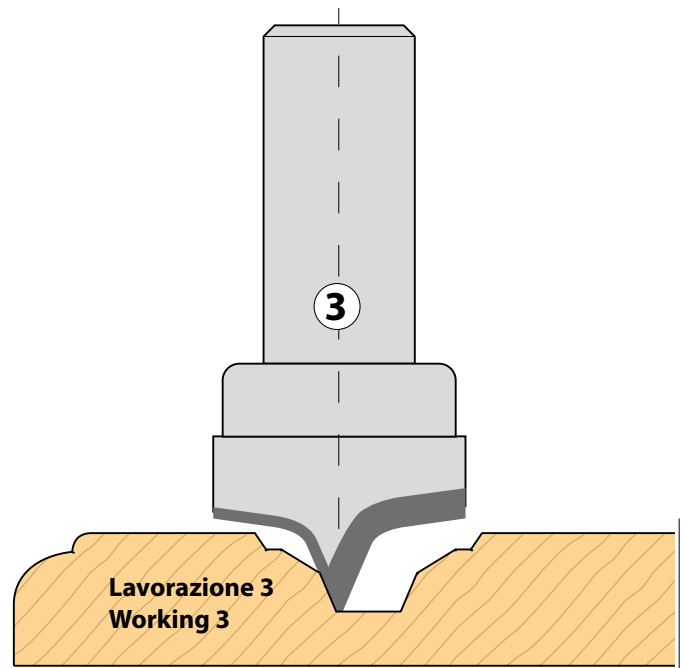
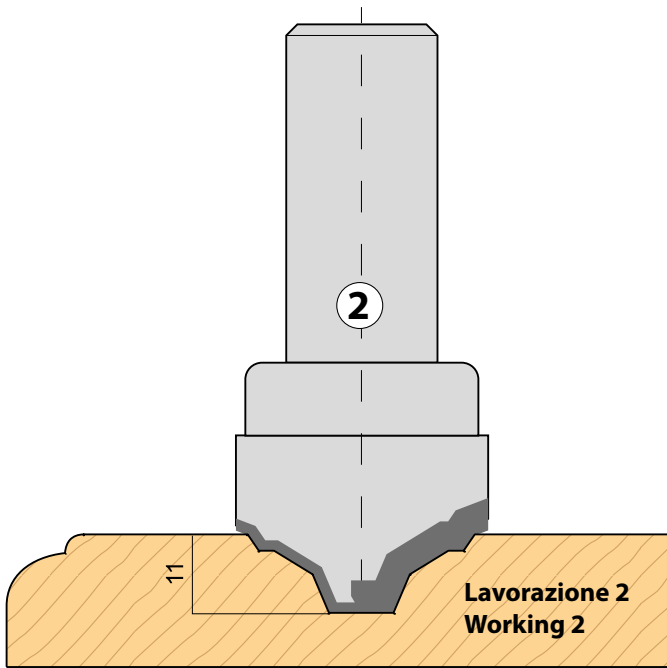
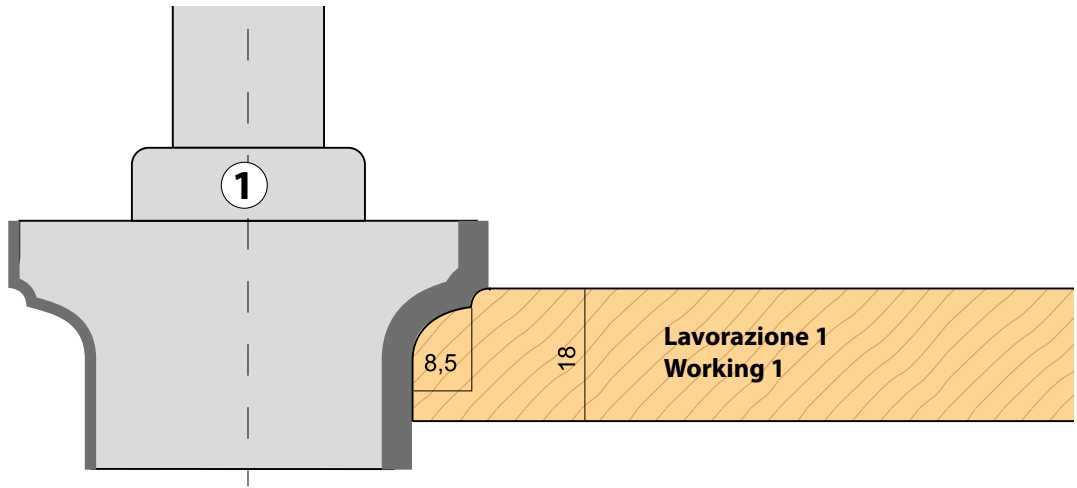

# Art. D11C

confezione di 5 punte in diamante Z2 con corpo in acciaio DP H 4,5 mm

Kit comprising DP diamond tools, H4.5mm

Satz Diamantwerkzeuge PKD H 4,5 mm

Juego de herramientas de diamante con plaquita en DP de H 4,5 mm

Kit d'outils en diamant, DP H4,5 mm

Комплект алмазного инструмента DP H4.5mm

Section INDEX

INDEX by article

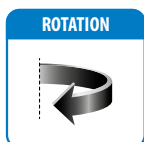
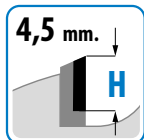

Cod.		∅ D mm	B mm	∅ d mm	Z	rpm max
D11C 10	1	50	25	20 x 50	2	24000
D11C 11	2	20	20	20 x 50	2	24000
D11C 12	3	25	25	20 x 50	2	24000
D11C 13	4	40	25	20 x 50	2	24000
D11C 14	5	40	25	20 x 50	2	24000
D11C 15	1	50	25	25 x 50	2	24000
D11C 16	2	20	20	25 x 50	2	24000
D11C 17	3	25	25	25 x 50	2	24000
D11C 18	4	40	25	25 x 50	2	24000
D11C 19	5	40	25	25 x 50	2	24000

🇮🇹 Kit di utensili in diamante DP H4.5mm con corpo in acciaio speciale per lavorazioni di antine per cucine in MDF

🇬🇧 Kit comprising DP diamond tools, H4.5mm, with special steel body, for machining MDF kitchen cabinet doors

🇩🇪 Satz Diamantwerkzeuge PKD H 4,5 mm mit Körper aus Sonderstahl für Bearbeitungen von Küchenfronten aus MDF

🇪🇸 Juego de herramientas de diamante con plaquita en DP de H 4,5 mm y cuerpo de acero especial para mecanizar las puertas en MDF de los muebles de cocina

🇫🇷 Kit d'outils en diamant, DP H4,5 mm avec corps en acier spécial pour l'usinage de porte de cuisine en MDF.

🇷🇺 Комплект алмазного инструмента DP H4.5mm с корпусом из специальной стали для обработки кухонных створок из MDF

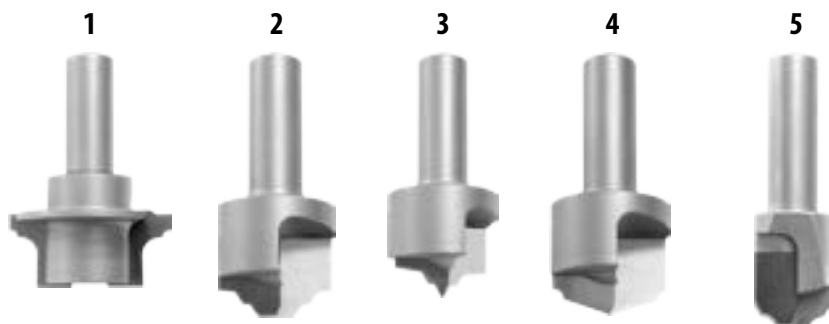

PRICE LIST

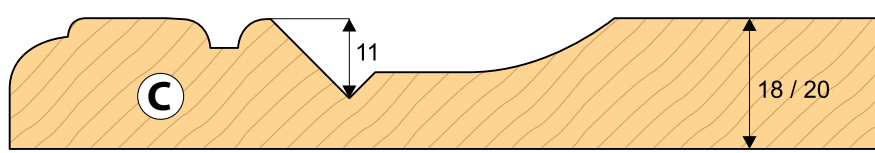
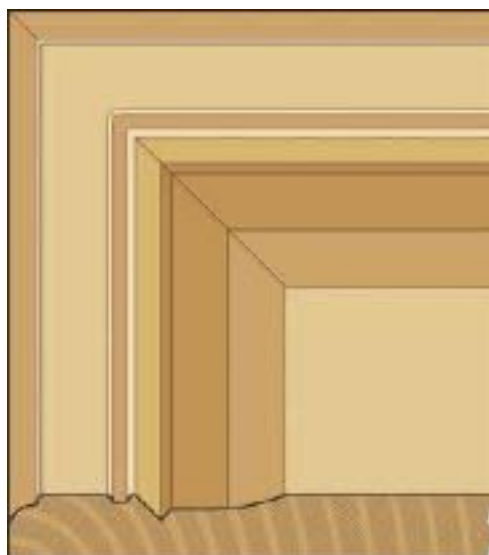



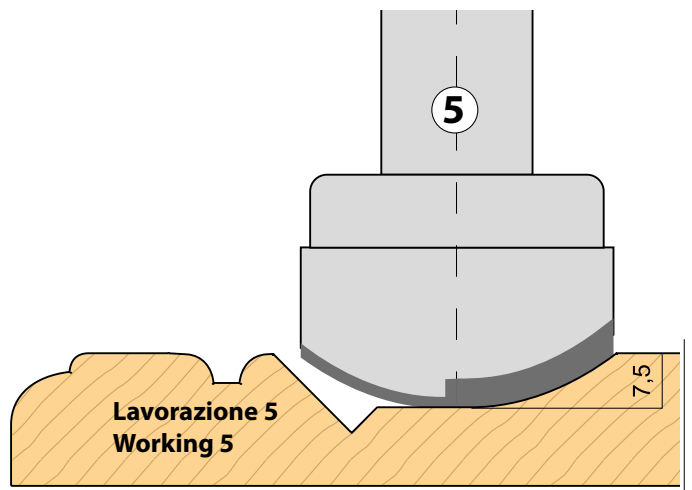
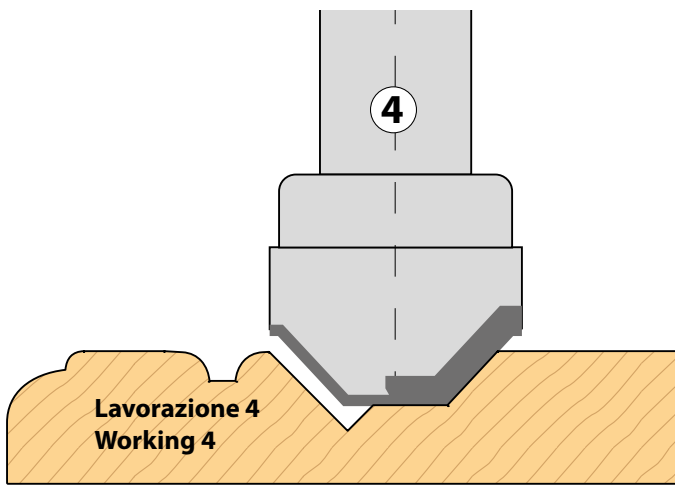
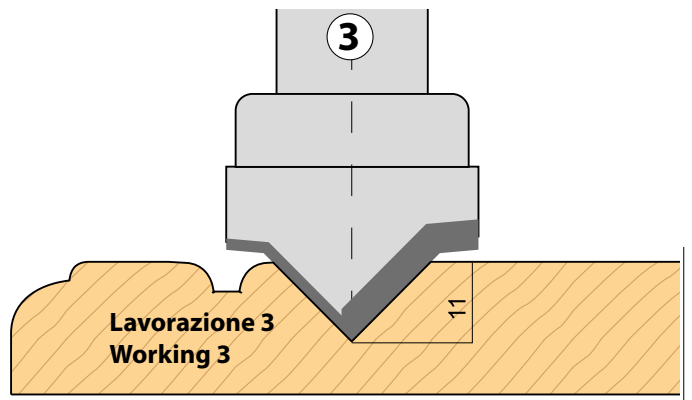
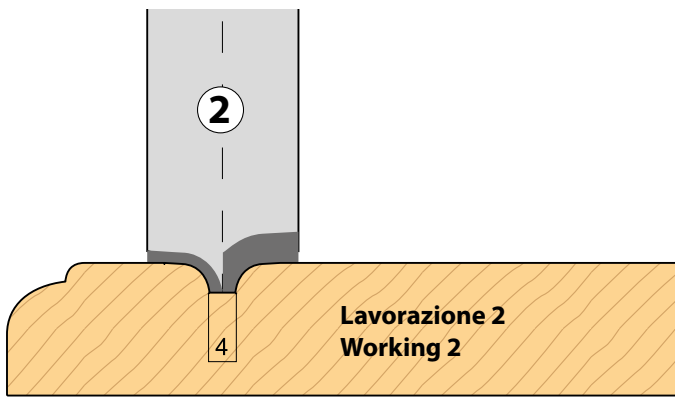
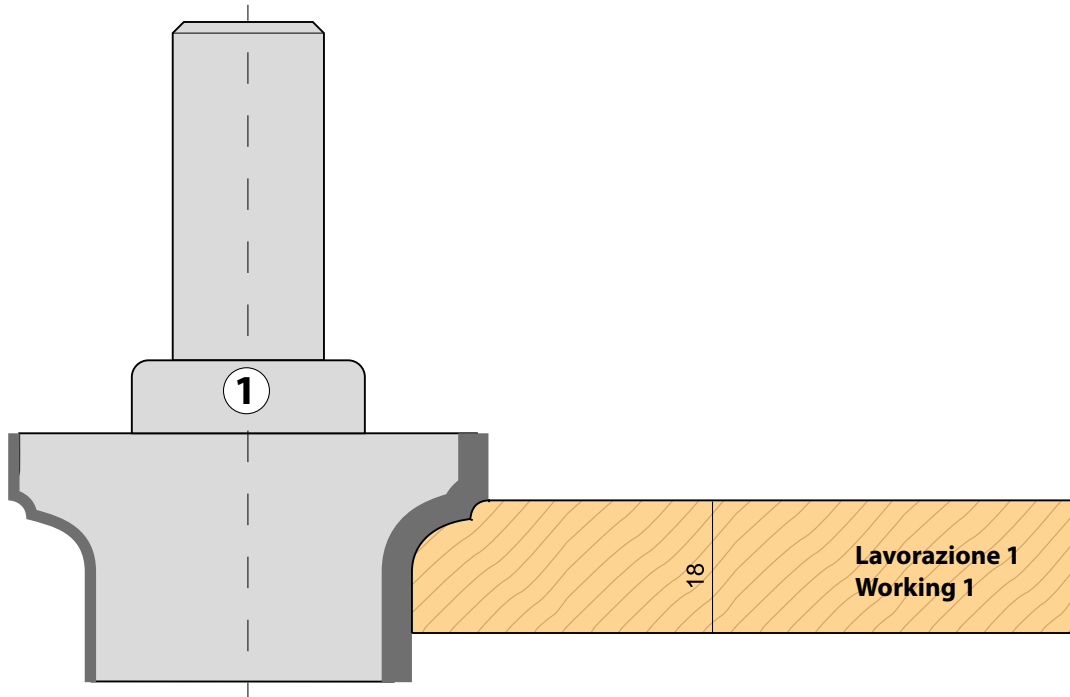

# Art. D11D

confezione di 4 punte in diamante Z2 con corpo in acciaio DP H 4,5 mm

Kit comprising DP diamond tools, H4.5mm

Satz Diamantwerkzeuge PKD H 4,5 mm

Juego de herramientas de diamante con plaquita en DP de H 4,5 mm

Kit d'outils en diamant, DP H4,5 mm

Комплект алмазного инструмента DP H4.5mm

Section INDEX

INDEX by article

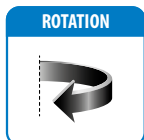
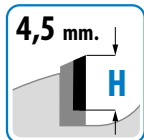

Cod.		ø D mm	B mm	ø d mm	Z	rpm max
D11D 10	1	50	25	20 x 50	2	24000
D11D 11	2	17	20	20 x 50	2	24000
D11D 12	3	40	20	20 x 50	2	24000
D11D 13	4	30	25	20 x 50	2	24000
D11D 14	1	50	25	25 x 50	2	24000
D11D 15	2	17	20	25 x 50	2	24000
D11D 16	3	40	20	25 x 50	2	24000
D11D 17	4	30	25	25 x 50	2	24000

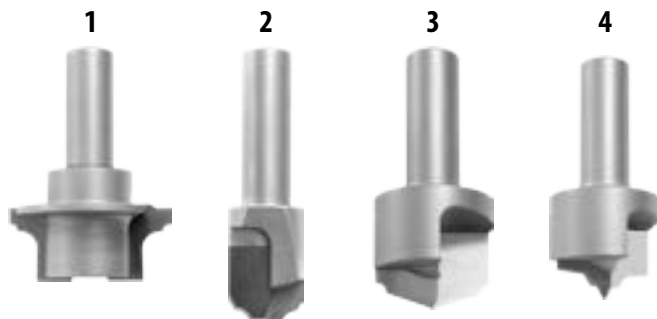

Kit di utensili in diamante DP H4.5mm con corpo in acciaio speciale per lavorazioni di antine per cucine in MDF

Kit comprising DP diamond tools, H4.5mm, with special steel body, for machining MDF kitchen cabinet doors

Satz Diamantwerkzeuge PKD H 4,5 mm mit Körper aus Sonderstahl für Bearbeitungen von Küchenfronten aus MDF

Juego de herramientas de diamante con plaquita en DP de H 4,5 mm y cuerpo de acero especial para mecanizar las puertas en MDF de los muebles de cocina

Kit d'outils en diamant, DP H4,5 mm avec corps en acier spécial pour l'usinage de porte de cuisine en MDF.

Комплект алмазного инструмента DP H4.5mm с корпусом из специальной стали для обработки кухонных створок из MDF

PRICE LIST

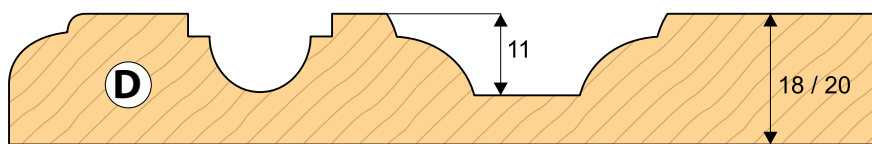

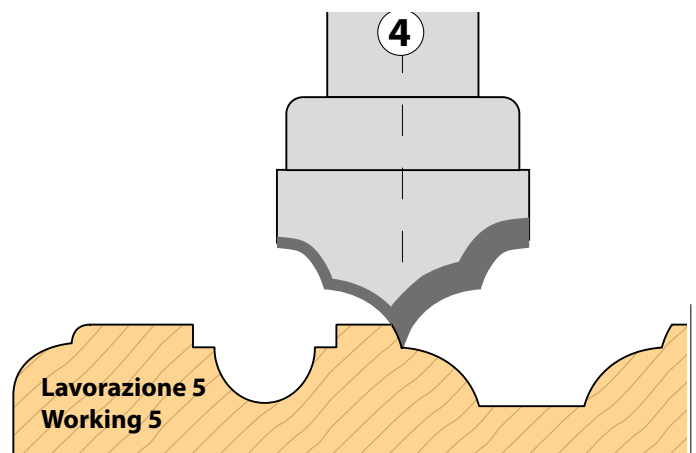
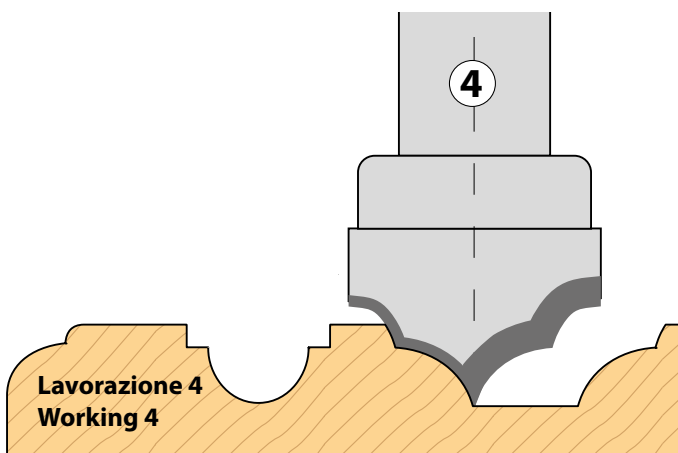
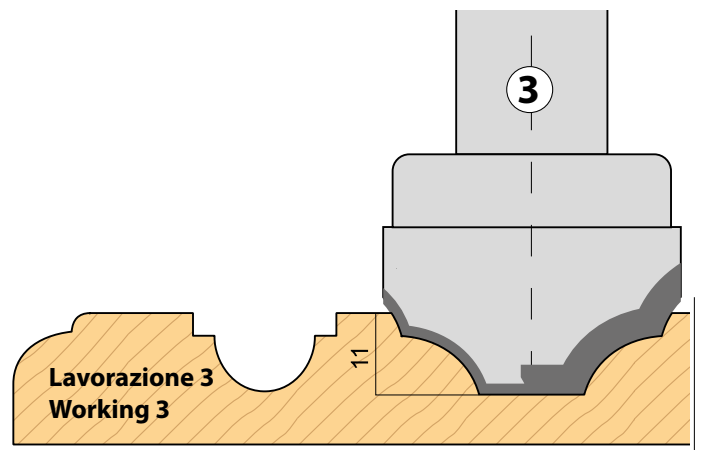
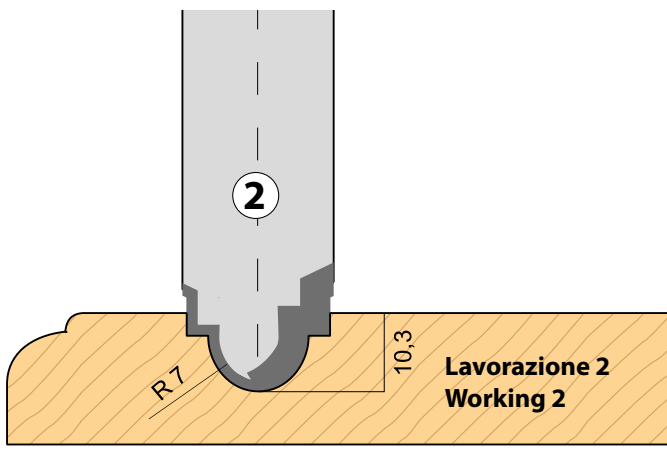
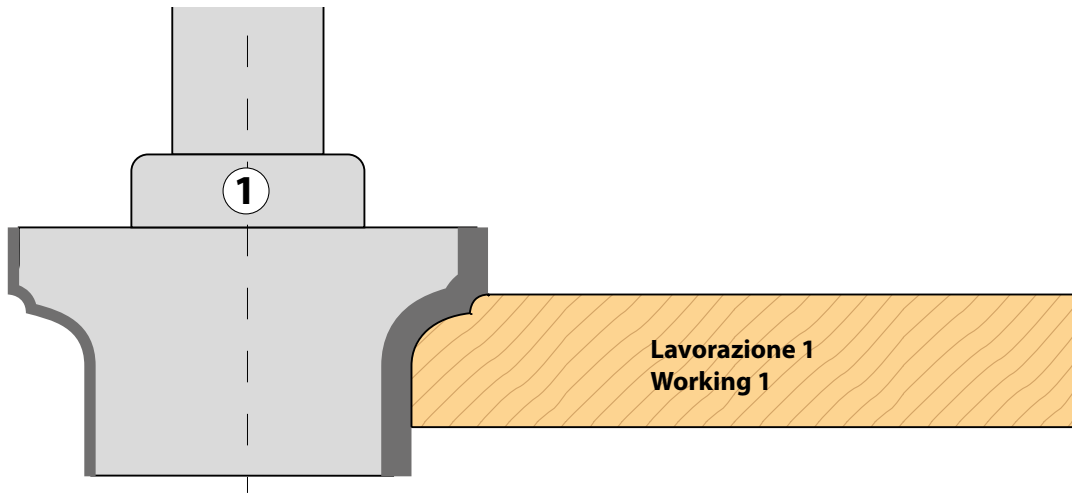



## **FRESE IN DIAMANTE ANTISCHEGGIA PER RETTIFICA**



**DIAMOND TOOLS ANTI-SPLIT FOR GRINDING**

**SPLITTERSCHUTZ DIAMANTFRÄSER ZUM SCHLEIFEN**

**FRESAS EN DIAMANTE INASTILLABLE DE AJUSTE**

**FRAISES EN DIAMANT ANTI ECHARDE POUR AJUSTEMENT**

**АЛМАЗНЫЕ ФРЕЗЫ АНТИ-СКОЛ ДЛЯ ШЛИФОВАНИЯ**



# frese in diamante antisceggia per rettifica

diamond tools anti-split  
for grinding

Spitterschutz Diamantfrä-  
ser zum Schleifen

Fresas en diamante inasti-  
llable de ajuste

fraises en diamant anti-  
echarde pour ajustement

алмазные фрезы ан-  
ти-скол для шлифования

Section  
INDEX

INDEX  
by article

**Art. D250**

pag.  
87

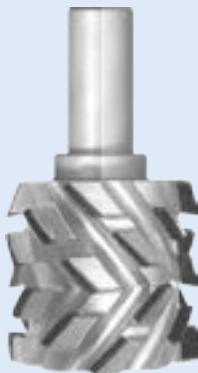

**Art. D310**

pag.  
91



**Art. D260**

pag.  
88

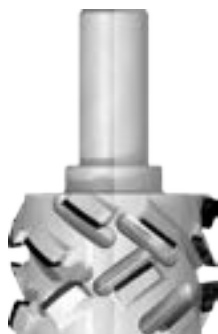

**Art. D255**

pag.  
92



**Art. D251**

pag.  
89



**Art. D265**

pag.  
93



**Art. D253**

pag.  
90



Section  
INDEX

DP diamond helical router bit Z4+4 for finishing, steel body H 4.5 mm

Diamant-Spiralfräser Z4+4 zum Schleifen, Körper aus Stahl, PKD H 4,5 mm

fresa de diamante helicoidal Z4+4 para rectificar con cuerpo en acero y plaquita en DP de H 4,5 mm

Fraise diamant hélicoïdale de rectification Z4+4 avec corps en acier DP H 4,5 mm

Алмазная спиральная фреза для коррекции Z4+4 корпус из стали DP H 4,5 mm

INDEX  
by article

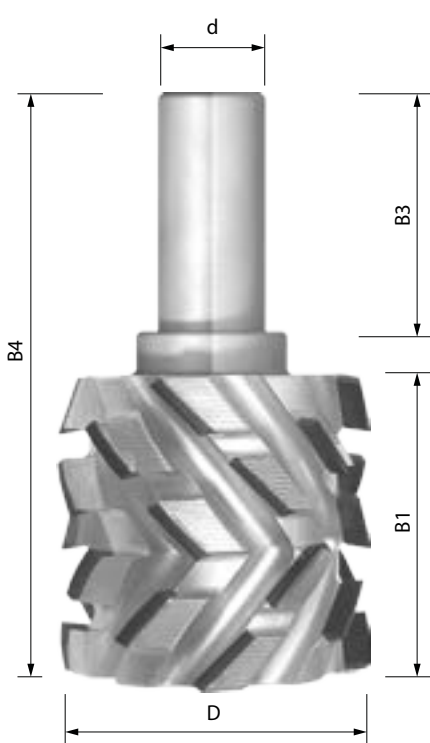

ANGOLO ASSIALE  
AXIAL ANGLE  
**40°**

SYMMETRIC

4,5 mm.  
H

Cod.	D mm	B1 mm	B3 mm	B4 mm	d mm	Z tot	rpm max
D250 10	50	25	50	85	20	4+4	18000
D250 11	50	35	60	105	20	4+4	18000
D250 12	50	45	50	105	20	4+4	18000
D250 13	50	55	60	125	20	4+4	18000
D250 14	60	25	50	85	20	4+4	18000
D250 15	60	35	60	105	20	4+4	18000
D250 16	60	45	50	105	20	4+4	18000
D250 17	60	55	60	125	20	4+4	18000
D250 18	80	25	50	85	20	4+4	18000
D250 19	80	35	60	105	20	4+4	18000
D250 20	80	45	50	105	20	4+4	18000
D250 21	80	55	60	125	20	4+4	18000
D250 22	80	80	60	150	25	4+4	18000

PRICE  
LIST

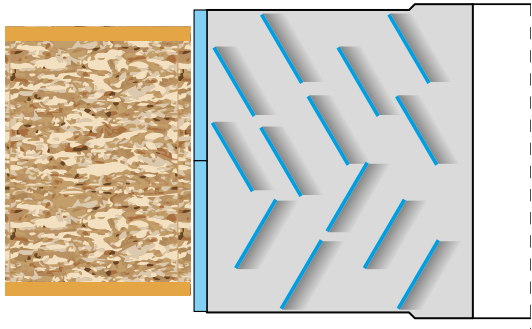

DISPOSIZIONE SIMMETRICA  
SYMMETRIC TIP ARRANGEMENT

Fresa in diamante Z4+4, con placchetta riaffilabile H4,5 mm (max 8 riaffilature), 8 divisioni in elica, assialità confluyente al centro, angolo assiale da 40° per ottenere ottime finiture sul pannello. Ideale per lavorazione di bordatura di pannelli in truciolare rivestito, MDF rivestito e multistrato rivestito.

Fresa de diamante Z4+4 con plaquita de 4,5 mm de altura (reafilable 8 veces, como máximo), ocho secciones en cada hélice, axialidad confluyente en el centro y ángulo axial de 40° para obtener excelentes acabados en el panel. Es ideal para contornear paneles de aglomerado revestido, MDF revestido y contrachapado revestido.

DP rectifying shank cutter Z4+4 with DP tips H4,5 mm resharpened up to 8 times, eight helicoidal wing, cutting angle 40°. Suitable for working on laminated chipboard panels, laminated MDF and laminated plywood.

Fraise en diamant Z4+4, avec plaquette réaffûtable H 4,5 mm (max 8 réaffûtages), 8 divisions en hélice, axialité confluyente au centre, angle axial de 40° pour obtenir des finitions optimales sur panneaux. Idéale pour l'usinage de chant de panneaux agglomérés revêtus, MDF revêtu, multicouches revêtues.

Diamantfräser Z4+4, mit Schneide H 4,5 mm (max. 8 Mal nachschleifbar), 8 Schneidreihen, mittig ausgerichtet, Achswinkel 40° für eine hervorragende Oberflächengüte der Platte. Ideal zum Besäumen von beschichteten Spanplatten, beschichtetem MDF und Mehrschichtplatten.

Алмазная фреза Z4+4 с заточиваемыми ножами H4,5 мм (макс. 8 раз заточка), 8 делений спирали, осевое слияние в центре, осевой угол 40°, что позволяет получить отличную отделку панели. Отлично подходит для обработки кромки панелей ДСП с покрытием, МДФ панелей с покрытием и многослойных панелей с покрытием.



DP diamond radius router bit Z3+3 for nesting, steel body H 4.5 mm

Diamant-Spiralfräser Z3+3 zum Schleifen, Körper aus Stahl, DP H 4,5 mm

fresa de diamante helicoidal Z3+3 para rectificar con cuerpo en acero y plaquita en DP de H 4,5 mm

Fraise en diamant hélicoïdale pour rectifier Z3+3 avec corps en acier DP H 4,5 mm

Алмазная спиральная фреза для коррекции Z3+3 корпус из стали DP H 4,5 mm

Section INDEX

INDEX by article

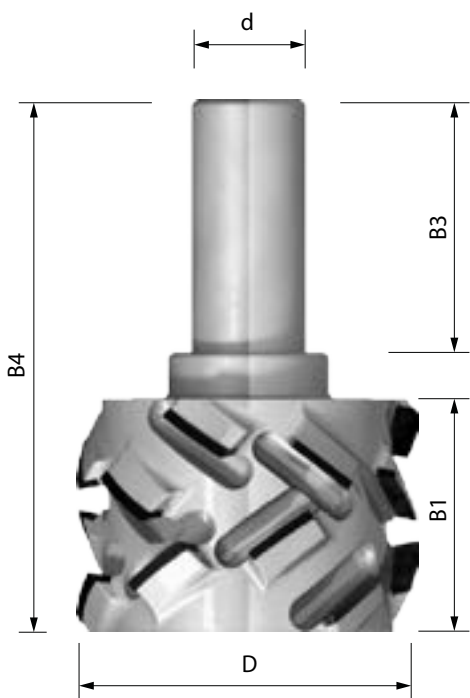

ANGOLO ASSIALE  
AXIAL ANGLE  
**54,9°**

SYMMETRIC

4,5 mm.  
H

PRICE LIST

Cod.	D mm	B1 mm	B3 mm	B4 mm	d mm	Z tot	rpm max
D260 10	50	25	50	85	20	3+3	18000
D260 11	50	35	60	105	20	3+3	18000
D260 12	50	45	50	105	20	3+3	18000
D260 13	50	55	60	125	20	3+3	18000
D260 14	60	25	50	85	20	3+3	18000
D260 15	60	35	60	105	20	3+3	18000
D260 16	60	45	50	105	20	3+3	18000
D260 17	60	55	60	125	20	3+3	18000
D260 18	80	25	50	85	20	3+3	18000
D260 19	80	35	60	105	20	3+3	18000
D260 20	80	45	50	105	20	3+3	18000
D260 21	80	55	60	125	20	3+3	18000
D260 22	80	80	60	150	25	3+3	18000

Fresa in diamante Z3+3, con placchetta riaffilabile H4,5 mm (max 8 riaffilature), 6 divisioni in elica, assialità confluyente al centro, angolo assiale da 54,9° per ottenere ottime finiture sul pannello. Ideale per lavorazione di bordatura di pannelli in truciolare rivestito, MDF rivestito e multistrato rivestito.

Fresa de diamante Z3+3 con plaquita de 4,5 mm de altura (reafilable 8 veces, como máximo), seis secciones en cada hélice, axialidad confluyente en el centro y ángulo axial de 54,9° para obtener excelentes acabados en el panel. Es ideal para contornear paneles de aglomerado revestido, MDF revestido y contrachapado revestido.

DP rectifying shank cutter Z3+3 with DP tips H4,5 mm resharpened up to 8 times, six helicoidal wing, cutting angle 54,9°. Suitable for working on laminated chipboard panels, laminated MDF and laminated plywood.

Fraise en diamant Z3+3 avec plaquettes réaffûtées H 4,5 mm (max 8 réaffutages), 6 divisions en hélice, axialité confluyente au centre, angle axial de 54,9° pour obtenir une finition optimale sur le panneau, idéale pour l'usinage de chant de panneaux en aggloméré revêtus, MDF revêtu et multicouche revêtu.

Diamantfräser Z3+3, mit Schneide H 4,5 mm (max. 8 Mal nachschleifbar), 6 Schneidreihen, mittig ausgerichtete Schneiden, Achswinkel 54,9° für eine hervorragende Oberflächengüte der Platte. Ideal zum Besäumen von beschichteten Spanplatten, beschichtetem MDF und Mehrschichtplatten.

Алмазная фреза Z3+3 с заточиваемыми ножами H4,5 mm (макс. 8 раз заточка), 6 делений спирали, осевое слияние в центре, осевой угол 54,9°, что позволяет получить отличную отделку панели. Отлично подходит для обработки кромки панелей ДСП с покрытием, MDF панелей с покрытием и мультислойных панелей с покрытием.

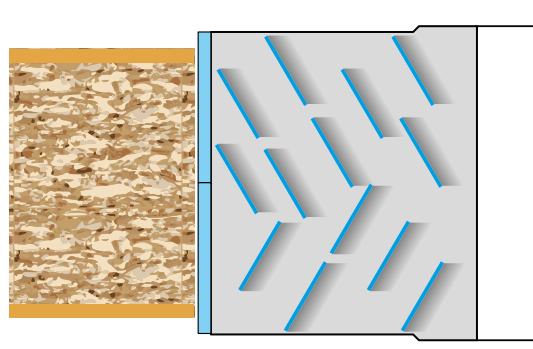

DISPOSIZIONE SIMMETRICA  
SYMMETRIC TIP ARRANGEMENT





# Art. D251

## fresa in diamante da rettifica su HSK63F Z4+4 DP H 4,5 mm

Section  
INDEX

DP diamond router bit Z4+4 for finishing, HSK63F shank, H 4.5 mm

Diamantfräser zum Schleifen auf HSK63F Z4+4 PKD H 4,5 mm

fresa de diamante para retificar Z4+4 con portacabezal en HSK63F y plaquita en DP de H 4,5 mm

Fraise en diamant pour retifier sur HSK63F Z4+4 DP H 4,5 mm

спиральная фреза для коррекции на HSK63F Z4+4 DP H 4,5 mm

INDEX  
by article

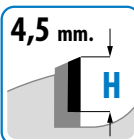
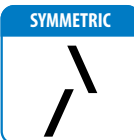

PRICE  
LIST

Cod.	D mm	B mm	d mm	Z tot	rpm max
D251 10	70	55	30	4+4	18000
D251 11	70	75	30	4+4	18000

Fresa in diamante Z4+4, con placchetta riaffilabile H4,5 mm (max 8 riaffilature), 8 divisioni in elica, assialità confluyente al centro, angolo assiale da 40° per ottenere ottime finiture sul pannello. Ideale per lavorazione di bordatura di pannelli in truciolare rivestito, MDF rivestito e multistrato rivestito.

DP rectifying shank cutter Z4+4 with DP tips H4,5 mm resharpened up to 8 times, eight helicoidal wing, cutting angle 40°. Suitable for working on laminated chipboard panels, laminated MDF and laminated plywood.

Diamantfräser Z4+4, mit Schneide H 4,5 mm (max. 8 Mal nachschleifbar), 8 Schneidereien, mittig ausgerichtet, Achswinkel 40° für eine hervorragende Oberflächengüte der Platte. Ideal zum Besäumen von beschichteten Spanplatten, beschichtetem MDF und Mehrschichtplatten.

Fresa de diamante Z4+4 con plaquita de 4,5 mm de altura (reafilable 8 veces, como máximo), ocho secciones en cada hélice, axialidad confluyente en el centro y ángulo axial de 40° para obtener excelentes acabados en el panel. Es ideal para contornear paneles de aglomerado revestido, MDF revestido y contrachapado revestido.

Fraise en diamant Z4+4 avec plaquettes réaffûtées H 4,5 mm (max 8 réaffûtages), 8 divisions en hélice, axialité confluyente au centre, angle axial de 40° pour obtenir une finition optimale sur le panneau, idéale pour l'usinage de chant de panneaux en aggloméré revêtus, MDF revêtu et multicouche revêtue

Алмазная фреза Z4+4 с заточиваемой пластиной H4,5 mm (макс. 8 заточек), 8 делений на спирали, ось по центру, осевой угол 40° что позволяет получить отличную обработку панели. Идеально подходит для обработки кромки шпонированных ДСП, МФ и мультислойных панелей.

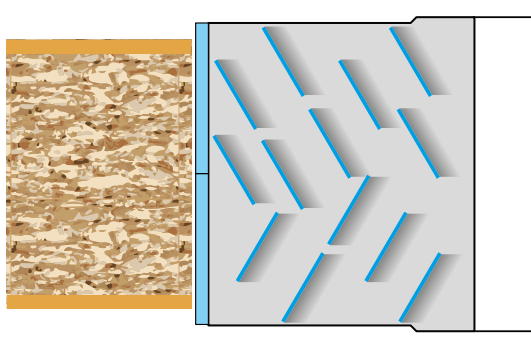

DISPOSIZIONE SIMMETRICA  
SYMMETRIC TIP ARRANGEMENT



DP diamond router bit Z3+3 for finishing, HSK63F shank, H 4.5 mm

Diamantfräser zum Schleifen auf HSK63F Z3+3 PKD H 4,5 mm

fresa de diamante para retificar Z3+3 con portacabezal en HSK63F y plaquita en DP de H 4,5 mm

Fraise en diamant pour retifier sur HSK63F Z3+3 DP H 4,5 mm

Алмазная спиральная фреза для коррекции на HSK63F Z3+3 DP H 4,5 mm

Section INDEX

INDEX by article



ANGOLO ASSIALE AXIAL ANGLE

54,9°

SYMMETRIC



4,5 mm.



PRICE LIST

Cod.	D mm	B mm	d mm	Z tot	rpm max
D253 10	70	50	30	3+3	18000
D253 11	70	75	30	3+3	18000

Fresa in diamante Z3+3, con placchetta riaffilabile H4,5 mm (max 8 riaffilature), 6 divisioni in elica, assialità confluyente al centro, angolo assiale da 54,9° per ottenere ottime finiture sul pannello. Ideale per lavorazione di bordatura di pannelli in truciolare rivestito, MDF rivestito e multistrato rivestito.

DP rectifying shank cutter Z3+3 with DP tips H4,5 mm resharpened up to 6 times, six helicoidal wing, cutting angle 54,9°. Suitable for working on laminated chipboard panels, laminated MDF and laminated plywood.

Diamantfräser Z3+3, mit Schneide H 4,5 mm (max. 8 Mal nachschleifbar), 6 Schneidereien, mittig ausgerichtete Schneiden, Achswinkel 54,9° für eine hervorragende Oberflächengüte der Platte. Ideal zum Besäumen von beschichteten Spanplatten, beschichtetem MDF und Mehrschichtplatten.

Fresa de diamante Z3+3 con plaquita de 4,5 mm de altura (reafilable 8 veces, como máximo), seis secciones en cada hélice, axialidad confluyente en el centro y ángulo axial de 54,9° para obtener excelentes acabados en el panel. Es ideal para contornear paneles de aglomerado revestido, MDF revestido y contrachapado revestido.

Fraise en diamant Z3+3 avec plaquettes réaffûtées H 4,5 mm (max 8 réaffutages), 6 divisions en hélice, axialité confluyente au centre, angle axial de 54,9° pour obtenir une finition optimale sur le panneau, idéale pour l'usinage de chant de panneaux en aggloméré revêtus, MDF revêtu et multicouche revêtue

Алмазная фреза Z3+3 с заточиваемой пластиной H4,5 mm (макс. 8 заточек), 6 делений на спирали, ось по центру, осевой угол от 54,9° что позволяет получить отличную обработку панели. Идеально подходит для обработки кромки шпонированных ДСП, MDF и мультислойных панелей.

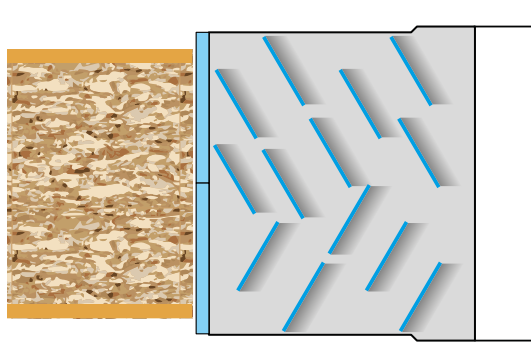

DISPOSIZIONE SIMMETRICA  
SYMMETRIC TIP ARRANGEMENT



Section  
INDEX

DP diamond anti-splinter head with reversible knives, H3mm, on HSK63F, 45° axial angle

Diamant-Fügefräser mit Wendeplatten PKD H 3 mm, auf HSK63F, Achswinkel 45°

Cabezal antiastillante de diamante con cuchillas desechables, plaquita en DP de H 3 mm, ángulos axiales de 45° y portacabezal en HSK63F

P.O. anti éclat en diamant avec plaquettes à jeter, DP H3 mm, sur HSK63F, axialité 45°

Фреза алмазная (анти-сколов) со сменными ножами DP H3mm, для HSK63F, угол 45°

INDEX  
by article

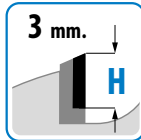
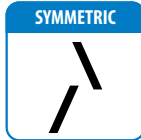

PRICE  
LIST

Cod.	D mm	B mm	d mm	Z tot	rpm max
D310 10	70	47	30	2x5 (10)	18000
D310 11	70	65	30	3x7 (21)	18000

Cod.		Parti di ricambio Spare Parts	Dimensions mm
D310 20		Coltello / Knife	16 x 15 x 5
VT 5 x 7 torx		Vite / Screw	VT 5 x 7 torx
CH T20 torx		Chiave / Allen key	T20 torx

Testa antischeggia in diamante con coltelli a gettare ri-affilabili DP H3mm, costruite con corpo in lega speciale Ergal, Z=2/3, assialità 45°, simmetriche ed asimmetriche, per lavorazioni di pannelli truciolare e nobilitati.

DP diamond anti-splinter head with sharpenable reversible knives, H3mm, manufactured with special Ergal, Z=2/3, 45° axial angle, symmetrical and asymmetrical, for machining particleboard and laminated panels.

Diamant-Fügefräser mit Wendschneidplatten, nachschleifbar, PKD H 3 mm, hergestellt mit Körper aus Speziallegierung Ergal, Z=2/3, Achswinkel 45°, symmetrisch und asymmetrisch, für Bearbeitungen von Spanplatten und beschichteten Platten.

Cabezal antiastillante de diamante con cuchillas desechables o reafilables y plaquita en DP de H 3 mm. Cuenta con cuerpo de aleación especial Ergal, Z=2/3, ángulos axiales de 45°, diseño simétrico y asimétrico, para mecanizar paneles de aglomerado y melamina.

P.O. anti éclat en diamant avec plaquettes à jeter réaffûttables, DP H3 mm, construite avec corps en alliage spécial Ergal, Z/3, axialité 45°, symétriques et asymétriques, pour l'usinage de panneaux agglomérés et anoblis.

Фреза алмазная (анти-сколов) со сменными, затачиваемыми ножами DP H3mm, Корпус сделан из специального сплава Ergal, Z=2/3, угол 45°, асимметричные и симметричные, для обработки ДСП и панелей с покрытием.

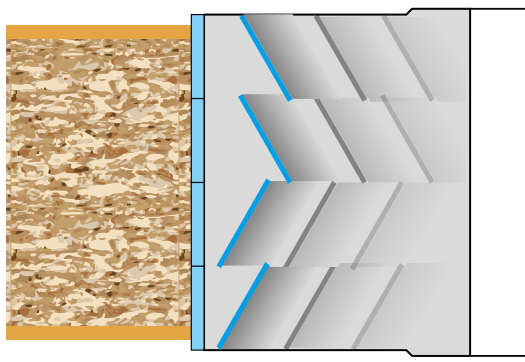

DISPOSIZIONE SIMMETRICA  
SYMMETRIC TIP ARRANGEMENT



DP diamond helical router bit Z3+3 for finishing, steel body, H 4.5 mm

Diamant-Spiralfräser Z3+3 zum Schleifen mit Körper aus Stahl, PKD H 4,5 mm

fresa de diamante helicoidal Z3+3 para rectificar con cuerpo en acero y plaquita en DP de H 4,5 mm

Fraise en diamant hélicoïdale de rectification Z3+3 avec corps en acier DP H 4,5 mm

Алмазная спиральная фреза для коррекции Z3+3 корпус из стали DP H 4,5 mm

Section INDEX

INDEX by article

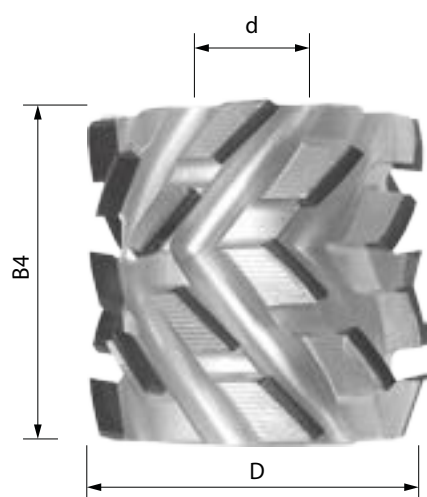

ANGOLO ASSIALE AXIAL ANGLE

45°

SYMMETRIC



4,5 mm.

H

PRICE LIST

Cod.	D mm	B4 mm	d mm	Z tot	rpm max
D255 10	100	40	35	3+3	18000
D255 11	100	40	40	3+3	18000
D255 12	100	40	50	3+3	18000
D255 13	100	48	35	3+3	18000
D255 14	100	48	40	3+3	18000
D255 15	100	48	50	3+3	18000
D255 16	100	65	35	3+3	18000
D255 17	100	65	40	3+3	18000
D255 18	100	65	50	3+3	18000
D255 19	125	40	35	3+3	18000
D255 20	125	40	40	3+3	18000
D255 21	125	40	50	3+3	18000
D255 22	125	48	35	3+3	18000
D255 23	125	48	40	3+3	18000
D255 24	125	48	50	3+3	18000
D255 25	125	65	35	3+3	18000
D255 26	125	65	40	3+3	18000
D255 27	125	65	50	3+3	18000

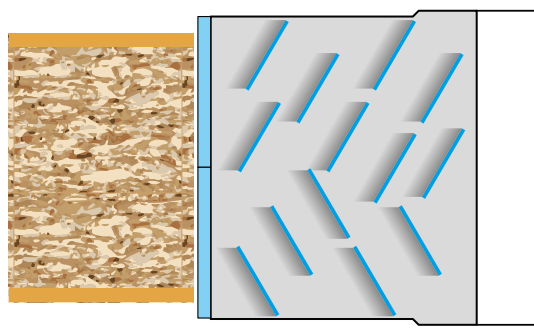

DISPOSIZIONE SIMMETRICA SYMMETRIC TIP ARRANGEMENT

Fresa in diamante Z3+3, con placchetta riaffilabile H4,5 mm (max 8 riaffilature), 8 divisioni in elica, assialità confluyente al centro, angolo assiale da 45° per ottenere ottime finiture sul pannello. Ideale per lavorazione di bordatura di pannelli in truciolare rivestito, MDF rivestito e multistrato rivestito.

Fresa de diamante Z3+3 con plaquita de 4,5 mm de altura (reafilable 8 veces, como máximo), ocho secciones en cada hélice, axialidad confluyente en el centro y ángulo axial de 45° para obtener excelentes acabados en el panel. Es ideal para contornear paneles de aglomerado revestido, MDF revestido y contrachapado revestido.

DP rectifying shank cutter Z3+3 with DP tips H4,5 mm resharpened up to 8 times, eight helical wing, cutting angle 45°. Suitable for working on laminated chipboard panels, laminated MDF and laminated plywood.

Fraise en diamant Z3+3, avec plaquette réaffûtable H 4,5 mm (max 8 réaffutages), 8 divisions en hélice, axialité confluyente au centre, angle axial de 40° pour obtenir des finitions optimales sur panneaux. Idéale pour l'usinage de chant de panneaux agglomérés revêtus, MDF revêtu, multicouches revêtues.

Diamantfräser Z3+3, mit Schneide H 4,5 mm (max. 8 Mal nachschleifbar), 8 Schneidereien, mittig ausgerichtet, Achswinkel 45° für eine hervorragende Oberflächengüte der Platte. Ideal zum Besäumen von beschichteten Spanplatten, beschichtetem MDF und Mehrschichtplatten.

Алмазная фреза Z3+3 с затачиваемыми ножами H4,5 mm (макс. 8 раз заточка), 8 делений спирали, осевое слияние в центре, осевой угол 45°, что позволяет получить отличную отделку панели. Отлично подходит для обработки кромки панелей ДСП с покрытием, МДФ панелей с покрытием и мультислойных панелей с покрытием.

Section  
INDEX

DP diamond helical router bit Z3+3 for contouring, steel body, H 4.5 mm

Diamant-Spiralfräser Z3+3 zum Schleifen mit Körper aus Stahl, PKD H 4,5 mm

fresa de diamante helicoidal Z3+3 para rectificar con cuerpo en acero y plaquita en DP de H 4,5 mm

Fraise en diamant hélicoïdale de rectification Z3+3 avec corps en acier DP H 4,5 mm

Алмазная спиральная фреза для коррекции Z3+3 корпус из стали DP H 4,5 mm

INDEX  
by article

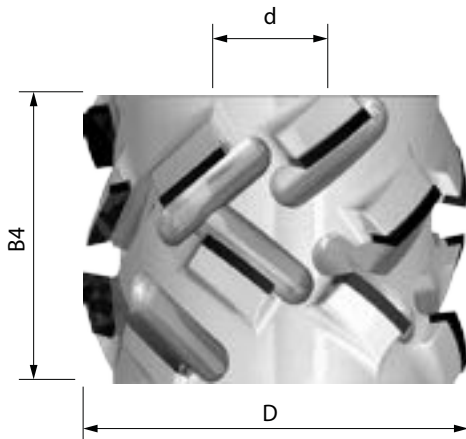

ANGOLO ASSIALE  
AXIAL ANGLE

54,9°

SYMMETRIC



4,5 mm.



PRICE  
LIST

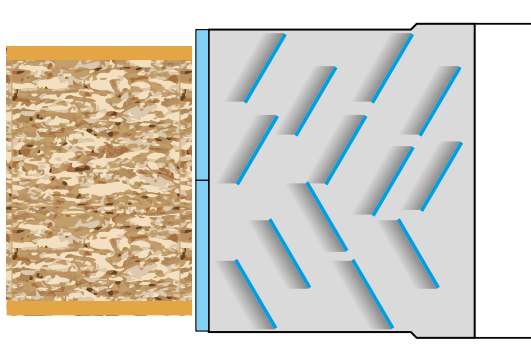

DISPOSIZIONE SIMMETRICA  
SYMMETRIC TIP ARRANGEMENT

Cod.	D mm	B4 mm	d mm	Z tot	rpm max
D265 10	100	40	35	3+3	18000
D265 11	100	40	40	3+3	18000
D265 12	100	40	50	3+3	18000
D265 13	100	50	35	3+3	18000
D265 14	100	50	40	3+3	18000
D265 15	100	50	50	3+3	18000
D265 16	100	60	35	3+3	18000
D265 17	100	60	40	3+3	18000
D265 18	100	60	50	3+3	18000
D265 19	125	40	35	3+3	18000
D265 20	125	40	40	3+3	18000
D265 21	125	40	50	3+3	18000
D265 22	125	50	35	3+3	18000
D265 23	125	50	40	3+3	18000
D265 24	125	50	50	3+3	18000
D265 25	125	60	35	3+3	18000
D265 26	125	60	40	3+3	18000
D265 27	125	60	50	3+3	18000

Fresa in diamante Z3+3, con placchetta riaffilabile H4,5 mm (max 8 riaffilature), 6 divisioni in elica, assialità confluyente al centro, angolo assiale da 54,9° per ottenere ottime finiture sul pannello. Ideale per lavorazione di bordatura di pannelli in truciolare rivestito, MDF rivestito e multistrato rivestito.

DP rectifying shank cutter Z3+3 with DP tips H4,5 mm resharp-ened up to 8 times, six helicoidal wing, cutting angle 54,9°. Suitable for working on laminated chipboard panels, laminated MDF and laminated plywood.

Diamantfräser Z3+3, mit Schneide H 4,5 mm (max. 8 Mal nachschleifbar), 6 Schneidereien, mittig ausgerichtete Schneiden, Achswinkel 54,9° für eine hervorragende Oberflächengüte der Platte. Ideal zum Besäumen von beschichteten Spanplatten, beschichtetem MDF und Mehrschichtplatten.

Fresa de diamante Z3+3 con plaquita de 4,5 mm de altura (reaffilable 8 veces, como máximo), seis secciones en cada hélice, axialidad confluyente en el centro y ángulo axial de 54,9° para obtener excelentes acabados en el panel. Es ideal para contornear paneles de aglomerado revestido, MDF revestido y contrachapado revestido.

Fraise en diamant Z3+3, avec plaquette réaffûtable H 4,5 mm (max 8 réaffûtages), 6 divisions en hélice, axialité confluyente au centre, angle axial de 54,9° pour obtenir des finitions optimales sur panneaux. Idéale pour l'usinage de chant de panneaux agglomérés revêtus, MDF revêtu, multicouches revêtues.

Алмазная фреза Z3+3 с заточиваемыми ножами H4,5 mm (макс. 8 раз заточка), 6 делений спирали, осевое слияние в центре, осевой угол 54,9°, что позволяет получить отличную отделку панели. Идеально для обработки кромки панелей ДСП с покрытием, MDF панелей с покрытием и многослойных панелей с покрытием.





## **FRESE IN DIAMANTE PER BORDATRICE**



**EDGEBANDING DIAMOND TOOLS**

**DIAMANTFRÄSER FÜR KANTENBANDER MASCHINE**

**FRESAS EN DIAMANTE PARA BANDA DE BORDE**

**FRAISES EN DIAMANT POUR PLAQUEUSE**

**АЛМАЗНЫЕ ФРЕЗЫ ДЛЯ КРОМКООБЛИЦОВОЧНОГО СТАНКА**



# frese in diamante per bordatrice

edgebanding diamond tools

diamantfräser für kantenbandermaschine

fresas en diamante para banda de borde

fraises en diamant pour plaqueuse

алмазные фрезы для кромкооблицовочного станка

Section  
INDEX

INDEX  
by article

**Art. D429**

pag.  
97



**Art. D504**

pag.  
99



**Art. D401**

pag.  
103



**Art. D413**

pag.  
119



**Art. D437**

pag.  
97



**Art. D503**

pag.  
100



**Art. D403**

pag.  
107



**Art. D419**

pag.  
122



**Art. D501**

pag.  
98



**Art. D505**

pag.  
100



**Art. D402**

pag.  
111



**Art. D502**

pag.  
98



**Art. D307**

pag.  
101



**Art. D404**

pag.  
115





# Art. D429

## Frese in diamante per bordatrice DP H2.5mm / 4.5mm

Section INDEX

DP diamond cutters for edgebander, H2.5mm/4.5mm

Diamantfräser für Kantenanleimmaschine PKD H 2,5 mm / 4,5 mm

Fresas de diamante con placa en DP de H 2,5 mm / 4,5 mm para canteadora

Fraises en diamant pour plaqueuse de chant, DP H 2,5 mm / 4,5 mm

Фреза алмазная для кромкооблицовочного станка DP H2.5mm/4.5mm

INDEX by article



ANGOLO ASSIALE AXIAL ANGLE

0°

2,5 mm.

4,5 mm.

PRICE LIST

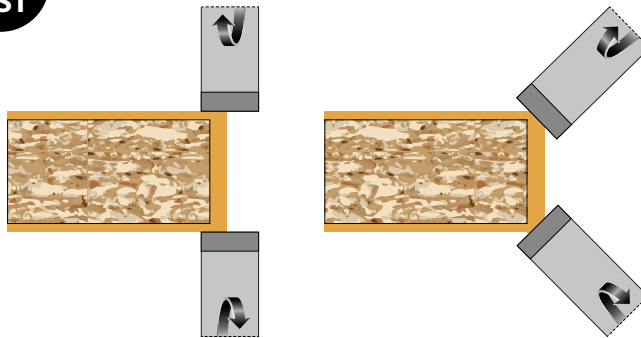
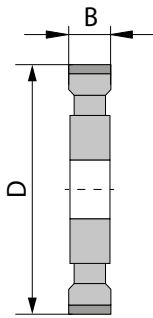

Prodotte in 4-6 taglianti, con angoli assiali per ottime finiture dei pannelli della parte eccedente del laminato rifilatore del bordo.

Produced in 4-6 teeth versions, with axial angles for optimum finish of panels requiring removal of excess laminate, edge trimmer.

Hergestellt mit 4-6 Schneiden, mit Achswinkeln für hervorragende Oberflächengüte der Platten im überstehenden Teil des Laminats mit Kantenschneider.

Se encuentran disponibles con 4-6 filos cortantes y ángulos axiales para obtener excelentes acabados de los paneles en la parte sobrante del laminado y fresado del borde.

Réalisées en 4-6 dents, avec angle axial pour des finitions optimales de la partie excédante du bord stratifié des panneaux.

Произведены с 4-6 ножами, с осевыми углами. Обработка даёт отличную отделку краев панелей и очищает от лишней кромки ламинат

# Art. D437

## Frese in diamante per bordatrice DP H2.5mm / 4.5mm

DP diamond cutters for edgebander, H 2.5 mm / 4.5 mm

Diamantfräser für Kantenanleimmaschine PKD H 2,5 mm / 4,5 mm

Fresas de diamante con placa en DP de H 2,5 mm / 4,5 mm para canteadora

Fraises en diamant pour plaqueuse de chant, DP H 2,5 mm / 4,5 mm

Фреза алмазная для кромкооблицовочного станка DP H 2.5 mm / 4.5mm



ANGOLO ASSIALE AXIAL ANGLE

0°

2,5 mm.

4,5 mm.

PRICE LIST

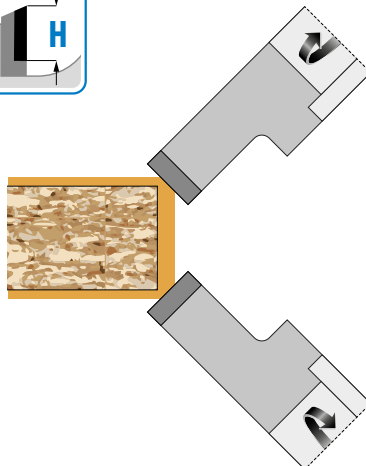
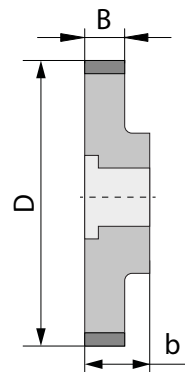

Prodotte in 4-6 taglianti, con angoli assiali per ottime finiture dei pannelli della parte eccedente del laminato rifilatore del bordo.

Produced in 4-6 teeth versions, with axial angles for optimum finish of panels requiring removal of excess laminate, edge trimmer.

Produced in 4-6 teeth versions, with axial angles for optimum finish of panels requiring removal of excess laminate, edge trimmer.

Hergestellt mit 4-6 Schneiden, mit Achswinkeln für hervorragende Oberflächengüte der Platten im überstehenden Teil des Laminats mit Kantenschneider.

Se encuentran disponibles con 4-6 filos cortantes y ángulos axiales para obtener excelentes acabados de los paneles en la parte sobrante del laminado y fresado del borde.

Réalisées en 4-6 dents, avec angle axial pour des finitions optimales de la partie excédante du bord stratifié des panneaux.

Произведены с 4-6 ножами, с осевыми углами. Обработка даёт отличную отделку краев панелей и очищает от лишней кромки ламинат



# Art. D501

## Frese in diamante per bordatrici inclinate DP H3mm

Inclined DP diamond cutters for edgebanders, H 3 mm

Diamantfräser für Kantenleimmaschinen, schräg, PKD H 3 mm

Fresas de diamante con plaquita en DP de H 3 mm para canteadoras inclinadas

Fraises en diamant pour plaqueuses de chant inclinées, DP H3 mm

Фреза алмазная для кромкооблицовочного станка под наклоном DP H3mm

Section INDEX

INDEX by article



ANGOLO ASSIALE AXIAL ANGLE

10°

3 mm.



PRICE LIST

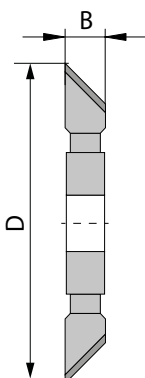

Macchina Machine	Cod. DX / RH	Cod. SX / LH	ø D mm	B mm	ø d mm	DKN	Ang. Axial	Z	rpm max
BIESSE	D501 10	D501 110	70	9	16	2 DKN	45°	4	18000
BIESSE	D501 11	D501 111	70	9	16	2 DKN	45°	6	18000
BIESSE	D501 12	D501 112	68,2	9	16	2 DKN	65°	4	18000
BIESSE	D501 13	D501 113	68,2	9	16	2 DKN	65°	6	18000

🇮🇹 Prodotte in 4-6 taglianti per ottima finitura dei pannelli nella parte eccedente del laminato con spigolatura

🇪🇸 Se encuentran disponibles con 4-6 filos cortantes para obtener un excelente acabado de los paneles en la parte sobrante del laminado con chaflán.

🇬🇧 Produced in 4-6 teeth versions, for optimum finish of panels requiring removal of excess laminate with edge-shaping

🇫🇷 Réalisées en 4-6 dents pour des finitions optimales de la partie excédante du stratifié des panneaux, avec cassage d'arête.

🇩🇪 Hergestellt mit 4-6 Schneiden für hervorragende Oberflächengüte der Platten im überstehenden Teil des Laminats mit Abkanten

🇷🇺 Произведены с 4-6 ножами; отличная отделка острых краев панелей от лишнего ламината

# Art. D502

## Frese in diamante per bordatrici inclinate DP H3mm

Inclined DP diamond cutters for edgebanders, H 3 mm

Diamantfräser für Kantenleimmaschinen, schräg, PKD H 3 mm

Fresas de diamante con plaquita en DP de H 3 mm para canteadoras inclinadas

Fraises en diamant pour plaqueuses de chant inclinées, DP H3 mm

Фреза алмазная для кромкооблицовочного станка под наклоном DP H3mm



ANGOLO ASSIALE AXIAL ANGLE

10°

3 mm.



PRICE LIST

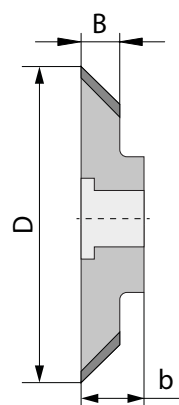

Macchina Machine	Cod. DX / RH	Cod. SX / LH	ø D mm	B mm	b mm	ø d mm	Ang. Axial	Z	rpm max
HOMAG - IMA	D502 10	D502 110	75	8	23	HSK25R	20°	4	18000
HOMAG - IMA	D502 11	D502 111	75	8	23	HSK25R	20°	6	18000
HOMAG	D502 12	D502 112	64	6	17,5	HSK32R	20°	4	18000
HOMAG	D502 13	D502 113	64	6	17,5	HSK32R	20°	6	18000
HOMAG	D502 14	D502 114	63,6	6	17,5	HSK32R	30°	4	18000
HOMAG	D502 15	D502 115	63,6	6	17,5	HSK32R	30°	6	18000
HOMAG	D502 16	D502 116	73,6	6	17,5	HSK32R	45°	4	18000
HOMAG	D502 17	D502 117	73,6	6	17,5	HSK32R	45°	6	18000

🇮🇹 Prodotte in 4-6 taglianti per ottima finitura dei pannelli nella parte eccedente del laminato con spigolatura

🇪🇸 Se encuentran disponibles con 4-6 filos cortantes para obtener un excelente acabado de los paneles en la parte sobrante del laminado con chaflán.

🇬🇧 Produced in 4-6 teeth versions, for optimum finish of panels requiring removal of excess laminate with edge-shaping

🇫🇷 Réalisées en 4-6 dents pour des finitions optimales de la partie excédante du stratifié des panneaux, avec cassage d'arête.

🇩🇪 Hergestellt mit 4-6 Schneiden für hervorragende Oberflächengüte der Platten im überstehenden Teil des Laminats mit Abkanten

🇷🇺 Произведены с 4-6 ножами; отличная отделка острых краев панелей от лишнего ламината

Section  
INDEX

DP diamond radius cutters  
for edgebanders, H3mm

Radius-Diamantfräser für  
Kantenanleimmaschinen  
PKD H 3 mm

Fresas de diamante con pla-  
quita en DP de H 3 mm para  
canteadoras radiadas

Fraises en diamant pour  
plaqueuses de chant avec  
rayons, DP H 3 mm

Алмазные фрезы для  
радиального кромкооб-  
лицовочного станка DP  
H3mm

INDEX  
by article



PRICE  
LIST

ANGOLO ASSIALE  
AXIAL ANGLE

10°

3 mm.

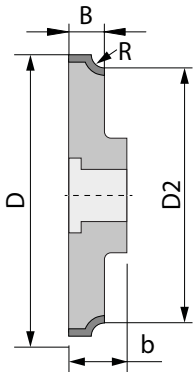

Macchina Machine	Cod. DX / RH	Cod. SX / LH	ø D mm	ø D2 mm	b mm	ø d mm	R mm	Z	rpm max
HOMAG - IMA	D504 10	D504 110	75,1	70	23	HSK25R	1	4	18000
HOMAG - IMA	D504 11	D504 111	75,1	70	23	HSK25R	1	6	18000
HOMAG - IMA	D504 12	D504 112	76,1	70	23	HSK25R	1,5	4	18000
HOMAG - IMA	D504 13	D504 113	76,1	70	23	HSK25R	1,5	6	18000
HOMAG - IMA	D504 14	D504 114	77,5	70	23	HSK25R	2	4	18000
HOMAG - IMA	D504 15	D504 115	77,5	70	23	HSK25R	2	6	18000
HOMAG - IMA	D504 16	D504 116	78,1	70	23	HSK25R	2,5	4	18000
HOMAG - IMA	D504 17	D504 117	78,1	70	23	HSK25R	2,5	6	18000
HOMAG - IMA	D504 18	D504 118	78,8	70	23	HSK25R	3	4	18000
HOMAG - IMA	D504 19	D504 119	78,8	70	23	HSK25R	3	6	18000
HOMAG - IMA	D504 20	D504 120	80	70	23	HSK25R	3,5	4	18000
HOMAG - IMA	D504 21	D504 121	80	70	23	HSK25R	3,5	6	18000
HOMAG - IMA	D504 22	D504 122	81,2	70	23	HSK25R	4	4	18000
HOMAG - IMA	D504 23	D504 123	81,2	70	23	HSK25R	4	6	18000
HOMAG - IMA	D504 24	D504 124	82,3	70	23	HSK25R	4,5	4	18000
HOMAG - IMA	D504 25	D504 125	82,3	70	23	HSK25R	4,5	6	18000
HOMAG - IMA	D504 26	D504 126	83,3	70	23	HSK25R	5	4	18000
HOMAG - IMA	D504 27	D504 127	83,3	70	23	HSK25R	5	6	18000
HOMAG	D504 28	D504 128	70	62	17,5	HSK32R	1	4	18000
HOMAG	D504 29	D504 129	70	62	17,5	HSK32R	1	6	18000
HOMAG	D504 30	D504 130	69	62	17,5	HSK32R	1,5	4	18000
HOMAG	D504 31	D504 131	69	62	17,5	HSK32R	1,5	6	18000
HOMAG	D504 32	D504 132	69	62	17,5	HSK32R	2	4	18000
HOMAG	D504 33	D504 133	69	62	17,5	HSK32R	2	6	18000
HOMAG	D504 34	D504 134	69	62	17,5	HSK32R	2,5	4	18000
HOMAG	D504 35	D504 135	69	62	17,5	HSK32R	2,5	6	18000
HOMAG	D504 36	D504 136	69	62	17,5	HSK32R	3	4	18000
HOMAG	D504 37	D504 137	69	62	17,5	HSK32R	3	6	18000
HOMAG	D504 38	D504 138	72	62	17,5	HSK32R	3,5	4	18000
HOMAG	D504 39	D504 139	72	62	17,5	HSK32R	3,5	6	18000
HOMAG	D504 40	D504 140	72	62	17,5	HSK32R	4	4	18000
HOMAG	D504 41	D504 141	72	62	17,5	HSK32R	4	6	18000
HOMAG	D504 42	D504 142	72	62	17,5	HSK32R	4,5	4	18000
HOMAG	D504 43	D504 143	72	62	17,5	HSK32R	4,5	6	18000
HOMAG	D504 44	D504 144	72	62	17,5	HSK32R	5	4	18000
HOMAG	D504 45	D504 145	72	62	17,5	HSK32R	5	6	18000

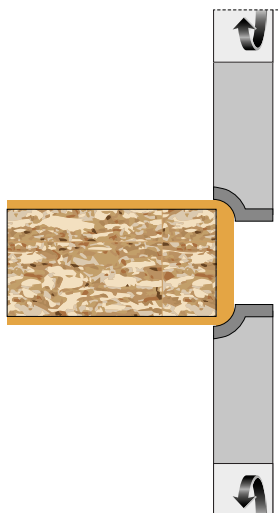

🇮🇹 Prodotte in 4-6 taglianti con angoli assiali per ottima finitura nella lavorazione di pannelli bordati in materie plastiche e legno massiccio

🇬🇧 Produced in 4-6 teeth versions, with axial angles designed to give optimum finish when machining panels edged with plastics and solid wood

🇩🇪 Hergestellt mit 4-6 Schneiden mit Achswinkeln für hervorragende Oberflächengüte bei der Bearbeitung von Platten mit Kunststoff- und Vollholzkanten

🇪🇸 Se encuentran disponibles con 4-6 filos cortantes y ángulos axiales para obtener un excelente acabado de los paneles canteados de material plástico y madera maciza

🇫🇷 Réalisées en 4-6 dents avec angle axial pour les finitions optimales dans l'usage de panneaux recouverts de matières plastique et bois massif.

🇷🇺 Произведены с 4-6 ножами с осевыми углами; отличная отделка при обработке кромки панелей из пластика и для обработок массива дерева.

# Art. D503

## Frese in diamante per bordatrici raggate DP H3mm

DP diamond radius cutters for edgebanders, H3mm

Radius-Diamantfräser für Kantenanleimmaschinen PKD H 3 mm

Fresas de diamante con plaquita en DP de H 3 mm para canteadoras radiadas

Fraises en diamant pour plaqueuses de chant avec rayons, DP H 3 mm

Алмазные фрезы для радиального кромкооблицовочного станка DP H3mm

Section INDEX

INDEX by article



ANGOLO ASSIALE AXIAL ANGLE  
**10°**

**3 mm.**

Macchina Machine	Cod. DX / RH	Cod. SX / LH	ø D mm	ø D2 mm	b mm	ø d mm	R mm.	DKN	Z	rpm max
BIESSE	D503 10	D503 110	67	60	23	16	1	2 DKN	6	18000
BIESSE	D503 11	D503 111	68	60	23	16	2	2 DKN	6	18000
BIESSE	D503 12	D503 112	70	60	23	16	3	2 DKN	6	18000
BRANDT	D503 13	D503 113	69	61	17,5	16	2	2 DKN	4	18000
BRANDT	D503 14	D503 114	69	61	17,5	16	2	2 DKN	6	18000
BRANDT	D503 15	D503 115	69	61	17,5	16	3	2 DKN	4	18000
BRANDT	D503 16	D503 116	69	61	17,5	16	3	2 DKN	6	18000

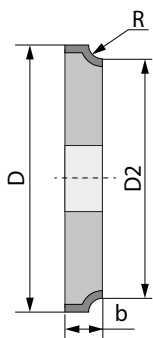

PRICE LIST

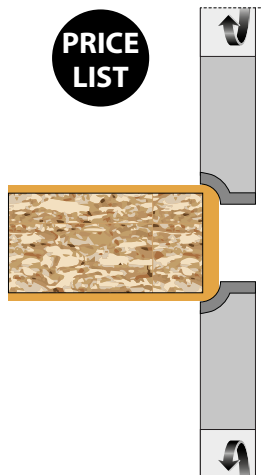

Prodotte in 4-6 taglianti con angoli assiali per ottima finitura nella lavorazione di pannelli bordati in materie plastiche e legno massiccio

Produced in 4-6 teeth versions, with axial angles designed to give optimum finish when machining panels edged with plastics and solid wood

Hergestellt mit 4-6 Schneiden mit Achswinkeln für hervorragende Oberflächengüte bei der Bearbeitung von Platten mit Kunststoff- und Vollholzkanten

Se encuentran disponibles con 4-6 filos cortantes y ángulos axiales para obtener un excelente acabado de los paneles canteados de material plástico y madera maciza

Réalisées en 4-6 dents avec angle axial pour les finitions optimales dans l'usinage de panneaux recouverts de matières plastique et bois massif.

Произведены с 4-6 ножами с осевыми углами; отличная отделка при обработке кромки панелей из пластика и для обработок массива дерева.

# Art. D505

## Frese in diamante per bordatrici raggate DP H3mm

DP diamond radius cutters for edgebanders, H3mm

Radius-Diamantfräser für Kantenanleimmaschinen PKD H 3 mm

Fresas de diamante con plaquita en DP de H 3 mm para canteadoras radiadas

Fraises en diamant pour plaqueuses de chant avec rayons, DP H 3 mm

Алмазные фрезы для радиального кромкооблицовочного станка DP H3mm

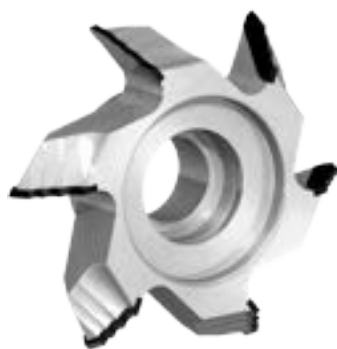

ANGOLO ASSIALE AXIAL ANGLE  
**10°**

**3 mm.**

Macchina Machine	Cod. DX / RH	Cod. SX / LH	ø D mm	ø D2 mm	b mm	ø d mm	R mm.	R1 mm.	R2 mm.	Z	rpm max
HOMAG	D505 10	D505 110	81,1	70	28	HSK25R	3	2		4	18000
HOMAG	D505 11	D505 111	81,1	70	28	HSK25R	3	2		6	18000
HOMAG	D505 12	D505 112	81,1	70	28	HSK25R	1,5	2	3	4	18000
HOMAG	D505 13	D505 113	81,1	70	28	HSK25R	1,5	2	3	6	18000

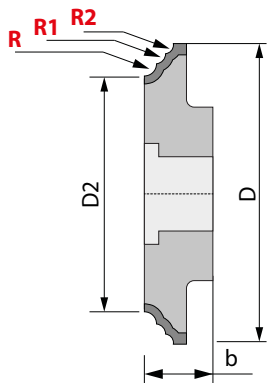

PRICE LIST

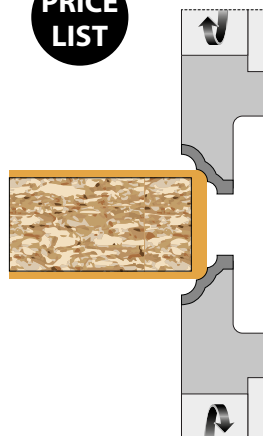

Prodotte in 4-6 taglianti con angoli assiali per ottima finitura nella lavorazione di pannelli bordati in materie plastiche e legno massiccio

Produced in 4-6 teeth versions, with axial angles designed to give optimum finish when machining panels edged with plastics and solid wood

Hergestellt mit 4-6 Schneiden mit Achswinkeln für hervorragende Oberflächengüte bei der Bearbeitung von Platten mit Kunststoff- und Vollholzkanten

Se encuentran disponibles con 4-6 filos cortantes y ángulos axiales para obtener un excelente acabado de los paneles canteados de material plástico y madera maciza

Réalisées en 4-6 dents avec angle axial pour les finitions optimales dans l'usinage de panneaux recouverts de matières plastique et bois massif.

Произведены с 4-6 ножами с осевыми углами; отличная отделка при обработке кромки панелей из пластика и для обработок массива дерева.

Section  
**INDEX**

DP diamond anti-splinter head with reversible knives for edgebander, H3mm, 45° axial angle

Diamant-Fügefräser für Kantenanleimmaschine mit Wendeschneidplatten PKD H 3 mm, Achswinkel 45°

Cabezal de diamante antiastillante con cuchillas desechables, plaquita en DP de H 3 mm y ángulos axiales de 45° para canteadora

P.O. anti éclat pour plaques de chant avec plaquettes à jeter, DP H3 mm, axialité 45°

Фреза алмазная (анти-сколов) со сменными ножами для кромкооблицовочного станка DP H3мм, угол 45°

**INDEX**  
by article

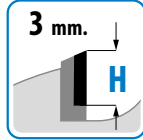

**PRICE LIST**

Testa antischeggia per lavorazione di pannelli di truciolare e nobilitati costruite con corpo in lega speciale Ergal, Z=2/3 taglienti a gettare, riaffilabili DP H3mm, assialità 45°, simmetrica ed asimmetrica.

DP diamond anti-splinter head for machining particleboard and laminated panels with body made of special Ergal alloy, Z=2/3, sharpenable reversible knives, H3mm, 45° axial angle, symmetrical and asymmetrical.

Diamant-Fügefräser für die Bearbeitungen von Spanplatten und beschichteten Platten, mit Körper aus Speziallegierung Ergal, Z=2/3 Wechselschneiden, nachschleifbar, PKD H 3 mm, Achswinkel 45°, symmetrisch und asymmetrisch.

Cabezal antiastillante para mecanizar paneles de aglomerado y melamina. Cuenta con cuerpo de aleación especial Ergal, Z=2/3, cuchillas desechables o reafilables, plaquita en DP de H 3 mm, ángulos axiales de 45°, diseño simétrico y asimétrico.

P.O. anti éclat pour l'usinage de panneaux aggloméré et anoblis, construits avec corps en alliage spécial Ergal, Z2/3 plaquettes, réaffûtable, DP H3 mm, axialité 45°, symétrique et asymétrique.

Фреза (анти-сколов) для обработки ДСП и панелей с покрытием. Корпус со специального сплава Ergal, Z=2/3 ножи сменные, затачиваемые DP H3мм, угол 45°, ассиметричные и симметричные.

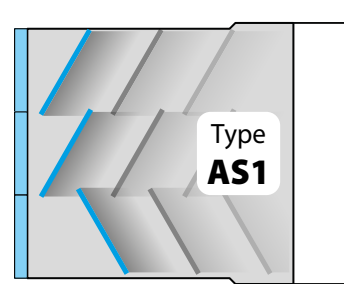
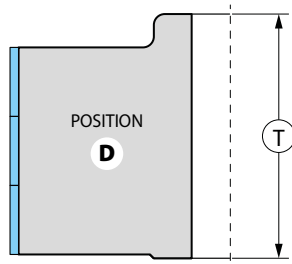
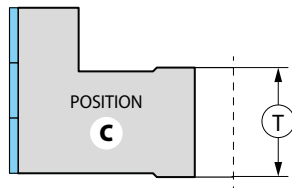
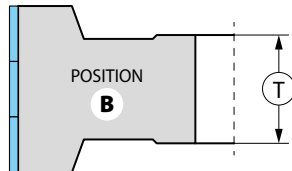
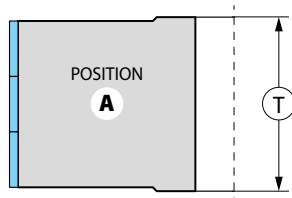

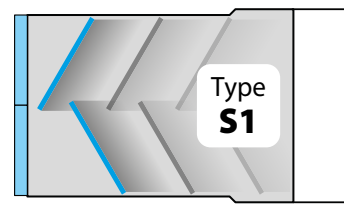

**AS1**  
DISPOSIZIONE ASIMMETRICA  
ASYMMETRIC TIP ARRANGEMENT



**S1**  
DISPOSIZIONE SIMMETRICA  
SYMMETRIC TIP ARRANGEMENT

Macchina Machine	Cod. DX / RH	Cod. SX / LH	ø D mm	B mm	T	ø d mm	DKN	Forma Form	Tipo Type	Z	rpm max
SCM	D307 10	D307 110	100	56	60	30	2DKN	C	AS1	2 x 6 (12)	18000
SCM	D307 11	D307 111	100	56	60	30	2DKN	C	AS1	3 x 7 (21)	18000
SCM	D307 12	D307 112	100	65	60	30	2DKN	C	AS1	2 x 7 (14)	18000
SCM	D307 13	D307 113	100	65	60	30	2DKN	C	AS1	3 x 7 (21)	18000
STEFANI	D307 14	D307 114	100	56	60	30	2DKN	C	AS1	2 x 6 (12)	18000
STEFANI	D307 15	D307 115	100	56	60	30	2DKN	C	AS1	3 x 6 (18)	18000
STEFANI	D307 16	D307 116	100	65	60	30	2DKN	C	AS1	2 x 7 (14)	18000
STEFANI	D307 17	D307 117	100	65	60	30	2DKN	C	AS1	3 x 7 (21)	18000
BIESSE	D307 18	D307 118	80	47	53	30	2DKN	A	S1	2 x 5 (10)	18000
BIESSE	D307 19	D307 119	80	65	53	30	2DKN	B	S1	2 x 7 (14)	18000
BIESSE	D307 20	D307 120	100	47	75	30	2DKN	A	S1	3 x 5 (15)	18000
BIESSE	D307 21	D307 121	100	65	75	30	2DKN	A	S1	3 x 7 (21)	18000
BIESSE	D307 22	D307 122	125	47	40	30	2DKN	B	S1	3 x 5 (15)	15000
BIESSE	D307 23	D307 123	125	65	40	30	2DKN	B	S1	3 x 7 (21)	15000
BIESSE	D307 24	D307 124	125	47	40	30	2DKN	B	S1	3 x 5 (15)	15000
BIESSE	D307 25	D307 125	125	65	40	30	2DKN	B	S1	3 x 7 (21)	15000
HOMAG	D307 26	D307 126	125	47	40	30	2DKN	B	S1	3 x 5 (15)	15000
HOMAG	D307 27	D307 127	125	65	40	30	2DKN	B	S1	3 x 7 (21)	15000
HOMAG	D307 28	D307 128	125	47	40	30	2DKN	B	S1	3 x 5 (15)	15000
IMA	D307 29	D307 129	125	38	36	30	2DKN	A	AS1	3 x 4 (12)	15000
IMA	D307 30	D307 130	125	47	42	30	2DKN	B	AS1	3 x 5 (15)	15000
IMA	D307 31	D307 131	125	65	42	30	2DKN	C	AS1	3 x 7 (21)	15000
IMA	D307 32	D307 132	125	47	40	30	2DKN	C	AS1	3 x 5 (15)	15000
IMA	D307 33	D307 133	125	65	40	30	2DKN	C	AS1	3 x 7 (21)	15000
IMA ADVANTAGE	D307 34	D307 134	125	47	57	30	2DKN	D	AS1	3 x 5 (15)	15000
IMA ADVANTAGE	D307 35	D307 135	125	65	57	30	2DKN	D	AS1	3 x 7 (21)	15000
BRAND	D307 36	D307 136	100	47	40,5	30	2DKN	C	AS1	2 x 5 (10)	18000
BRAND	D307 37	D307 137	100	47	40,5	30	2DKN	C	AS1	3 x 5 (15)	18000
BRAND	D307 38	D307 138	100	65	40,5	30	2DKN	C	AS1	3 x 7 (21)	18000
BRAND	D307 39	D307 139	100	85	85	30	2DKN	C	AS1	3 x 9 (27)	18000
BRAND	D307 40	D307 140	100	105	85	30	2DKN	C	AS1	3 x 12 (36)	18000
CEHISA	D307 41	D307 141	100	56	25	20	2DKN	B	AS1	2 x 6 (12)	18000
FELDER	D307 42	D307 142	60	65	63	25	2DKN	C	AS1	2 x 7 (14)	18000
FELDER	D307 43	D307 143	80	47	64	25	2DKN	D	AS1	3 x 5 (15)	18000
FELDER	D307 44	D307 144	80	65	64	25	2DKN	C	AS1	3 x 7 (21)	18000
FRAVOL	D307 45	D307 145	60	65	63	25	2DKN	C	AS1	2 x 7 (14)	18000
FRAVOL	D307 46	D307 146	80	85	61	25	2DKN	C	AS1	2 x 9 (18)	18000
FRAVOL	D307 47	D307 147	100	65	56	30	2DKN	C	AS1	2 x 7 (14)	18000
FRAVOL	D307 48	D307 148	100	124	96	30	2DKN	B	AS1	2 x 12 (24)	18000
TORK MACHINE	D307 49	D307 149	100	65	40	30	2DKN	C	AS1	3 x 7 (21)	18000
OTT	D307 50	D307 150	85	47	50	30	2DKN	C	AS1	3 x 5 (15)	18000
OTT	D307 51	D307 151	85	65	45	30	2DKN	C	AS1	3 x 7 (21)	18000
OTT	D307 52	D307 152	85	85	50	30	2DKN	C	AS1	3 x 9 (27)	18000
HOLZ-HER 1801-1802	D307 53	D307 153	70	47	41	30	2DKN	B	AS1	2 x 5 (10)	18000
HOLZ-HER 1801-1802	D307 54	D307 154	70	65	41	30	2DKN	B	AS1	2 x 7 (14)	18000
HOLZ-HER 1804	D307 55	D307 155	100	65	39	30	2DKN	B	S1	3 x 7 (21)	18000
HOLZ-HER 1891	D307 56	D307 156	100	47	25	30	2DKN	B	AS1	2 x 5 (10)	18000
HOLZ-HER 1891	D307 57	D307 157	100	65	25	30	2DKN	B	AS1	2 x 7 (14)	18000
Hebrock EBM	D307 58	D307 158	70	47	61	25	2DKN	D	AS1	2 x 5 (10)	18000
Hebrock EBM	D307 59	D307 159	70	65	81	25	2DKN	D	AS1	2 x 7 (14)	18000
Hebrock EBM	D307 60	D307 160	100	47	61	30	2DKN	C	AS1	2 x 5 (10)	18000
Hebrock EBM	D307 61	D307 161	100	65	81	30	2DKN	C	AS1	2 x 7 (14)	18000

Cod.		Parti di ricambio - Spare Partes	Dimensions mm
D307 80		Coltello / Knife	16 x 15 x 5
VT 5 x 7 torx		Vite / Screw	VT 5 x 7 torx
CH T20 torx		Chiave / Allen key	T20 torx

Section INDEX

Anti-splinter DP diamond cutter for edgebander, H2.5mm, 20°/30° axial angles

Diamant-Fügefräser für Kantenanleimmaschine PKD H 2,5 mm, Achswinkel 20°/30°

Fresa de diamante antiastillante con plaquita en DP de H 2,5 mm y ángulos axiales de 20°/30° para canteadora

Fraise en diamant anti éclat pour plaqueuse de chant, DP H 2,5 mm avec angle axial 20°/30°

Алмазная фреза (анти-сколов) для кромкооблицовочного станка DP H2.5mm осевые углы 20°/30°

INDEX by article

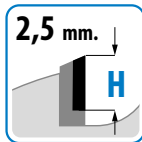
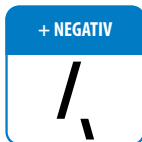

PRICE LIST

Costruite con corpo in acciaio speciale Z=2+2/3+3 DP H2.5mm, assialità 20°/30°, disegno asimmetrico e simmetrico, per ottenere un'ottima qualità di lavorazione, finitura e scarico del truciolo

Manufactured with body of special steel, Z=2+2/3+3, DP, H2.5mm, 20°/30° axial angles, asymmetrical and symmetrical pattern, to give optimum quality of machining, finishing and chip removal

Hergestellt mit Körper aus Sonderstahl Z=2+2/3+3 PKD H 2,5 mm, Achswinkel 20°/30°, asymmetrisches und symmetrisches Design, für eine hervorragende Bearbeitungsqualität, Oberflächen-güte und Spanabfuhr

Cuenta con cuerpo de acero especial Z=2+2/3+3 con plaquita en DP de H 2,5 mm, ángulos axiales de 20°/30°, diseño asimétrico y simétrico, para obtener una excelente calidad de mecanizado, acabado y descarga de la viruta.

Construite avec corps en acier spécial en Z2+2/3+3, DP H 2,5 mm, axialité 20/30°, dessin symétrique et asymétrique pour obtenir une qualité d'usinage optimale, finition et écoulement du copeau.

Корпус из специальной стали Z=2+2/3+3 DP H2.5mm, угол 20°/30°, асимметричный и симметричный дизайн позволяет получить отличное качество обработки, отделки и удаления стружки

### DIAMETER 60 ANGLE AXIAL 20°

Macchina Machine	Cod. DX / RH	Cod. SX / LH	ø D mm	B mm	ø d mm	DKN	See drawings pag. 106				AS1 S1	Type	Z	Z Tot	rpm max
							A	A1	T	C					
CEHISA	D401 10	D401 210	60	36	20	2 DKN	6,5		43,5		AS1	6	2+2	8	18000
CEHISA	D401 11	D401 211	60	36	20	2 DKN	6,5		43,5		AS1	6	3+3	12	18000
FRAVOL	D401 12	D401 212	60	48	25	2 DKN					AS1	1	2+2	12	18000
FRAVOL	D401 13	D401 213	60	48	25	2 DKN					AS1	1	3+3	18	18000
FELDER	D401 14	D401 214	60	48	25	2 DKN	14				AS1	6	2+2	12	18000
FELDER	D401 15	D401 215	60	48	25	2 DKN	14				AS1	6	3+3	18	18000
	D401 16	D401 216	60	48	20	2 DKN	7				AS1	7	2+2	12	18000
	D401 17	D401 217	60	48	20	2 DKN	7				AS1	7	3+3	18	18000
	D401 18	D401 218	60	55	20	2 DKN					AS1	1	2+2	14	18000
	D401 19	D401 219	60	55	20	2 DKN					AS1	1	3+3	21	18000
	D401 20	D401 220	60	55	25	2 DKN					AS1	1	2+2	14	18000
	D401 21	D401 221	60	55	25	2 DKN					AS1	1	3+3	21	18000
	D401 22	D401 222	60	55	16	2 DKN	12		31		S1	2	2+2	14	18000
	D401 23	D401 223	60	55	16	2 DKN	12		31	12	S1	2	3+3	21	18000
CEHISA	D401 24	D401 224	60	55	20	2 DKN	13		43,5	12	AS1	7	2+2	14	18000
CEHISA	D401 25	D401 225	60	55	20	2 DKN	13		43,5		AS1	7	3+3	21	18000
	D401 26	D401 226	60	55	20	2 DKN					AS1	1	2+2	16	18000
	D401 27	D401 227	60	65	20	2 DKN					AS1	1	3+3	24	18000
FELDER format 4 - FRAVOL	D401 28	D401 228	60	65	25	2 DKN					AS1	1	2+2	16	18000
FELDER format 4 - FRAVOL	D401 29	D401 229	60	65	25	2 DKN					AS1	1	3+3	24	18000
	D401 30	D401 230	60	65	25	2 DKN	8				AS1	7	2+2	16	18000
	D401 31	D401 231	60	65	25	2 DKN	8				AS1	7	3+3	24	18000

### DIAMETER 70 ANGLE AXIAL 20°

Macchina Machine	Cod. DX / RH	Cod. SX / LH	ø D mm	B mm	ø d mm	DKN	See drawings pag. 106				AS1 S1	Type	Z	Z Tot	rpm max
							A	A1	T	C					
	D401 32	D401 232	70	45	30	2 DKN	16				AS1	6	2+2	12	18000
	D401 33	D401 233	70	45	30	2 DKN	16				AS1	6	3+3	18	18000
HOLZ-HER	D401 34	D401 234	70	48	30	2 DKN	9	9	24	6	AS1	10	2+2	12	18000
HOLZ-HER	D401 35	D401 235	70	48	30	2 DKN	9	9	24	6	AS1	10	3+3	18	18000
HOLZ-HER - ARCUS 1801	D401 36	D401 236	70	48	30	2 DKN	9		41	6	AS1	2	2+2	12	18000
HOLZ-HER - ARCUS 1801	D401 37	D401 237	70	48	30	2 DKN	9		41	6	AS1	2	3+3	18	18000
	D401 38	D401 238	70	48	30	2 DKN	8				AS1	7	2+2	12	18000
	D401 39	D401 239	70	48	30	2 DKN	8				AS1	7	3+3	18	18000
Hebrock	D401 40	D401 240	70	48	25	2 DKN	12		61		AS1	6	2+2	12	18000
Hebrock	D401 41	D401 241	70	48	25	2 DKN	12		61		AS1	6	3+3	18	18000
	D401 42	D401 242	70	48	25	2 DKN	11		70	11	AS1	3	2+2	12	18000
	D401 43	D401 243	70	48	25	2 DKN	11		70	11	AS1	3	3+3	18	18000
HOLZ-HER aggregate 1801	D401 44	D401 244	70	55	30	2 DKN	9,5	9	30,5	6	AS1	10	2+2	14	18000
HOLZ-HER aggregate 1801	D401 45	D401 245	70	55	30	2 DKN	9,5	9	30,5	6	AS1	10	3+3	21	18000
HOLZ-HER - ARCUS 1801	D401 46	D401 246	70	65	30	2 DKN	9,5	9	40,5	6	AS1	10	2+2	16	18000
HOLZ-HER - ARCUS 1801	D401 47	D401 247	70	65	30	2 DKN	9,5	9	40,5	6	AS1	10	3+3	24	18000

## DIAMETER 80 ANGLE AXIAL 30°

Macchina Machine	Cod. DX / RH	Cod. SX / LH	ø D mm	B mm	ø d mm	DKN	See drawings pag. 106					Z	Z Tot	rpm max	
							A	A1	T	C	AS1 S1				Type
	D401 48	D401 248	80	25	30	2 DKN					AS1	1	2 + 2	6	18000
	D401 49	D401 249	80	25	30	2 DKN					AS1	1	3 + 3	9	18000
AKRON 1300 / 1400 AKRON 400 / 800 ROXYL - STREMA BIESSE - JADE 240	D401 50	D401 250	80	30	30	2 DKN	11,5		53	11,5	S1	3	2 + 2	8	18000
AKRON 1300 / 1400 AKRON 400 / 800 ROXYL - STREMA BIESSE - JADE 240	D401 51	D401 251	80	30	30	2 DKN	11,5		53	11,5	S1	3	3 + 3	12	18000
SCM	D401 52	D401 252	80	40	30	2 DKN					AS1	1	2 + 2	10	18000
SCM	D401 53	D401 253	80	40	30	2 DKN					AS1	1	3 + 3	15	18000
AKRON 1300 / 1400 AKRON 400 / 800 ROXYL - STREMA BIESSE - JADE 240	D401 54	D401 254	80	45	30	2 DKN	4		53	4	S1	3	2 + 2	12	18000
AKRON 1300 / 1400 AKRON 400 / 800 ROXYL - STREMA BIESSE - JADE 240	D401 55	D401 255	80	45	30	2 DKN	4		53	4	S1	3	3 + 3	18	18000
	D401 56	D401 256	80	48	30	2 DKN					AS1	1	2 + 2	12	18000
	D401 57	D401 257	80	48	30	2 DKN					AS1	1	3 + 3	18	18000
FELDER	D401 58	D401 258	80	48	30	2 DKN	15		63		AS1	6	2 + 2	12	18000
FELDER	D401 59	D401 259	80	48	30	2 DKN	15		63		AS1	6	3 + 3	18	18000
BIESSE AK - RON 246	D401 60	D401 260	80	48	20	2 DKN	11,5		25	11,5	S	2	2 + 2	12	18000
BIESSE AK - RON 246	D401 61	D401 261	80	48	20	2 DKN	11,5		25	11,5	S	2	3 + 3	18	18000
SCM ME-35 - MINIMAX	D401 62	D401 262	80	55	30	2 DKN					AS1	1	2 + 2	14	18000
SCM ME-35 - MINIMAX	D401 63	D401 263	80	55	30	2 DKN					AS1	1	3 + 3	21	18000
BIESSE AK RON 246 GRIGGIO	D401 64	D401 264	80	55	20	2 DKN	17		25	13	AS1	2	2 + 2	14	18000
BIESSE AK RON 246 GRIGGIO	D401 65	D401 265	80	55	20	2 DKN	17		25	13	AS1	2	3 + 3	21	18000
	D401 66	D401 266	80	65	25	2 DKN					AS1	1	2 + 2	16	18000
	D401 67	D401 267	80	65	25	2 DKN					AS1	1	3 + 3	24	18000
AKRON 1300 / 1400 AKRON 400 / 800 ROXYL - STREMA BIESSE - JADE 240	D401 68	D401 268	80	65	30	2 DKN	6		53	6	S1	2	2 + 2	16	18000
AKRON 1300 / 1400 AKRON 400 / 800 ROXYL - STREMA BIESSE - JADE 240	D401 69	D401 269	80	65	30	2 DKN	6		53	6	S1	2	3 + 3	24	18000
	D401 70	D401 270	80	65	30	2 DKN	10		56		AS1	7	2 + 2	16	18000
	D401 71	D401 271	80	65	30	2 DKN	10		56		AS1	7	3 + 3	24	18000
GRIGGIO	D401 72	D401 272	80	65	30	2 DKN	28		25	12	AS1	2	2 + 2	16	18000
GRIGGIO	D401 73	D401 273	80	65	30	2 DKN	28		25	12	AS1	2	3 + 3	24	18000
CEHISA	D401 74	D401 274	80	65	20	2 DKN	21,5		37	6,5	AS1	2	2 + 2	16	18000
CEHISA	D401 75	D401 275	80	65	20	2 DKN	21,5		37	6,5	AS1	2	3 + 3	24	18000

## DIAMETER 85 ANGLE AXIAL 30°

Macchina Machine	Cod. DX / RH	Cod. SX / LH	ø D mm	B mm	ø d mm	DKN	See drawings pag. 106					Z	Z Tot	rpm max	
							A	A1	T	C	AS1 S1				Type
OTT	D401 76	D401 276	85	45	30	2 DKN					AS1	1	3 + 3	24	18000
OTT	D401 77	D401 277	85	65	30	2 DKN	15				AS1	7	3 + 3	24	18000



## DIAMETER 100

## ANGLE AXIAL 30°

Macchina Machine	Cod. DX / RH	Cod. SX / LH	ø D mm	B mm	ø d mm	DKN	See drawings pag. 106				AS1 S1	Type	Z	Z Tot	rpm max
							A	A1	T	C					
IMA - BRANDT	D401 78	D401 278	100	35	30	2 DKN					S1	1	2 + 2	8	18000
IMA - BRANDT	D401 79	D401 279	100	35	30	2 DKN					S1	1	3 + 3	12	18000
	D401 80	D401 280	100	45	30	2 DKN					AS1	1	2 + 2	12	18000
	D401 81	D401 281	100	45	30	2 DKN					AS1	1	3 + 3	18	18000
	D401 82	D401 282	100	45	30	2 DKN					S1	1	2 + 2	12	18000
	D401 83	D401 283	100	45	30	2 DKN					S1	1	3 + 3	18	18000
BRANDT	D401 84	D401 284	100	45	30	2 DKN	5,4		40,6		AS1	7	2 + 2	12	18000
BRANDT	D401 85	D401 285	100	45	30	2 DKN	5,4		40,6		AS1	7	3 + 3	18	18000
HEBROCK - EBM - BRANDT AMBITION - 1110 F	D401 86	D401 286	100	45	30	2 DKN	16		61		AS1	6	2 + 2	12	18000
HEBROCK - EBM - BRANDT AMBITION - 1110 F	D401 87	D401 287	100	45	30	2 DKN	16		61		AS1	6	3 + 3	18	18000
	D401 88	D401 288	100	45	30	2 DKN	12		75	15	AS1	3	2 + 2	12	18000
	D401 89	D401 289	100	45	30	2 DKN	12		75	15	AS1	3	3 + 3	18	18000
	D401 90	D401 290	100	48	25	2 DKN					AS1	1	2 + 2	12	18000
	D401 91	D401 291	100	48	25	2 DKN					AS1	1	3 + 3	18	18000
HOLZ-HER - UPTO 2008 . SCM	D401 92	D401 292	100	48	30	2 DKN	11,5		25	11,5	AS1	2	2 + 2	12	18000
HOLZ-HER - UPTO 2008 . SCM	D401 93	D401 293	100	48	30	2 DKN	11,5		25	11,5	AS1	2	3 + 3	18	18000
BRANDT - IMA - SCM K360 - K560 - IDM - BIESSE	D401 94	D401 294	100	48	30	2 DKN	7,4		40,6		AS1	7	2 + 2	12	18000
BRANDT - IMA - SCM K360 - K560 - IDM - BIESSE	D401 95	D401 295	100	48	30	2 DKN	7,4		40,6		AS1	7	3 + 3	18	18000
BRANDT - IMA - SCM K360 - K560 - IDM - BIESSE	D401 96	D401 296	100	48	30	2 DKN	4		40	4	AS1	2	2 + 2	12	18000
BRANDT - IMA - SCM K360 - K560 - IDM - BIESSE	D401 97	D401 297	100	48	30	2 DKN	4		40	4	AS1	2	3 + 3	18	18000
	D401 98	D401 298	100	55	30	2 DKN					AS1	1	2 + 2	14	18000
	D401 99	D401 299	100	55	30	2 DKN					AS1	1	3 + 3	21	18000
HOLZ-HER UP TO 2008 - SCM	D401 100	D401 300	100	55	30	2 DKN	18,5		25	11,5	AS1	2	2 + 2	14	18000
HOLZ-HER UP TO 2008 - SCM	D401 101	D401 301	100	55	30	2 DKN	18,5		25	11,5	AS1	2	3 + 3	21	18000
BRANDT - IMA - SCM K360 - K560 - IDM - BIESSE	D401 102	D401 302	100	55	30	2 DKN	14,4		40,6		AS1	7	2 + 2	14	18000
BRANDT - IMA - SCM K360 - K560 - IDM - BIESSE	D401 103	D401 303	100	55	30	2 DKN	14,4		40,6		AS1	7	3 + 3	21	18000
	D401 104	D401 304	100	65	30	2 DKN					AS1	1	2 + 2	16	18000
	D401 105	D401 305	100	65	30	2 DKN					AS1	1	3 + 3	24	18000
BIESSE AKRON 600 - AKRON 800	D401 106	D401 306	100	65	30	2 DKN	5		75	5	S1	3	2 + 2	16	18000
BIESSE AKRON 600 - AKRON 800	D401 107	D401 307	100	65	30	2 DKN	5		75	5	S1	3	3 + 3	24	18000
BRANDT - IMA - SCM K360 - K560 - IDM - BIESSE	D401 108	D401 308	100	65	30	2 DKN	25,4		40,6		AS1	7	2 + 2	16	18000
BRANDT - IMA - SCM K360 - K560 - IDM - BIESSE	D401 109	D401 309	100	65	30	2 DKN	25,4		40,6		AS1	7	3 + 3	24	18000
HOLZ-HER UP TO 2008 - SCM	D401 110	D401 310	100	65	30	2 DKN	12		26	27	AS1	2	2 + 2	16	18000
HOLZ-HER UP TO 2008 - SCM	D401 111	D401 311	100	65	30	2 DKN	12		26	27	AS1	2	3 + 3	24	18000
CEHISA	D401 112	D401 312	100	65	20	2 DKN	21,5		37	6,5	AS1	2	2 + 2	16	18000
CEHISA	D401 113	D401 313	100	65	20	2 DKN	21,5		37	6,5	AS1	2	3 + 3	24	18000
HOLZ-HER	D401 114	D401 314	100	65	30	2 DKN	16		40	9	AS1	2	2 + 2	16	18000
HOLZ-HER	D401 115	D401 315	100	65	30	2 DKN	16		40	9	AS1	2	3 + 3	24	18000



## DIAMETER 125 ANGLE AXIAL 30°

Macchina Machine	Cod. DX / RH	Cod. SX / LH	ø D mm	B mm	ø d mm	DKN	See drawings pag. 106				AS1 S1	Type	Z	Z Tot	rpm max
							A	A1	T	C					
IMA - HOMAG	D401 116	D401 316	125	34	30	2 DKN					AS1	1	3 + 3	12	15000
IMA - HOMAG	D401 117	D401 317	125	34	30	2 DKN					AS1	1	4 + 4	16	15000
	D401 118	D401 318	125	43	30	2 DKN	14		57		AS1	6	3 + 3	18	15000
	D401 119	D401 319	125	43	30	2 DKN	14		57		AS1	6	4 + 4	24	15000
IMA - BIESSE	D401 120	D401 320	125	45	30	2 DKN					AS1	1	3 + 3	18	15000
IMA - BIESSE	D401 121	D401 321	125	45	30	2 DKN					AS1	1	4 + 4	24	15000
HOMAG - BIESSE	D401 122	D401 322	125	45	30	2 DKN	6				AS1	7	3 + 3	18	15000
HOMAG - BIESSE	D401 123	D401 323	125	45	30	2 DKN	6				AS1	7	4 + 4	24	15000
BIESSE	D401 124	D401 324	125	48	30	2 DKN					AS1	1	3 + 3	18	15000
BIESSE	D401 125	D401 325	125	48	30	2 DKN					AS1	1	4 + 4	24	15000
HOMAG	D401 126	D401 326	125	48	30	2 DKN	4		40	4	AS1	2	3 + 3	18	15000
HOMAG	D401 127	D401 327	125	48	30	2 DKN	4		40	4	AS1	2	4 + 4	24	15000
	D401 128	D401 328	125	65	30	2 DKN					AS1	1	3 + 3	24	15000
	D401 129	D401 329	125	65	30	2 DKN					AS1	1	4 + 4	32	15000
BIESSE	D401 130	D401 330	125	65	30	2 DKN	8		49	8	AS1	2	3 + 3	24	15000
BIESSE	D401 131	D401 331	125	65	30	2 DKN	8		49	8	AS1	2	4 + 4	32	15000
BRANDT - IMA - SCM IDM - BIESSE	D401 132	D401 332	125	65	30	2 DKN	25,4		40,6		AS1	7	3 + 3	24	15000
BRANDT - IMA - SCM IDM - BIESSE	D401 133	D401 333	125	65	30	2 DKN	25,4		40,6		AS1	7	4 + 4	32	15000
HOMAG	D401 134	D401 334	125	65	30	2 DKN	12,5		40	12,5	AS1	2	3 + 3	24	15000
HOMAG	D401 135	D401 335	125	65	30	2 DKN	12,5		40	12,5	AS1	2	4 + 4	32	15000
GRIGGIO - HOLZ-HER	D401 136	D401 336	125	65	30	2 DKN	28		25	12	AS1	2	3 + 3	24	15000
GRIGGIO - HOLZ-HER	D401 137	D401 337	125	65	30	2 DKN	28		25	12	AS1	2	4 + 4	32	15000

Section  
INDEX

INDEX  
by article

## DIAMETER 150 ANGLE AXIAL 30°

Macchina Machine	Cod. DX / RH	Cod. SX / LH	ø D mm	B mm	ø d mm	DKN	See drawings pag. 106				AS1 S1	Type	Z	Z Tot	rpm max
							A	A1	T	C					
HOMAG	D401 138	D401 338	150	43	30	2 DKN	1,5		40	1,5	AS1	2	3 + 3	18	15000
HOMAG	D401 139	D401 339	150	43	30	2 DKN	1,5		40	1,5	AS1	2	4 + 4	24	15000
HOMAG	D401 140	D401 340	150	65	30	2 DKN	13,75		40	13,75	AS1	2	3 + 3	24	15000
HOMAG	D401 141	D401 341	150	65	30	2 DKN	13,75		40	13,75	AS1	2	4 + 4	32	15000



**S1**  
DISPOSIZIONE SIMMETRICA  
SYMMETRIC TIP ARRANGEMENT

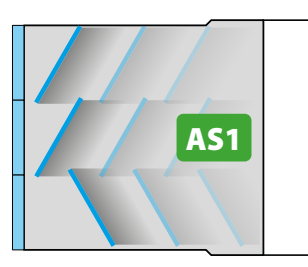

**AS1**  
DISPOSIZIONE ASIMMETRICA  
ASYMMETRIC TIP ARRANGEMENT

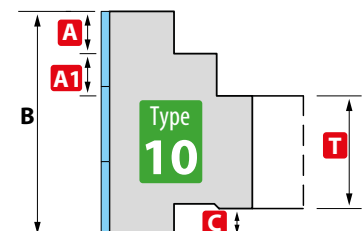
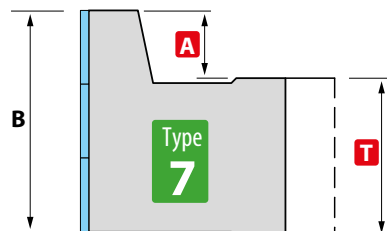
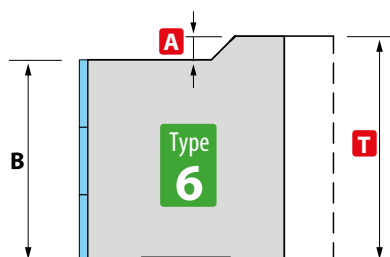
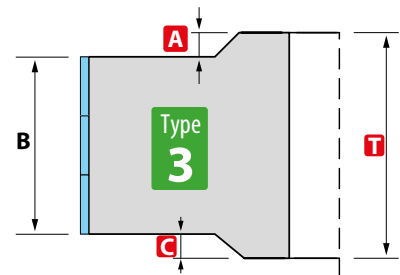
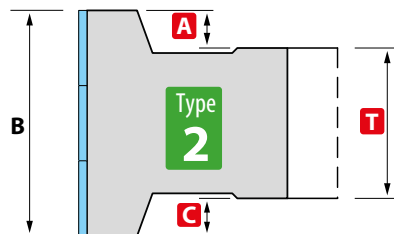
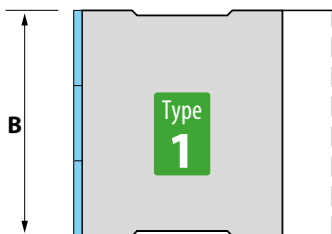

Section INDEX

Anti-splinter DP diamond cutter for edgebander, H4.5mm, 20°/30° axial angles

Diamant-Fügefräser für Kantenanleimmaschine PKD H 4,5 mm, Achswinkel 20°/30°

Fresa de diamante antiastillante con plaquita en DP de H 4,5 mm y ángulos axiales de 20°/30° para canteadora

Fraise en diamant anti éclat pour plaqueuse de chant, DP H4,5 mm avec angle axial 20°/30°

Алмазная фреза (анти-сколов) для кромкооблицовочного станка DP H4.5mm, осевые углы 20°/30°

INDEX by article



PRICE LIST

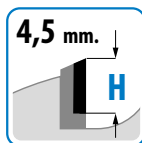
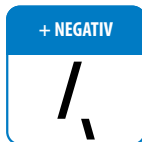

Costruite con corpo in acciaio speciali in Z=2+2/3+3 DP H4.5mm, assialità 20°/30°, disegno asimmetrico e simmetrico, per ottenere un'ottima qualità di lavorazione, finitura e scarico del truciolo

Manufactured with body of special steel in Z=2+2/3+3, DP, H4.5mm, 20°/30° axial angles, asymmetrical and symmetrical pattern, to give optimum quality of machining, finishing and chip removal

Hergestellt mit Körper aus Sonderstahl Z=2+2/3+3 PKD H 4,5 mm, Achswinkel 20°/30°, asymmetrisches und symmetrisches Design, für eine hervorragende Bearbeitungsqualität, Oberflächengüte und Spanabfuhr

Conta con cuerpo de acero especial Z=2+2/3+3 con plaquita en DP de H 4,5 mm, ángulos axiales de 20°/30°, diseño asimétrico y simétrico, para obtener una excelente calidad de mecanizado, acabado y descarga de la viruta.

Construite avec corps en acier spécial en Z2+2/3+3, DP H4,5 mm, axialité 20/30°, dessin symétrique et asymétrique pour obtenir une qualité d'usinage optimale, finition et écoulement du copeau.

Корпус из специальной стали Z=2+2/3+3 DP H4.5mm, угол 20°/30°, ассимметричный и симметричный дизайн позволяет получить отличное качество обработки, отделки и удаления стружки

### DIAMETER 60 ANGLE AXIAL 20°

Macchina Machine	Cod. DX / RH	Cod. SX / LH	ø D mm	B mm	ø d mm	DKN	See drawings pag. 110				AS1 S1	Type	Z	Z Tot	rpm max
							A	A1	T	C					
CEHISA	D403 10	D403 210	60	36	20	2 DKN	6,5		43,5		AS1	6	2+2	8	18000
CEHISA	D403 11	D403 211	60	36	20	2 DKN	6,5		43,5		AS1	6	3+3	12	18000
FRAVOL	D403 12	D403 212	60	48	25	2 DKN					AS1	1	2+2	12	18000
FRAVOL	D403 13	D403 213	60	48	25	2 DKN					AS1	1	3+3	18	18000
FELDER	D403 14	D403 214	60	48	25	2 DKN	14				AS1	6	2+2	12	18000
FELDER	D403 15	D403 215	60	48	25	2 DKN	14				AS1	6	3+3	18	18000
	D403 16	D403 216	60	48	20	2 DKN	7				AS1	7	2+2	12	18000
	D403 17	D403 217	60	48	20	2 DKN	7				AS1	7	3+3	18	18000
	D403 18	D403 218	60	55	20	2 DKN					AS1	1	2+2	14	18000
	D403 19	D403 219	60	55	20	2 DKN					AS1	1	3+3	21	18000
	D403 20	D403 220	60	55	25	2 DKN					AS1	1	2+2	14	18000
	D403 21	D403 221	60	55	25	2 DKN					AS1	1	3+3	21	18000
	D403 22	D403 222	60	55	16	2 DKN	12		31		S1	2	2+2	14	18000
	D403 23	D403 223	60	55	16	2 DKN	12		31	12	S1	2	3+3	21	18000
CEHISA	D403 24	D403 224	60	55	20	2 DKN	13		43,5	12	AS1	7	2+2	14	18000
CEHISA	D403 25	D403 225	60	55	20	2 DKN	13		43,5		AS1	7	3+3	21	18000
	D403 26	D403 226	60	55	20	2 DKN					AS1	1	2+2	16	18000
	D403 27	D403 227	60	65	20	2 DKN					AS1	1	3+3	24	18000
FELDER format 4 - FRAVOL	D403 28	D403 228	60	65	25	2 DKN					AS1	1	2+2	16	18000
FELDER format 4 - FRAVOL	D403 29	D403 229	60	65	25	2 DKN					AS1	1	3+3	24	18000
	D403 30	D403 230	60	65	25	2 DKN	8				AS1	7	2+2	16	18000
	D403 31	D403 231	60	65	25	2 DKN	8				AS1	7	3+3	24	18000

### DIAMETER 70 ANGLE AXIAL 20°

Macchina Machine	Cod. DX / RH	Cod. SX / LH	ø D mm	B mm	ø d mm	DKN	See drawings pag. 110				AS1 S1	Type	Z	Z Tot	rpm max
							A	A1	T	C					
	D403 32	D403 232	70	45	30	2 DKN	16				AS1	6	2+2	12	18000
	D403 33	D403 233	70	45	30	2 DKN	16				AS1	6	3+3	18	18000
HOLZ-HER	D403 34	D403 234	70	48	30	2 DKN	9	9	24	6	AS1	10	2+2	12	18000
HOLZ-HER	D403 35	D403 235	70	48	30	2 DKN	9	9	24	6	AS1	10	3+3	18	18000
HOLZ-HER - ARCUS 1801	D403 36	D403 236	70	48	30	2 DKN	9		41	6	AS1	2	2+2	12	18000
HOLZ-HER - ARCUS 1801	D403 37	D403 237	70	48	30	2 DKN	9		41	6	AS1	2	3+3	18	18000
	D403 38	D403 238	70	48	30	2 DKN	8				AS1	7	2+2	12	18000
	D403 39	D403 239	70	48	30	2 DKN	8				AS1	7	3+3	18	18000
Hebrock	D403 40	D403 240	70	48	25	2 DKN	12		61		AS1	6	2+2	12	18000
Hebrock	D403 41	D403 241	70	48	25	2 DKN	12		61		AS1	6	3+3	18	18000
	D403 42	D403 242	70	48	25	2 DKN	11		70	11	AS1	3	2+2	12	18000
	D403 43	D403 243	70	48	25	2 DKN	11		70	11	AS1	3	3+3	18	18000
HOLZ-HER aggregate 1801	D403 44	D403 244	70	55	30	2 DKN	9,5	9	30,5	6	AS1	10	2+2	14	18000
HOLZ-HER aggregate 1801	D403 45	D403 245	70	55	30	2 DKN	9,5	9	30,5	6	AS1	10	3+3	21	18000
HOLZ-HER - ARCUS 1801	D403 46	D403 246	70	65	30	2 DKN	9,5	9	40,5	6	AS1	10	2+2	16	18000
HOLZ-HER - ARCUS 1801	D403 47	D403 247	70	65	30	2 DKN	9,5	9	40,5	6	AS1	10	3+3	24	18000

## DIAMETER 80 ANGLE AXIAL 30°

Macchina Machine	Cod. DX / RH	Cod. SX / LH	ø D mm	B mm	ø d mm	DKN	See drawings pag. 110				AS1 S1	Type	Z	Z Tot	rpm max
							A	A1	T	C					
	D403 48	D403 248	80	25	30	2 DKN					AS1	1	2 + 2	6	18000
	D403 49	D403 249	80	25	30	2 DKN					AS1	1	3 + 3	9	18000
AKRON 1300 / 1400 AKRON 400 / 800 ROXYL - STREMA BIESSE - JADE 240	D403 50	D403 250	80	30	30	2 DKN	11,5		53	11,5	S1	3	2 + 2	8	18000
AKRON 1300 / 1400 AKRON 400 / 800 ROXYL - STREMA BIESSE - JADE 240	D403 51	D403 251	80	30	30	2 DKN	11,5		53	11,5	S1	3	3 + 3	12	18000
SCM	D403 52	D403 252	80	40	30	2 DKN					AS1	1	2 + 2	10	18000
SCM	D403 53	D403 253	80	40	30	2 DKN					AS1	1	3 + 3	15	18000
AKRON 1300 / 1400 AKRON 400 / 800 ROXYL - STREMA BIESSE - JADE 240	D403 54	D403 254	80	45	30	2 DKN	4		53	4	S1	3	2 + 2	12	18000
AKRON 1300 / 1400 AKRON 400 / 800 ROXYL - STREMA BIESSE - JADE 240	D403 55	D403 255	80	45	30	2 DKN	4		53	4	S1	3	3 + 3	18	18000
	D403 56	D403 256	80	48	30	2 DKN					AS1	1	2 + 2	12	18000
	D403 57	D403 257	80	48	30	2 DKN					AS1	1	3 + 3	18	18000
FELDER	D403 58	D403 258	80	48	30	2 DKN	15		63		AS1	6	2 + 2	12	18000
FELDER	D403 59	D403 259	80	48	30	2 DKN	15		63		AS1	6	3 + 3	18	18000
BIESSE AK - RON 246	D403 60	D403 260	80	48	20	2 DKN	11,5		25	11,5	S	2	2 + 2	12	18000
BIESSE AK - RON 246	D403 61	D403 261	80	48	20	2 DKN	11,5		25	11,5	S	2	3 + 3	18	18000
SCM ME-35 - MINIMAX	D403 62	D403 262	80	55	30	2 DKN					AS1	1	2 + 2	14	18000
SCM ME-35 - MINIMAX	D403 63	D403 263	80	55	30	2 DKN					AS1	1	3 + 3	21	18000
BIESSE AK RON 246 GRIGGIO	D403 64	D403 264	80	55	20	2 DKN	17		25	13	AS1	2	2 + 2	14	18000
BIESSE AK RON 246 GRIGGIO	D403 65	D403 265	80	55	20	2 DKN	17		25	13	AS1	2	3 + 3	21	18000
	D403 66	D403 266	80	65	25	2 DKN					AS1	1	2 + 2	16	18000
	D403 67	D403 267	80	65	25	2 DKN					AS1	1	3 + 3	24	18000
AKRON 1300 / 1400 AKRON 400 / 800 ROXYL - STREMA BIESSE - JADE 240	D403 68	D403 268	80	65	30	2 DKN	6		53	6	S1	2	2 + 2	16	18000
AKRON 1300 / 1400 AKRON 400 / 800 ROXYL - STREMA BIESSE - JADE 240	D403 69	D403 269	80	65	30	2 DKN	6		53	6	S1	2	3 + 3	24	18000
	D403 70	D403 270	80	65	30	2 DKN	10		56		AS1	7	2 + 2	16	18000
	D403 71	D403 271	80	65	30	2 DKN	10		56		AS1	7	3 + 3	24	18000
GRIGGIO	D403 72	D403 272	80	65	30	2 DKN	28		25	12	AS1	2	2 + 2	16	18000
GRIGGIO	D403 73	D403 273	80	65	30	2 DKN	28		25	12	AS1	2	3 + 3	24	18000
CEHISA	D403 74	D403 274	80	65	20	2 DKN	21,5		37	6,5	AS1	2	2 + 2	16	18000
CEHISA	D403 75	D403 275	80	65	20	2 DKN	21,5		37	6,5	AS1	2	3 + 3	24	18000

## DIAMETER 85 ANGLE AXIAL 30°

Macchina Machine	Cod. DX / RH	Cod. SX / LH	ø D mm	B mm	ø d mm	DKN	See drawings pag. 110				AS1 S1	Type	Z	Z Tot	rpm max
							A	A1	T	C					
OTT	D403 76	D403 276	85	45	30	2 DKN					AS1	1	3 + 3	24	18000
OTT	D403 77	D403 277	85	65	30	2 DKN	15				AS1	7	3 + 3	24	18000

## DIAMETER 100 ANGLE AXIAL 30°

Macchina Machine	Cod. DX / RH	Cod. SX / LH	ø D mm	B mm	ø d mm	DKN	See drawings pag. 110				AS1 S1	Type	Z	Z Tot	rpm max
							A	A1	T	C					
IMA - BRANDT	D403 78	D403 278	100	35	30	2 DKN					S1	1	2 + 2	8	18000
IMA - BRANDT	D403 79	D403 279	100	35	30	2 DKN					S1	1	3 + 3	12	18000
	D403 80	D403 280	100	45	30	2 DKN					AS1	1	2 + 2	12	18000
	D403 81	D403 281	100	45	30	2 DKN					AS1	1	3 + 3	18	18000
	D403 82	D403 282	100	45	30	2 DKN					S1	1	2 + 2	12	18000
	D403 83	D403 283	100	45	30	2 DKN					S1	1	3 + 3	18	18000
BRANDT	D403 84	D403 284	100	45	30	2 DKN	5,4		40,6		AS1	7	2 + 2	12	18000
BRANDT	D403 85	D403 285	100	45	30	2 DKN	5,4		40,6		AS1	7	3 + 3	18	18000
HEBROCK - EBM - BRANDT AMBITION - 1110 F	D403 86	D403 286	100	45	30	2 DKN	16		61		AS1	6	2 + 2	12	18000
HEBROCK - EBM - BRANDT AMBITION - 1110 F	D403 87	D403 287	100	45	30	2 DKN	16		61		AS1	6	3 + 3	18	18000
	D403 88	D403 288	100	45	30	2 DKN	12		75	15	AS1	3	2 + 2	12	18000
	D403 89	D403 289	100	45	30	2 DKN	12		75	15	AS1	3	3 + 3	18	18000
	D403 90	D403 290	100	48	25	2 DKN					AS1	1	2 + 2	12	18000
	D403 91	D403 291	100	48	25	2 DKN					AS1	1	3 + 3	18	18000
HOLZ-HER - UPTO 2008 . SCM	D403 92	D403 292	100	48	30	2 DKN	11,5		25	11,5	AS1	2	2 + 2	12	18000
HOLZ-HER - UPTO 2008 . SCM	D403 93	D403 293	100	48	30	2 DKN	11,5		25	11,5	AS1	2	3 + 3	18	18000
BRANDT - IMA - SCM K360 - K560 - IDM - BIESSE	D403 94	D403 294	100	48	30	2 DKN	7,4		40,6		AS1	7	2 + 2	12	18000
BRANDT - IMA - SCM K360 - K560 - IDM - BIESSE	D403 95	D403 295	100	48	30	2 DKN	7,4		40,6		AS1	7	3 + 3	18	18000
BRANDT - IMA - SCM K360 - K560 - IDM - BIESSE	D403 96	D403 296	100	48	30	2 DKN	4		40	4	AS1	2	2 + 2	12	18000
BRANDT - IMA - SCM K360 - K560 - IDM - BIESSE	D403 97	D403 297	100	48	30	2 DKN	4		40	4	AS1	2	3 + 3	18	18000
	D403 98	D403 298	100	55	30	2 DKN					AS1	1	2 + 2	14	18000
	D403 99	D403 299	100	55	30	2 DKN					AS1	1	3 + 3	21	18000
HOLZ-HER UP TO 2008 - SCM	D403 100	D403 300	100	55	30	2 DKN	18,5		25	11,5	AS1	2	2 + 2	14	18000
HOLZ-HER UP TO 2008 - SCM	D403 101	D403 301	100	55	30	2 DKN	18,5		25	11,5	AS1	2	3 + 3	21	18000
BRANDT - IMA - SCM K360 - K560 - IDM - BIESSE	D403 102	D403 302	100	55	30	2 DKN	14,4		40,6		AS1	7	2 + 2	14	18000
BRANDT - IMA - SCM K360 - K560 - IDM - BIESSE	D403 103	D403 303	100	55	30	2 DKN	14,4		40,6		AS1	7	3 + 3	21	18000
	D403 104	D403 304	100	65	30	2 DKN					AS1	1	2 + 2	16	18000
	D403 105	D403 305	100	65	30	2 DKN					AS1	1	3 + 3	24	18000
BIESSE AKRON 600 - AKRON 800	D403 106	D403 306	100	65	30	2 DKN	5		75	5	S1	3	2 + 2	16	18000
BIESSE AKRON 600 - AKRON 800	D403 107	D403 307	100	65	30	2 DKN	5		75	5	S1	3	3 + 3	24	18000
BRANDT - IMA - SCM K360 - K560 - IDM - BIESSE	D403 108	D403 308	100	65	30	2 DKN	25,4		40,6		AS1	7	2 + 2	16	18000
BRANDT - IMA - SCM K360 - K560 - IDM - BIESSE	D403 109	D403 309	100	65	30	2 DKN	25,4		40,6		AS1	7	3 + 3	24	18000
HOLZ-HER UP TO 2008 - SCM	D403 110	D403 310	100	65	30	2 DKN	12		26	27	AS1	2	2 + 2	16	18000
HOLZ-HER UP TO 2008 - SCM	D403 111	D403 311	100	65	30	2 DKN	12		26	27	AS1	2	3 + 3	24	18000
CEHISA	D403 112	D403 312	100	65	20	2 DKN	21,5		37	6,5	AS1	2	2 + 2	16	18000
CEHISA	D403 113	D403 313	100	65	20	2 DKN	21,5		37	6,5	AS1	2	3 + 3	24	18000
HOLZ-HER	D403 114	D403 314	100	65	30	2 DKN	16		40	9	AS1	2	2 + 2	16	18000
HOLZ-HER	D403 115	D403 315	100	65	30	2 DKN	16		40	9	AS1	2	3 + 3	24	18000



## DIAMETER 125 ANGLE AXIAL 30°

Macchina Machine	Cod. DX / RH	Cod. SX / LH	ø D mm	B mm	ø d mm	DKN	See drawings pag. 110				AS1 S1	Type	Z	Z Tot	rpm max
							A	A1	T	C					
IMA - HOMAG	D403 116	D403 316	125	34	30	2 DKN					AS1	1	3 + 3	12	15000
IMA - HOMAG	D403 117	D403 317	125	34	30	2 DKN					AS1	1	4 + 4	16	15000
	D403 118	D403 318	125	43	30	2 DKN	14		57		AS1	6	3 + 3	18	15000
	D403 119	D403 319	125	43	30	2 DKN	14		57		AS1	6	4 + 4	24	15000
IMA - BIESSE	D403 120	D403 320	125	45	30	2 DKN					AS1	1	3 + 3	18	15000
IMA - BIESSE	D403 121	D403 321	125	45	30	2 DKN					AS1	1	4 + 4	24	15000
HOMAG - BIESSE	D403 122	D403 322	125	45	30	2 DKN	6				AS1	7	3 + 3	18	15000
HOMAG - BIESSE	D403 123	D403 323	125	45	30	2 DKN	6				AS1	7	4 + 4	24	15000
BIESSE	D403 124	D403 324	125	48	30	2 DKN					AS1	1	3 + 3	18	15000
BIESSE	D403 125	D403 325	125	48	30	2 DKN					AS1	1	4 + 4	24	15000
HOMAG	D403 126	D403 326	125	48	30	2 DKN	4		40	4	AS1	2	3 + 3	18	15000
HOMAG	D403 127	D403 327	125	48	30	2 DKN	4		40	4	AS1	2	4 + 4	24	15000
	D403 128	D403 328	125	65	30	2 DKN					AS1	1	3 + 3	24	15000
	D403 129	D403 329	125	65	30	2 DKN					AS1	1	4 + 4	32	15000
BIESSE	D403 130	D403 330	125	65	30	2 DKN	8		49	8	AS1	2	3 + 3	24	15000
BIESSE	D403 131	D403 331	125	65	30	2 DKN	8		49	8	AS1	2	4 + 4	32	15000
BRANDT - IMA - SCM IDM - BIESSE	D403 132	D403 332	125	65	30	2 DKN	25,4		40,6		AS1	7	3 + 3	24	15000
BRANDT - IMA - SCM IDM - BIESSE	D403 133	D403 333	125	65	30	2 DKN	25,4		40,6		AS1	7	4 + 4	32	15000
HOMAG	D403 134	D403 334	125	65	30	2 DKN	12,5		40	12,5	AS1	2	3 + 3	24	15000
HOMAG	D403 135	D403 335	125	65	30	2 DKN	12,5		40	12,5	AS1	2	4 + 4	32	15000
GRIGGIO - HOLZ-HER	D403 136	D403 336	125	65	30	2 DKN	28		25	12	AS1	2	3 + 3	24	15000
GRIGGIO - HOLZ-HER	D403 137	D403 337	125	65	30	2 DKN	28		25	12	AS1	2	4 + 4	32	15000

## DIAMETER 150 ANGLE AXIAL 30°

Macchina Machine	Cod. DX / RH	Cod. SX / LH	ø D mm	B mm	ø d mm	DKN	See drawings pag. 110				AS1 S1	Type	Z	Z Tot	rpm max
							A	A1	T	C					
HOMAG	D403 138	D403 338	150	43	30	2 DKN	1,5		40	1,5	AS1	2	3 + 3	18	15000
HOMAG	D403 139	D403 339	150	43	30	2 DKN	1,5		40	1,5	AS1	2	4 + 4	24	15000
HOMAG	D403 140	D403 340	150	65	30	2 DKN	13,75		40	13,75	AS1	2	3 + 3	24	15000
HOMAG	D403 141	D403 341	150	65	30	2 DKN	13,75		40	13,75	AS1	2	4 + 4	32	15000



**S1**  
DISPOSIZIONE SIMMETRICA  
SYMMETRIC TIP ARRANGEMENT

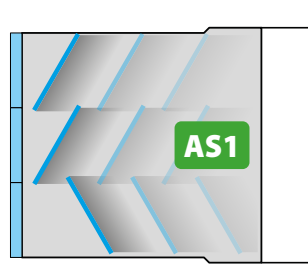

**AS1**  
DISPOSIZIONE ASIMMETRICA  
ASYMMETRIC TIP ARRANGEMENT

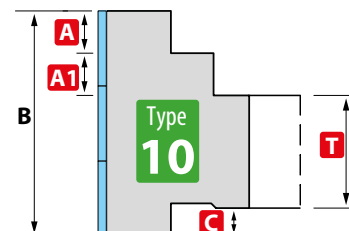
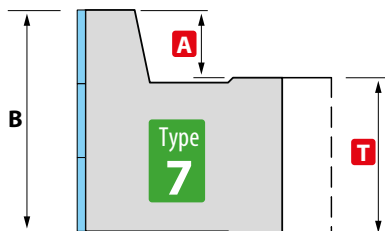
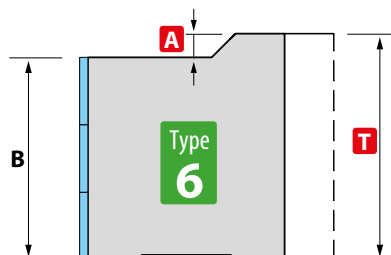
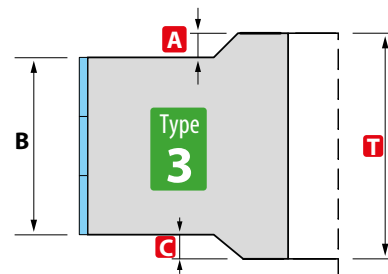
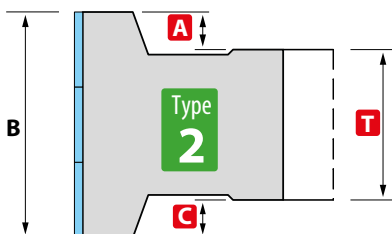
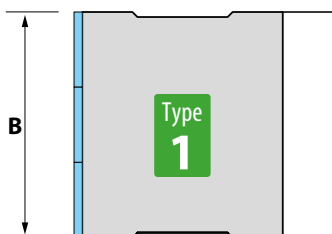

# Art. D402

## Fresa in diamante antischeggia per bordatrice DP H2.5mm, angoli assiali 20°/30°

Section INDEX

Anti-splinter DP diamond cutter for edgebander, H2.5mm, 20°/30° axial angles

Diamant-Fügefräser für Kantenanleimmaschine PKD H 2,5 mm, Achswinkel 20°/30°, Geräuschreduzierung durch Schlitze

Fresa de diamante antiastillante con plaquita en DP de H 2,5 mm, ángulos axiales de 20°/30° y ojales antiruido

Fraise en diamant anti éclats pour plaqueuses de chant, DP H 2,5 mm, angle axial 20°/30°

Алмазная фреза (анти-сколов) для кромкооблицовочного станка DP H2.5mm, осевые углы 20°/30°

INDEX by article

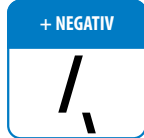

PRICE LIST

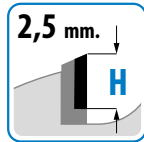

Costruite con corpo in acciaio speciali in Z=2+2/3+3 DP H2.5mm, assialità 20°/30°, disegno asimmetrico e simmetrico, con asole antirumore (silenziate), per ottenere un'ottima qualità di lavorazione, finitura e scarico del truciolo

Manufactured with body of special steel, Z=2+2/3+3, DP, H2.5mm, 20°/30° axial angles, asymmetrical and symmetrical pattern, with sound attenuating slots (low noise), to give optimum quality of machining, finishing and chip removal

Hergestellt mit Körper aus Sonderstahl in Z=2+2/3+3 PKD H 2,5 mm, Achswinkel 20°/30°, asymmetrisches und symmetrisches Design, Geräuschreduzierung durch Schlitze, für eine hervorragende Bearbeitungsqualität, Oberflächengüte und Spanabfuhr

Cuenta con cuerpo de acero especial Z=2+2/3+3 con plaquita en DP de H 2,5 mm, ángulos axiales de 20°/30°, diseño asimétrico y simétrico, ojales antiruido (silenciados) para obtener una excelente calidad de mecanizado, acabado y descarga de la viruta.

Costruite avec corps en acier spécial en Z2+2/3+3 DP H 2,5 mm, axialité 20°/30°, dessin symétrique et asymétrique, avec fentes anti bruit (silencieuse) pour obtenir une qualité d'usinage optimale, finition et écoulement du copeau.

Корпус из специальной стали Z=2+2/3+3 DP H2.5mm, угол 20°/30°, асимметричный и симметричный дизайн с прорезями (с глушителем) позволяет получить отличное качество обработки, отделки и удаления стружки

### DIAMETER 60 ANGLE AXIAL 20°

Macchina Machine	Cod. DX / RH	Cod. SX / LH	ø D mm	B mm	ø d mm	DKN	See drawings pag. 114				AS1 S1	Type	Z	Z Tot	rpm max
							A	A1	T	C					
CEHISA	D402 10	D402 210	60	36	20	2 DKN	6,5		43,5		AS1	6	2 + 2	8	18000
CEHISA	D402 11	D402 211	60	36	20	2 DKN	6,5		43,5		AS1	6	3 + 3	12	18000
FRAVOL	D402 12	D402 212	60	48	25	2 DKN					AS1	1	2 + 2	12	18000
FRAVOL	D402 13	D402 213	60	48	25	2 DKN					AS1	1	3 + 3	18	18000
FELDER	D402 14	D402 214	60	48	25	2 DKN	14				AS1	6	2 + 2	12	18000
FELDER	D402 15	D402 215	60	48	25	2 DKN	14				AS1	6	3 + 3	18	18000
	D402 16	D402 216	60	48	20	2 DKN	7				AS1	7	2 + 2	12	18000
	D402 17	D402 217	60	48	20	2 DKN	7				AS1	7	3 + 3	18	18000
	D402 18	D402 218	60	55	20	2 DKN					AS1	1	2 + 2	14	18000
	D402 19	D402 219	60	55	20	2 DKN					AS1	1	3 + 3	21	18000
	D402 20	D402 220	60	55	25	2 DKN					AS1	1	2 + 2	14	18000
	D402 21	D402 221	60	55	25	2 DKN					AS1	1	3 + 3	21	18000
	D402 22	D402 222	60	55	16	2 DKN	12		31		S1	2	2 + 2	14	18000
	D402 23	D402 223	60	55	16	2 DKN	12		31	12	S1	2	3 + 3	21	18000
CEHISA	D402 24	D402 224	60	55	20	2 DKN	13		43,5	12	AS1	7	2 + 2	14	18000
CEHISA	D402 25	D402 225	60	55	20	2 DKN	13		43,5		AS1	7	3 + 3	21	18000
	D402 26	D402 226	60	55	20	2 DKN					AS1	1	2 + 2	16	18000
	D402 27	D402 227	60	65	20	2 DKN					AS1	1	3 + 3	24	18000
FELDER format 4 - FRAVOL	D402 28	D402 228	60	65	25	2 DKN					AS1	1	2 + 2	16	18000
FELDER format 4 - FRAVOL	D402 29	D402 229	60	65	25	2 DKN					AS1	1	3 + 3	24	18000
	D402 30	D402 230	60	65	25	2 DKN	8				AS1	7	2 + 2	16	18000
	D402 31	D402 231	60	65	25	2 DKN	8				AS1	7	3 + 3	24	18000

### DIAMETER 70 ANGLE AXIAL 20°

Macchina Machine	Cod. DX / RH	Cod. SX / LH	ø D mm	B mm	ø d mm	DKN	See drawings pag. 114				AS1 S1	Type	Z	Z Tot	rpm max
							A	A1	T	C					
	D402 32	D402 232	70	45	30	2 DKN	16				AS1	6	2 + 2	12	18000
	D402 33	D402 233	70	45	30	2 DKN	16				AS1	6	3 + 3	18	18000
HOLZ-HER	D402 34	D402 234	70	48	30	2 DKN	9	9	24	6	AS1	10	2 + 2	12	18000
HOLZ-HER	D402 35	D402 235	70	48	30	2 DKN	9	9	24	6	AS1	10	3 + 3	18	18000
HOLZ-HER - ARCUS 1801	D402 36	D402 236	70	48	30	2 DKN	9		41	6	AS1	2	2 + 2	12	18000
HOLZ-HER - ARCUS 1801	D402 37	D402 237	70	48	30	2 DKN	9		41	6	AS1	2	3 + 3	18	18000
	D402 38	D402 238	70	48	30	2 DKN	8				AS1	7	2 + 2	12	18000
	D402 39	D402 239	70	48	30	2 DKN	8				AS1	7	3 + 3	18	18000
Hebrock	D402 40	D402 240	70	48	25	2 DKN	12		61		AS1	6	2 + 2	12	18000
Hebrock	D402 41	D402 241	70	48	25	2 DKN	12		61		AS1	6	3 + 3	18	18000
	D402 42	D402 242	70	48	25	2 DKN	11		70	11	AS1	3	2 + 2	12	18000
	D402 43	D402 243	70	48	25	2 DKN	11		70	11	AS1	3	3 + 3	18	18000
HOLZ-HER aggregate 1801	D402 44	D402 244	70	55	30	2 DKN	9,5	9	30,5	6	AS1	10	2 + 2	14	18000
HOLZ-HER aggregate 1801	D402 45	D402 245	70	55	30	2 DKN	9,5	9	30,5	6	AS1	10	3 + 3	21	18000
HOLZ-HER - ARCUS 1801	D402 46	D402 246	70	65	30	2 DKN	9,5	9	40,5	6	AS1	10	2 + 2	16	18000
HOLZ-HER - ARCUS 1801	D402 47	D402 247	70	65	30	2 DKN	9,5	9	40,5	6	AS1	10	3 + 3	24	18000



<b>DIAMETER 80</b>								<b>ANGLE AXIAL 30°</b>							
Macchina Machine	Cod. DX / RH	Cod. SX / LH	ø D mm	B mm	ø d mm	DKN	See drawings pag. 114				AS1 S1	Type	Z	Z Tot	rpm max
							A	A1	T	C					
	D402 48	D402 248	80	25	30	2 DKN					AS1	1	2 + 2	6	18000
	D402 49	D402 249	80	25	30	2 DKN					AS1	1	3 + 3	9	18000
AKRON 1300 / 1400 AKRON 400 / 800 ROXYL - STREMA BIESSE - JADE 240	D402 50	D402 250	80	30	30	2 DKN	11,5		53	11,5	S1	3	2 + 2	8	18000
AKRON 1300 / 1400 AKRON 400 / 800 ROXYL - STREMA BIESSE - JADE 240	D402 51	D402 251	80	30	30	2 DKN	11,5		53	11,5	S1	3	3 + 3	12	18000
SCM	D402 52	D402 252	80	40	30	2 DKN					AS1	1	2 + 2	10	18000
SCM	D402 53	D402 253	80	40	30	2 DKN					AS1	1	3 + 3	15	18000
AKRON 1300 / 1400 AKRON 400 / 800 ROXYL - STREMA BIESSE - JADE 240	D402 54	D402 254	80	45	30	2 DKN	4		53	4	S1	3	2 + 2	12	18000
AKRON 1300 / 1400 AKRON 400 / 800 ROXYL - STREMA BIESSE - JADE 240	D402 55	D402 255	80	45	30	2 DKN	4		53	4	S1	3	3 + 3	18	18000
	D402 56	D402 256	80	48	30	2 DKN					AS1	1	2 + 2	12	18000
	D402 57	D402 257	80	48	30	2 DKN					AS1	1	3 + 3	18	18000
FELDER	D402 58	D402 258	80	48	30	2 DKN	15		63		AS1	6	2 + 2	12	18000
FELDER	D402 59	D402 259	80	48	30	2 DKN	15		63		AS1	6	3 + 3	18	18000
BIESSE AK - RON 246	D402 60	D402 260	80	48	20	2 DKN	11,5		25	11,5	S	2	2 + 2	12	18000
BIESSE AK - RON 246	D402 61	D402 261	80	48	20	2 DKN	11,5		25	11,5	S	2	3 + 3	18	18000
SCM ME-35 - MINIMAX	D402 62	D402 262	80	55	30	2 DKN					AS1	1	2 + 2	14	18000
SCM ME-35 - MINIMAX	D402 63	D402 263	80	55	30	2 DKN					AS1	1	3 + 3	21	18000
BIESSE AK RON 246 GRIGGIO	D402 64	D402 264	80	55	20	2 DKN	17		25	13	AS1	2	2 + 2	14	18000
BIESSE AK RON 246 GRIGGIO	D402 65	D402 265	80	55	20	2 DKN	17		25	13	AS1	2	3 + 3	21	18000
	D402 66	D402 266	80	65	25	2 DKN					AS1	1	2 + 2	16	18000
	D402 67	D402 267	80	65	25	2 DKN					AS1	1	3 + 3	24	18000
AKRON 1300 / 1400 AKRON 400 / 800 ROXYL - STREMA BIESSE - JADE 240	D402 68	D402 268	80	65	30	2 DKN	6		53	6	S1	2	2 + 2	16	18000
AKRON 1300 / 1400 AKRON 400 / 800 ROXYL - STREMA BIESSE - JADE 240	D402 69	D402 269	80	65	30	2 DKN	6		53	6	S1	2	3 + 3	24	18000
	D402 70	D402 270	80	65	30	2 DKN	10		56		AS1	7	2 + 2	16	18000
	D402 71	D402 271	80	65	30	2 DKN	10		56		AS1	7	3 + 3	24	18000
GRIGGIO	D402 72	D402 272	80	65	30	2 DKN	28		25	12	AS1	2	2 + 2	16	18000
GRIGGIO	D402 73	D402 273	80	65	30	2 DKN	28		25	12	AS1	2	3 + 3	24	18000
CEHISA	D402 74	D402 274	80	65	20	2 DKN	21,5		37	6,5	AS1	2	2 + 2	16	18000
CEHISA	D402 75	D402 275	80	65	20	2 DKN	21,5		37	6,5	AS1	2	3 + 3	24	18000

<b>DIAMETER 85</b>								<b>ANGLE AXIAL 30°</b>							
Macchina Machine	Cod. DX / RH	Cod. SX / LH	ø D mm	B mm	ø d mm	DKN	See drawings pag. 114				AS1 S1	Type	Z	Z Tot	rpm max
							A	A1	T	C					
OTT	D402 76	D402 276	85	45	30	2 DKN					AS1	1	3 + 3	24	18000
OTT	D402 77	D402 277	85	65	30	2 DKN	15				AS1	7	3 + 3	24	18000



## DIAMETER 100 ANGLE AXIAL 30°

Macchina Machine	Cod. DX / RH	Cod. SX / LH	ø D mm	B mm	ø d mm	DKN	See drawings pag. 114				AS1 S1	Type	Z	Z Tot	rpm max
							A	A1	T	C					
IMA - BRANDT	D402 78	D402 278	100	35	30	2 DKN					S1	1	2 + 2	8	18000
IMA - BRANDT	D402 79	D402 279	100	35	30	2 DKN					S1	1	3 + 3	12	18000
	D402 80	D402 280	100	45	30	2 DKN					AS1	1	2 + 2	12	18000
	D402 81	D402 281	100	45	30	2 DKN					AS1	1	3 + 3	18	18000
	D402 82	D402 282	100	45	30	2 DKN					S1	1	2 + 2	12	18000
	D402 83	D402 283	100	45	30	2 DKN					S1	1	3 + 3	18	18000
BRANDT	D402 84	D402 284	100	45	30	2 DKN	5,4		40,6		AS1	7	2 + 2	12	18000
BRANDT	D402 85	D402 285	100	45	30	2 DKN	5,4		40,6		AS1	7	3 + 3	18	18000
HEBROCK - EBM - BRANDT AMBITION - 1110 F	D402 86	D402 286	100	45	30	2 DKN	16		61		AS1	6	2 + 2	12	18000
HEBROCK - EBM - BRANDT AMBITION - 1110 F	D402 87	D402 287	100	45	30	2 DKN	16		61		AS1	6	3 + 3	18	18000
	D402 88	D402 288	100	45	30	2 DKN	12		75	15	AS1	3	2 + 2	12	18000
	D402 89	D402 289	100	45	30	2 DKN	12		75	15	AS1	3	3 + 3	18	18000
	D402 90	D402 290	100	48	25	2 DKN					AS1	1	2 + 2	12	18000
	D402 91	D402 291	100	48	25	2 DKN					AS1	1	3 + 3	18	18000
HOLZ-HER - UPTO 2008 . SCM	D402 92	D402 292	100	48	30	2 DKN	11,5		25	11,5	AS1	2	2 + 2	12	18000
HOLZ-HER - UPTO 2008 . SCM	D402 93	D402 293	100	48	30	2 DKN	11,5		25	11,5	AS1	2	3 + 3	18	18000
BRANDT - IMA - SCM K360 - K560 - IDM - BIESSE	D402 94	D402 294	100	48	30	2 DKN	7,4		40,6		AS1	7	2 + 2	12	18000
BRANDT - IMA - SCM K360 - K560 - IDM - BIESSE	D402 95	D402 295	100	48	30	2 DKN	7,4		40,6		AS1	7	3 + 3	18	18000
BRANDT - IMA - SCM K360 - K560 - IDM - BIESSE	D402 96	D402 296	100	48	30	2 DKN	4		40	4	AS1	2	2 + 2	12	18000
BRANDT - IMA - SCM K360 - K560 - IDM - BIESSE	D402 97	D402 297	100	48	30	2 DKN	4		40	4	AS1	2	3 + 3	18	18000
	D402 98	D402 298	100	55	30	2 DKN					AS1	1	2 + 2	14	18000
	D402 99	D402 299	100	55	30	2 DKN					AS1	1	3 + 3	21	18000
HOLZ-HER UP TO 2008 - SCM	D402 100	D402 300	100	55	30	2 DKN	18,5		25	11,5	AS1	2	2 + 2	14	18000
HOLZ-HER UP TO 2008 - SCM	D402 101	D402 301	100	55	30	2 DKN	18,5		25	11,5	AS1	2	3 + 3	21	18000
BRANDT - IMA - SCM K360 - K560 - IDM - BIESSE	D402 102	D402 302	100	55	30	2 DKN	14,4		40,6		AS1	7	2 + 2	14	18000
BRANDT - IMA - SCM K360 - K560 - IDM - BIESSE	D402 103	D402 303	100	55	30	2 DKN	14,4		40,6		AS1	7	3 + 3	21	18000
	D402 104	D402 304	100	65	30	2 DKN					AS1	1	2 + 2	16	18000
	D402 105	D402 305	100	65	30	2 DKN					AS1	1	3 + 3	24	18000
BIESSE AKRON 600 - AKRON 800	D402 106	D402 306	100	65	30	2 DKN	5		75	5	S1	3	2 + 2	16	18000
BIESSE AKRON 600 - AKRON 800	D402 107	D402 307	100	65	30	2 DKN	5		75	5	S1	3	3 + 3	24	18000
BRANDT - IMA - SCM K360 - K560 - IDM - BIESSE	D402 108	D402 308	100	65	30	2 DKN	25,4		40,6		AS1	7	2 + 2	16	18000
BRANDT - IMA - SCM K360 - K560 - IDM - BIESSE	D402 109	D402 309	100	65	30	2 DKN	25,4		40,6		AS1	7	3 + 3	24	18000
HOLZ-HER UP TO 2008 - SCM	D402 110	D402 310	100	65	30	2 DKN	12		26	27	AS1	2	2 + 2	16	18000
HOLZ-HER UP TO 2008 - SCM	D402 111	D402 311	100	65	30	2 DKN	12		26	27	AS1	2	3 + 3	24	18000
CEHISA	D402 112	D402 312	100	65	20	2 DKN	21,5		37	6,5	AS1	2	2 + 2	16	18000
CEHISA	D402 113	D402 313	100	65	20	2 DKN	21,5		37	6,5	AS1	2	3 + 3	24	18000
HOLZ-HER	D402 114	D402 314	100	65	30	2 DKN	16		40	9	AS1	2	2 + 2	16	18000
HOLZ-HER	D402 115	D402 315	100	65	30	2 DKN	16		40	9	AS1	2	3 + 3	24	18000



## DIAMETER 125 ANGLE AXIAL 30°

Macchina Machine	Cod. DX / RH	Cod. SX / LH	ø D mm	B mm	ø d mm	DKN	See drawings pag. 114				AS1 S1	Type	Z	Z Tot	rpm max
							A	A1	T	C					
IMA - HOMAG	D402 116	D402 316	125	34	30	2 DKN					AS1	1	3 + 3	12	15000
IMA - HOMAG	D402 117	D402 317	125	34	30	2 DKN					AS1	1	4 + 4	16	15000
	D402 118	D402 318	125	43	30	2 DKN	14		57		AS1	6	3 + 3	18	15000
	D402 119	D402 319	125	43	30	2 DKN	14		57		AS1	6	4 + 4	24	15000
IMA - BIESSE	D402 120	D402 320	125	45	30	2 DKN					AS1	1	3 + 3	18	15000
IMA - BIESSE	D402 121	D402 321	125	45	30	2 DKN					AS1	1	4 + 4	24	15000
HOMAG - BIESSE	D402 122	D402 322	125	45	30	2 DKN	6				AS1	7	3 + 3	18	15000
HOMAG - BIESSE	D402 123	D402 323	125	45	30	2 DKN	6				AS1	7	4 + 4	24	15000
BIESSE	D402 124	D402 324	125	48	30	2 DKN					AS1	1	3 + 3	18	15000
BIESSE	D402 125	D402 325	125	48	30	2 DKN					AS1	1	4 + 4	24	15000
HOMAG	D402 126	D402 326	125	48	30	2 DKN	4		40	4	AS1	2	3 + 3	18	15000
HOMAG	D402 127	D402 327	125	48	30	2 DKN	4		40	4	AS1	2	4 + 4	24	15000
	D402 128	D402 328	125	65	30	2 DKN					AS1	1	3 + 3	24	15000
	D402 129	D402 329	125	65	30	2 DKN					AS1	1	4 + 4	32	15000
BIESSE	D402 130	D402 330	125	65	30	2 DKN	8		49	8	AS1	2	3 + 3	24	15000
BIESSE	D402 131	D402 331	125	65	30	2 DKN	8		49	8	AS1	2	4 + 4	32	15000
BRANDT - IMA - SCM IDM - BIESSE	D402 132	D402 332	125	65	30	2 DKN	25,4		40,6		AS1	7	3 + 3	24	15000
BRANDT - IMA - SCM IDM - BIESSE	D402 133	D402 333	125	65	30	2 DKN	25,4		40,6		AS1	7	4 + 4	32	15000
HOMAG	D402 134	D402 334	125	65	30	2 DKN	12,5		40	12,5	AS1	2	3 + 3	24	15000
HOMAG	D402 135	D402 335	125	65	30	2 DKN	12,5		40	12,5	AS1	2	4 + 4	32	15000
GRIGGIO - HOLZ-HER	D402 136	D402 336	125	65	30	2 DKN	28		25	12	AS1	2	3 + 3	24	15000
GRIGGIO - HOLZ-HER	D402 137	D402 337	125	65	30	2 DKN	28		25	12	AS1	2	4 + 4	32	15000

## DIAMETER 150 ANGLE AXIAL 30°

Macchina Machine	Cod. DX / RH	Cod. SX / LH	ø D mm	B mm	ø d mm	DKN	See drawings pag. 114				AS1 S1	Type	Z	Z Tot	rpm max
							A	A1	T	C					
HOMAG	D402 138	D402 338	150	43	30	2 DKN	1,5		40	1,5	AS1	2	3 + 3	18	15000
HOMAG	D402 139	D402 339	150	43	30	2 DKN	1,5		40	1,5	AS1	2	4 + 4	24	15000
HOMAG	D402 140	D402 340	150	65	30	2 DKN	13,75		40	13,75	AS1	2	3 + 3	24	15000
HOMAG	D402 141	D402 341	150	65	30	2 DKN	13,75		40	13,75	AS1	2	4 + 4	32	15000



**S1**  
DISPOSIZIONE SIMMETRICA  
SYMMETRIC TIP ARRANGEMENT

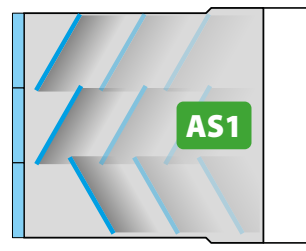

**AS1**  
DISPOSIZIONE ASIMMETRICA  
ASYMMETRIC TIP ARRANGEMENT

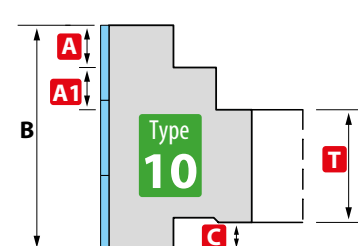
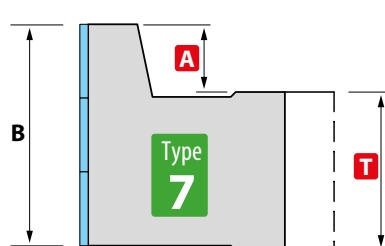
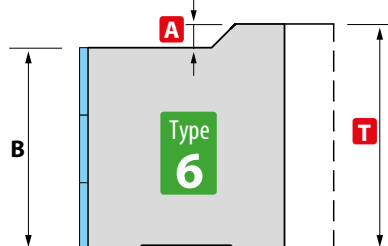
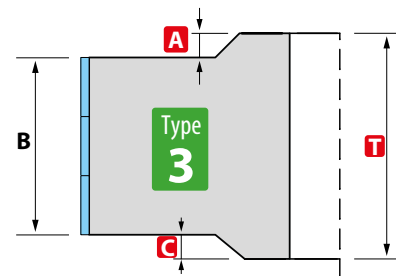
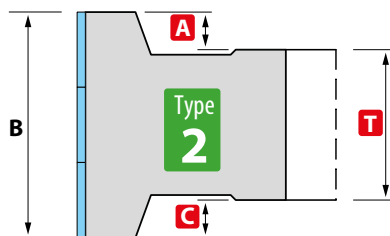
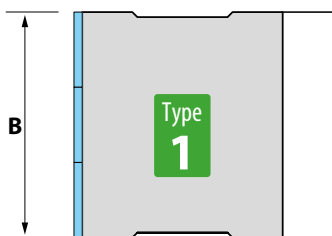

Section INDEX

Anti-splinter DP diamond cutter for edgebander, H4.5mm, 20°/30° axial angles

Diamant-Fügefräser für Kantenanleimmaschine PKD H 4,5 mm, Achswinkel 20°/30°

Fresa de diamante antiastillante con plaquita en DP de H 4,5 mm, ángulos axiales de 20°/30° y ojales antiruido

Fraise en diamant anti éclats pour plaqueuses de chant, DP H4,5 mm, angle axial 20°/30°

Алмазная фреза (анти сколов) для кромкооблицовочного станка DP H4.5mm, осевые углы 20°/30°

INDEX by article

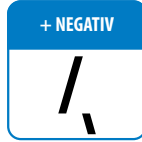

PRICE LIST

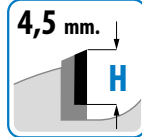

Costruite con corpo in acciaio speciale in Z=2+2/3+3 DP H4.5mm disegno asimmetrico e simmetrico, con asole antirumore (silenziate) per ottenere un'ottima qualità di lavorazione, finitura e scarico del truciolo.

Manufactured with body of special steel, Z=2+2/3+3, DP, H 4.5mm, asymmetrical and symmetrical pattern, with sound attenuating slots (low noise), to give optimum quality of machining, finishing and chip removal.

Hergestellt mit Körper aus Sonderstahl in Z=2+2/3+3 PKD H 4,5 mm, asymmetrisches und symmetrisches Design, Geräuschreduzierung durch Schlitze, für eine hervorragende Bearbeitungsqualität, Oberflächengüte und Spanabfuhr.

Cuenta con cuerpo de acero especial Z=2+2/3+3 con plaquita en DP de H 4,5 mm, diseño asimétrico y simétrico, ojales antiruido (silenciados) para obtener una excelente calidad de mecanizado, acabado y descarga de la viruta.

Construite avec corps en acier spécial en Z2+2/3+3, DP H4,5 mm, dessin symétrique et asymétrique, avec fentes anti bruit (silencieuse) pour obtenir une qualité d'usinage optimale, finition et écoulement du copeau.

Корпус из специальной стали Z=2+2/3+3 DP H4.5mm, угол 20°/30° с прорезями (с глушителем), асимметричный и симметричный дизайн позволяет получить отличное качество обработки, отделки и удаления стружки

### DIAMETER 60 ANGLE AXIAL 20°

Macchina Machine	Cod. DX / RH	Cod. SX / LH	ø D mm	B mm	ø d mm	DKN	See drawings pag. 118				AS1 S1	Type	Z	Z Tot	rpm max
							A	A1	T	C					
CEHISA	D404 10	D404 210	60	36	20	2 DKN	6,5		43,5		AS1	6	2+2	8	18000
CEHISA	D404 11	D404 211	60	36	20	2 DKN	6,5		43,5		AS1	6	3+3	12	18000
FRAVOL	D404 12	D404 212	60	48	25	2 DKN					AS1	1	2+2	12	18000
FRAVOL	D404 13	D404 213	60	48	25	2 DKN					AS1	1	3+3	18	18000
FELDER	D404 14	D404 214	60	48	25	2 DKN	14				AS1	6	2+2	12	18000
FELDER	D404 15	D404 215	60	48	25	2 DKN	14				AS1	6	3+3	18	18000
	D404 16	D404 216	60	48	20	2 DKN	7				AS1	7	2+2	12	18000
	D404 17	D404 217	60	48	20	2 DKN	7				AS1	7	3+3	18	18000
	D404 18	D404 218	60	55	20	2 DKN					AS1	1	2+2	14	18000
	D404 19	D404 219	60	55	20	2 DKN					AS1	1	3+3	21	18000
	D404 20	D404 220	60	55	25	2 DKN					AS1	1	2+2	14	18000
	D404 21	D404 221	60	55	25	2 DKN					AS1	1	3+3	21	18000
	D404 22	D404 222	60	55	16	2 DKN	12		31		S1	2	2+2	14	18000
	D404 23	D404 223	60	55	16	2 DKN	12		31	12	S1	2	3+3	21	18000
CEHISA	D404 24	D404 224	60	55	20	2 DKN	13		43,5	12	AS1	7	2+2	14	18000
CEHISA	D404 25	D404 225	60	55	20	2 DKN	13		43,5		AS1	7	3+3	21	18000
	D404 26	D404 226	60	55	20	2 DKN					AS1	1	2+2	16	18000
	D404 27	D404 227	60	65	20	2 DKN					AS1	1	3+3	24	18000
FELDER format 4 - FRAVOL	D404 28	D404 228	60	65	25	2 DKN					AS1	1	2+2	16	18000
FELDER format 4 - FRAVOL	D404 29	D404 229	60	65	25	2 DKN					AS1	1	3+3	24	18000
	D404 30	D404 230	60	65	25	2 DKN	8				AS1	7	2+2	16	18000
	D404 31	D404 231	60	65	25	2 DKN	8				AS1	7	3+3	24	18000

### DIAMETER 70 ANGLE AXIAL 20°

Macchina Machine	Cod. DX / RH	Cod. SX / LH	ø D mm	B mm	ø d mm	DKN	See drawings pag. 118				AS1 S1	Type	Z	Z Tot	rpm max
							A	A1	T	C					
	D404 32	D404 232	70	45	30	2 DKN	16				AS1	6	2+2	12	18000
	D404 33	D404 233	70	45	30	2 DKN	16				AS1	6	3+3	18	18000
HOLZ-HER	D404 34	D404 234	70	48	30	2 DKN	9	9	24	6	AS1	10	2+2	12	18000
HOLZ-HER	D404 35	D404 235	70	48	30	2 DKN	9	9	24	6	AS1	10	3+3	18	18000
HOLZ-HER - ARCUS 1801	D404 36	D404 236	70	48	30	2 DKN	9		41	6	AS1	2	2+2	12	18000
HOLZ-HER - ARCUS 1801	D404 37	D404 237	70	48	30	2 DKN	9		41	6	AS1	2	3+3	18	18000
	D404 38	D404 238	70	48	30	2 DKN	8				AS1	7	2+2	12	18000
	D404 39	D404 239	70	48	30	2 DKN	8				AS1	7	3+3	18	18000
Hebrock	D404 40	D404 240	70	48	25	2 DKN	12		61		AS1	6	2+2	12	18000
Hebrock	D404 41	D404 241	70	48	25	2 DKN	12		61		AS1	6	3+3	18	18000
	D404 42	D404 242	70	48	25	2 DKN	11		70	11	AS1	3	2+2	12	18000
	D404 43	D404 243	70	48	25	2 DKN	11		70	11	AS1	3	3+3	18	18000
HOLZ-HER aggregate 1801	D404 44	D404 244	70	55	30	2 DKN	9,5	9	30,5	6	AS1	10	2+2	14	18000
HOLZ-HER aggregate 1801	D404 45	D404 245	70	55	30	2 DKN	9,5	9	30,5	6	AS1	10	3+3	21	18000
HOLZ-HER - ARCUS 1801	D404 46	D404 246	70	65	30	2 DKN	9,5	9	40,5	6	AS1	10	2+2	16	18000
HOLZ-HER - ARCUS 1801	D404 47	D404 247	70	65	30	2 DKN	9,5	9	40,5	6	AS1	10	3+3	24	18000

## DIAMETER 80 ANGLE AXIAL 30°

Macchina Machine	Cod. DX / RH	Cod. SX / LH	ø D mm	B mm	ø d mm	DKN	See drawings pag. 118					Z	Z Tot	rpm max	
							A	A1	T	C	AS1 S1				Type
	D404 48	D404 248	80	25	30	2 DKN					AS1	1	2 + 2	6	18000
	D404 49	D404 249	80	25	30	2 DKN					AS1	1	3 + 3	9	18000
AKRON 1300 / 1400 AKRON 400 / 800 ROXYL - STREMA BIESSE - JADE 240	D404 50	D404 250	80	30	30	2 DKN	11,5		53	11,5	S1	3	2 + 2	8	18000
AKRON 1300 / 1400 AKRON 400 / 800 ROXYL - STREMA BIESSE - JADE 240	D404 51	D404 251	80	30	30	2 DKN	11,5		53	11,5	S1	3	3 + 3	12	18000
SCM	D404 52	D404 252	80	40	30	2 DKN					AS1	1	2 + 2	10	18000
SCM	D404 53	D404 253	80	40	30	2 DKN					AS1	1	3 + 3	15	18000
AKRON 1300 / 1400 AKRON 400 / 800 ROXYL - STREMA BIESSE - JADE 240	D404 54	D404 254	80	45	30	2 DKN	4		53	4	S1	3	2 + 2	12	18000
AKRON 1300 / 1400 AKRON 400 / 800 ROXYL - STREMA BIESSE - JADE 240	D404 55	D404 255	80	45	30	2 DKN	4		53	4	S1	3	3 + 3	18	18000
	D404 56	D404 256	80	48	30	2 DKN					AS1	1	2 + 2	12	18000
	D404 57	D404 257	80	48	30	2 DKN					AS1	1	3 + 3	18	18000
FELDER	D404 58	D404 258	80	48	30	2 DKN	15		63		AS1	6	2 + 2	12	18000
FELDER	D404 59	D404 259	80	48	30	2 DKN	15		63		AS1	6	3 + 3	18	18000
BIESSE AK - RON 246	D404 60	D404 260	80	48	20	2 DKN	11,5		25	11,5	S	2	2 + 2	12	18000
BIESSE AK - RON 246	D404 61	D404 261	80	48	20	2 DKN	11,5		25	11,5	S	2	3 + 3	18	18000
SCM ME-35 - MINIMAX	D404 62	D404 262	80	55	30	2 DKN					AS1	1	2 + 2	14	18000
SCM ME-35 - MINIMAX	D404 63	D404 263	80	55	30	2 DKN					AS1	1	3 + 3	21	18000
BIESSE AK RON 246 GRIGGIO	D404 64	D404 264	80	55	20	2 DKN	17		25	13	AS1	2	2 + 2	14	18000
BIESSE AK RON 246 GRIGGIO	D404 65	D404 265	80	55	20	2 DKN	17		25	13	AS1	2	3 + 3	21	18000
	D404 66	D404 266	80	65	25	2 DKN					AS1	1	2 + 2	16	18000
	D404 67	D404 267	80	65	25	2 DKN					AS1	1	3 + 3	24	18000
AKRON 1300 / 1400 AKRON 400 / 800 ROXYL - STREMA BIESSE - JADE 240	D404 68	D404 268	80	65	30	2 DKN	6		53	6	S1	2	2 + 2	16	18000
AKRON 1300 / 1400 AKRON 400 / 800 ROXYL - STREMA BIESSE - JADE 240	D404 69	D404 269	80	65	30	2 DKN	6		53	6	S1	2	3 + 3	24	18000
	D404 70	D404 270	80	65	30	2 DKN	10		56		AS1	7	2 + 2	16	18000
	D404 71	D404 271	80	65	30	2 DKN	10		56		AS1	7	3 + 3	24	18000
GRIGGIO	D404 72	D404 272	80	65	30	2 DKN	28		25	12	AS1	2	2 + 2	16	18000
GRIGGIO	D404 73	D404 273	80	65	30	2 DKN	28		25	12	AS1	2	3 + 3	24	18000
CEHISA	D404 74	D404 274	80	65	20	2 DKN	21,5		37	6,5	AS1	2	2 + 2	16	18000
CEHISA	D404 75	D404 275	80	65	20	2 DKN	21,5		37	6,5	AS1	2	3 + 3	24	18000

## DIAMETER 85 ANGLE AXIAL 30°

Macchina Machine	Cod. DX / RH	Cod. SX / LH	ø D mm	B mm	ø d mm	DKN	See drawings pag. 118					Z	Z Tot	rpm max	
							A	A1	T	C	AS1 S1				Type
OTT	D404 76	D404 276	85	45	30	2 DKN					AS1	1	3 + 3	24	18000
OTT	D404 77	D404 277	85	65	30	2 DKN	15				AS1	7	3 + 3	24	18000

## DIAMETER 100 ANGLE AXIAL 30°

Macchina Machine	Cod. DX / RH	Cod. SX / LH	ø D mm	B mm	ø d mm	DKN	See drawings pag. 118				AS1 S1	Type	Z	Z Tot	rpm max
							A	A1	T	C					
IMA - BRANDT	D404 78	D404 278	100	35	30	2 DKN					S1	1	2 + 2	8	18000
IMA - BRANDT	D404 79	D404 279	100	35	30	2 DKN					S1	1	3 + 3	12	18000
	D404 80	D404 280	100	45	30	2 DKN					AS1	1	2 + 2	12	18000
	D404 81	D404 281	100	45	30	2 DKN					AS1	1	3 + 3	18	18000
	D404 82	D404 282	100	45	30	2 DKN					S1	1	2 + 2	12	18000
	D404 83	D404 283	100	45	30	2 DKN					S1	1	3 + 3	18	18000
BRANDT	D404 84	D404 284	100	45	30	2 DKN	5,4		40,6		AS1	7	2 + 2	12	18000
BRANDT	D404 85	D404 285	100	45	30	2 DKN	5,4		40,6		AS1	7	3 + 3	18	18000
HEBROCK - EBM - BRANDT AMBITION - 1110 F	D404 86	D404 286	100	45	30	2 DKN	16		61		AS1	6	2 + 2	12	18000
HEBROCK - EBM - BRANDT AMBITION - 1110 F	D404 87	D404 287	100	45	30	2 DKN	16		61		AS1	6	3 + 3	18	18000
	D404 88	D404 288	100	45	30	2 DKN	12		75	15	AS1	3	2 + 2	12	18000
	D404 89	D404 289	100	45	30	2 DKN	12		75	15	AS1	3	3 + 3	18	18000
	D404 90	D404 290	100	48	25	2 DKN					AS1	1	2 + 2	12	18000
	D404 91	D404 291	100	48	25	2 DKN					AS1	1	3 + 3	18	18000
HOLZ-HER - UPTO 2008 . SCM	D404 92	D404 292	100	48	30	2 DKN	11,5		25	11,5	AS1	2	2 + 2	12	18000
HOLZ-HER - UPTO 2008 . SCM	D404 93	D404 293	100	48	30	2 DKN	11,5		25	11,5	AS1	2	3 + 3	18	18000
BRANDT - IMA - SCM K360 - K560 - IDM - BIESSE	D404 94	D404 294	100	48	30	2 DKN	7,4		40,6		AS1	7	2 + 2	12	18000
BRANDT - IMA - SCM K360 - K560 - IDM - BIESSE	D404 95	D404 295	100	48	30	2 DKN	7,4		40,6		AS1	7	3 + 3	18	18000
BRANDT - IMA - SCM K360 - K560 - IDM - BIESSE	D404 96	D404 296	100	48	30	2 DKN	4		40	4	AS1	2	2 + 2	12	18000
BRANDT - IMA - SCM K360 - K560 - IDM - BIESSE	D404 97	D404 297	100	48	30	2 DKN	4		40	4	AS1	2	3 + 3	18	18000
	D404 98	D404 298	100	55	30	2 DKN					AS1	1	2 + 2	14	18000
	D404 99	D404 299	100	55	30	2 DKN					AS1	1	3 + 3	21	18000
HOLZ-HER UP TO 2008 - SCM	D404 100	D404 300	100	55	30	2 DKN	18,5		25	11,5	AS1	2	2 + 2	14	18000
HOLZ-HER UP TO 2008 - SCM	D404 101	D404 301	100	55	30	2 DKN	18,5		25	11,5	AS1	2	3 + 3	21	18000
BRANDT - IMA - SCM K360 - K560 - IDM - BIESSE	D404 102	D404 302	100	55	30	2 DKN	14,4		40,6		AS1	7	2 + 2	14	18000
BRANDT - IMA - SCM K360 - K560 - IDM - BIESSE	D404 103	D404 303	100	55	30	2 DKN	14,4		40,6		AS1	7	3 + 3	21	18000
	D404 104	D404 304	100	65	30	2 DKN					AS1	1	2 + 2	16	18000
	D404 105	D404 305	100	65	30	2 DKN					AS1	1	3 + 3	24	18000
BIESSE AKRON 600 - AKRON 800	D404 106	D404 306	100	65	30	2 DKN	5		75	5	S1	3	2 + 2	16	18000
BIESSE AKRON 600 - AKRON 800	D404 107	D404 307	100	65	30	2 DKN	5		75	5	S1	3	3 + 3	24	18000
BRANDT - IMA - SCM K360 - K560 - IDM - BIESSE	D404 108	D404 308	100	65	30	2 DKN	25,4		40,6		AS1	7	2 + 2	16	18000
BRANDT - IMA - SCM K360 - K560 - IDM - BIESSE	D404 109	D404 309	100	65	30	2 DKN	25,4		40,6		AS1	7	3 + 3	24	18000
HOLZ-HER UP TO 2008 - SCM	D404 110	D404 310	100	65	30	2 DKN	12		26	27	AS1	2	2 + 2	16	18000
HOLZ-HER UP TO 2008 - SCM	D404 111	D404 311	100	65	30	2 DKN	12		26	27	AS1	2	3 + 3	24	18000
CEHISA	D404 112	D404 312	100	65	20	2 DKN	21,5		37	6,5	AS1	2	2 + 2	16	18000
CEHISA	D404 113	D404 313	100	65	20	2 DKN	21,5		37	6,5	AS1	2	3 + 3	24	18000
HOLZ-HER	D404 114	D404 314	100	65	30	2 DKN	16		40	9	AS1	2	2 + 2	16	18000
HOLZ-HER	D404 115	D404 315	100	65	30	2 DKN	16		40	9	AS1	2	3 + 3	24	18000



## DIAMETER 125 ANGLE AXIAL 30°

Macchina Machine	Cod. DX / RH	Cod. SX / LH	ø D mm	B mm	ø d mm	DKN	See drawings pag. 118				AS1 S1	Type	Z	Z Tot	rpm max
							A	A1	T	C					
IMA - HOMAG	D404 116	D404 316	125	34	30	2 DKN					AS1	1	3 + 3	12	15000
IMA - HOMAG	D404 117	D404 317	125	34	30	2 DKN					AS1	1	4 + 4	16	15000
	D404 118	D404 318	125	43	30	2 DKN	14		57		AS1	6	3 + 3	18	15000
	D404 119	D404 319	125	43	30	2 DKN	14		57		AS1	6	4 + 4	24	15000
IMA - BIESSE	D404 120	D404 320	125	45	30	2 DKN					AS1	1	3 + 3	18	15000
IMA - BIESSE	D404 121	D404 321	125	45	30	2 DKN					AS1	1	4 + 4	24	15000
HOMAG - BIESSE	D404 122	D404 322	125	45	30	2 DKN	6				AS1	7	3 + 3	18	15000
HOMAG - BIESSE	D404 123	D404 323	125	45	30	2 DKN	6				AS1	7	4 + 4	24	15000
BIESSE	D404 124	D404 324	125	48	30	2 DKN					AS1	1	3 + 3	18	15000
BIESSE	D404 125	D404 325	125	48	30	2 DKN					AS1	1	4 + 4	24	15000
HOMAG	D404 126	D404 326	125	48	30	2 DKN	4		40	4	AS1	2	3 + 3	18	15000
HOMAG	D404 127	D404 327	125	48	30	2 DKN	4		40	4	AS1	2	4 + 4	24	15000
	D404 128	D404 328	125	65	30	2 DKN					AS1	1	3 + 3	24	15000
	D404 129	D404 329	125	65	30	2 DKN					AS1	1	4 + 4	32	15000
BIESSE	D404 130	D404 330	125	65	30	2 DKN	8		49	8	AS1	2	3 + 3	24	15000
BIESSE	D404 131	D404 331	125	65	30	2 DKN	8		49	8	AS1	2	4 + 4	32	15000
BRANDT - IMA - SCM IDM - BIESSE	D404 132	D404 332	125	65	30	2 DKN	25,4		40,6		AS1	7	3 + 3	24	15000
BRANDT - IMA - SCM IDM - BIESSE	D404 133	D404 333	125	65	30	2 DKN	25,4		40,6		AS1	7	4 + 4	32	15000
HOMAG	D404 134	D404 334	125	65	30	2 DKN	12,5		40	12,5	AS1	2	3 + 3	24	15000
HOMAG	D404 135	D404 335	125	65	30	2 DKN	12,5		40	12,5	AS1	2	4 + 4	32	15000
GRIGGIO - HOLZ-HER	D404 136	D404 336	125	65	30	2 DKN	28		25	12	AS1	2	3 + 3	24	15000
GRIGGIO - HOLZ-HER	D404 137	D404 337	125	65	30	2 DKN	28		25	12	AS1	2	4 + 4	32	15000

## DIAMETER 150 ANGLE AXIAL 30°

Macchina Machine	Cod. DX / RH	Cod. SX / LH	ø D mm	B mm	ø d mm	DKN	See drawings pag. 118				AS1 S1	Type	Z	Z Tot	rpm max
							A	A1	T	C					
HOMAG	D404 138	D404 338	150	43	30	2 DKN	1,5		40	1,5	AS1	2	3 + 3	18	15000
HOMAG	D404 139	D404 339	150	43	30	2 DKN	1,5		40	1,5	AS1	2	4 + 4	24	15000
HOMAG	D404 140	D404 340	150	65	30	2 DKN	13,75		40	13,75	AS1	2	3 + 3	24	15000
HOMAG	D404 141	D404 341	150	65	30	2 DKN	13,75		40	13,75	AS1	2	4 + 4	32	15000



**S1**  
DISPOSIZIONE SIMMETRICA  
SYMMETRIC TIP ARRANGEMENT

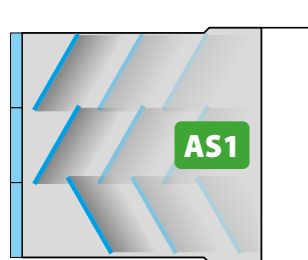

**AS1**  
DISPOSIZIONE ASIMMETRICA  
ASYMMETRIC TIP ARRANGEMENT

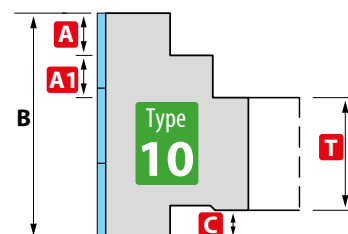
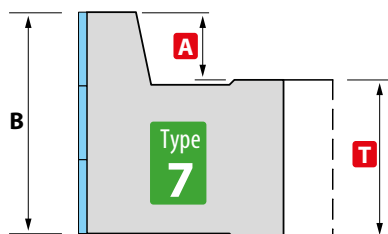
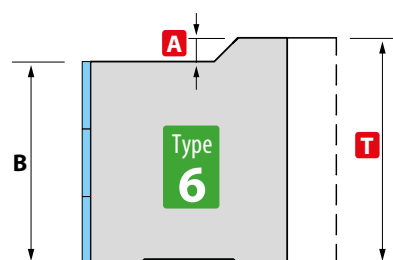
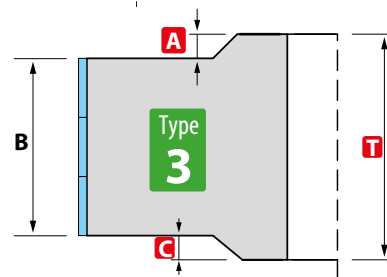
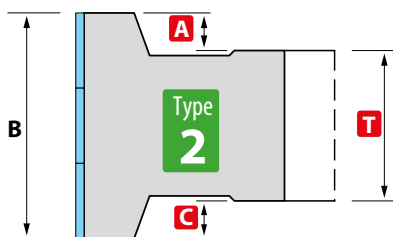
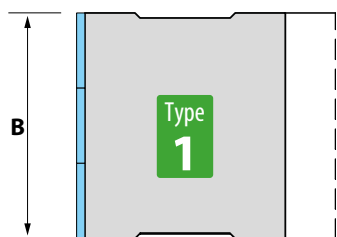

Section  
INDEX

Anti-splinter DP diamond cutter for edgebander, H4.5mm, with 45° axial angles

Diamant-Fügefräser für Kantenanleimmaschine PKD H 4,5 mm mit Achswinkel 45°

Fresa de diamante antiastillante con plaquita en DP de H 4,5 mm y ángulos axiales de 45° para canteadora

Fraise en diamant anti éclat pour plaqueuse de chant, DP H4,5 mm avec angle axial 45°

Алмазная фреза (анти-сколов) для кромкооблицовочного станка DP H4.5mm, осевые углы 45°

INDEX  
by article



PRICE LIST

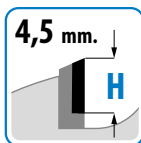

ANGOLO ASSIALE  
AXIAL ANGLE



+ NEGATIV



Costruite con corpo in acciaio speciale in Z=2+2/3+3 DP H4.5mm, assialità 45° disegno asimmetrico e simmetrico per ottenere un'ottima qualità di lavorazione, finitura e scarico del truciolo

Manufactured with body of special steel, Z=2+2/3+3, DP, H4.5mm, 45° axial angle, asymmetrical and symmetrical pattern, to give optimum quality of machining, finishing and chip removal.

Hergestellt mit Körper aus Sonderstahl in Z=2+2/3+3 PKD H 4,5 mm, Achswinkel 45°, asymmetrisches und symmetrisches Design, für eine hervorragende Bearbeitungsqualität, Oberflächengüte und Spanabfuhr

Cuenta con cuerpo de acero especial Z=2+2/3+3 con plaquita en DP de H 4,5 mm, ángulos axiales de 45°, diseño asimétrico y simétrico, para obtener una excelente calidad de mecanizado, acabado y descarga de la viruta.

Construite avec corps en acier spécial en Z2+2/3+3, DP H4,5 mm, axialité 45°, dessin symétrique et asymétrique pour obtenir une qualité d'usinage optimale, finition et écoulement du copeau.

Корпус из специальной стали Z=2+2/3+3 DP H4.5mm, угол 45°, асимметричный и симметричный дизайн позволяет получить отличное качество обработки, отделки и удаления стружки

DIAMETER 80

ANGLE AXIAL 45°

Macchina Machine	Cod. DX / RH	Cod. SX / LH	ø D mm	B mm	ø d mm	DKN	See drawings pag. 121				AS1 S1	Type	Z	Z Tot	rpm max
							A	A1	T	C					
	D413 10	D413 210	80	25	30	2 DKN					AS1	1	2+2	6	18000
	D413 11	D413 211	80	25	30	2 DKN					AS1	1	3+3	9	18000
AKRON 1300 / 1400 AKRON 400 / 800 ROXYL - STREMA BIESSE - JADE 240	D413 12	D413 212	80	30	30	2 DKN	11,5		53	11,5	S1	3	2+2	8	18000
AKRON 1300 / 1400 AKRON 400 / 800 ROXYL - STREMA BIESSE - JADE 240	D413 13	D413 213	80	30	30	2 DKN	11,5		53	11,5	S1	3	3+3	12	18000
SCM	D413 14	D413 214	80	40	30	2 DKN					AS1	1	2+2	10	18000
SCM	D413 15	D413 215	80	40	30	2 DKN					AS1	1	3+3	15	18000
AKRON 1300 / 1400 AKRON 400 / 800 ROXYL - STREMA BIESSE - JADE 240	D413 16	D413 216	80	45	30	2 DKN	4		53	4	S1	3	2+2	12	18000
AKRON 1300 / 1400 AKRON 400 / 800 ROXYL - STREMA BIESSE - JADE 240	D413 17	D413 217	80	45	30	2 DKN	4		53	4	S1	3	3+3	18	18000
	D413 18	D413 218	80	48	30	2 DKN					AS1	1	2+2	12	18000
	D413 19	D413 219	80	48	30	2 DKN					AS1	1	3+3	18	18000
FELDER	D413 20	D413 220	80	48	30	2 DKN	15		63		AS1	6	2+2	12	18000
FELDER	D413 21	D413 221	80	48	30	2 DKN	15		63		AS1	6	3+3	18	18000
BIESSE AK - RON 246	D413 22	D413 222	80	48	20	2 DKN	11,5		25	11,5	S	2	2+2	12	18000
BIESSE AK - RON 246	D413 23	D413 223	80	48	20	2 DKN	11,5		25	11,5	S	2	3+3	18	18000
SCM ME-35 - MINIMAX	D413 24	D413 224	80	55	30	2 DKN					AS1	1	2+2	14	18000
SCM ME-35 - MINIMAX	D413 25	D413 225	80	55	30	2 DKN					AS1	1	3+3	21	18000
BIESSE AK RON 246 GRIGGIO	D413 26	D413 226	80	55	20	2 DKN	17		25	13	AS1	2	2+2	14	18000
BIESSE AK RON 246 GRIGGIO	D413 27	D413 227	80	55	20	2 DKN	17		25	13	AS1	2	3+3	21	18000
	D413 28	D413 228	80	65	25	2 DKN					AS1	1	2+2	16	18000
	D413 29	D413 229	80	65	25	2 DKN					AS1	1	3+3	24	18000
AKRON 1300 / 1400 AKRON 400 / 800 ROXYL - STREMA BIESSE - JADE 240	D413 30	D413 230	80	65	30	2 DKN	6		53	6	S1	2	2+2	16	18000
AKRON 1300 / 1400 AKRON 400 / 800 ROXYL - STREMA BIESSE - JADE 240	D413 31	D413 231	80	65	30	2 DKN	6		53	6	S1	2	3+3	24	18000
	D413 32	D413 232	80	65	30	2 DKN	10		56		AS1	7	2+2	16	18000
	D413 33	D413 233	80	65	30	2 DKN	10		56		AS1	7	3+3	24	18000
GRIGGIO	D413 34	D413 234	80	65	30	2 DKN	28		25	12	AS1	2	2+2	16	18000
GRIGGIO	D413 35	D413 235	80	65	30	2 DKN	28		25	12	AS1	2	3+3	24	18000
CEHISA	D413 36	D413 236	80	65	20	2 DKN	21,5		37	6,5	AS1	2	2+2	16	18000
CEHISA	D413 37	D413 237	80	65	20	2 DKN	21,5		37	6,5	AS1	2	3+3	24	18000



## DIAMETER 85

## ANGLE AXIAL 45°

Macchina Machine	Cod. DX / RH	Cod. SX / LH	ø D mm	B mm	ø d mm	DKN	See drawings pag. 121				AS1 S1	Type	Z	Z Tot	rpm max
							A	A1	T	C					
OTT	D413 38	D413 238	85	45	30	2 DKN					AS1	1	3 + 3	24	18000
OTT	D413 39	D413 239	85	65	30	2 DKN	15				AS1	7	3 + 3	24	18000

## DIAMETER 100

## ANGLE AXIAL 45°

Macchina Machine	Cod. DX / RH	Cod. SX / LH	ø D mm	B mm	ø d mm	DKN	See drawings pag. 121				AS1 S1	Type	Z	Z Tot	rpm max
							A	A1	T	C					
IMA - BRANDT	D413 40	D413 240	100	35	30	2 DKN					S1	1	2 + 2	8	18000
IMA - BRANDT	D413 41	D413 241	100	35	30	2 DKN					S1	1	3 + 3	12	18000
	D413 42	D413 242	100	45	30	2 DKN					AS1	1	2 + 2	12	18000
	D413 43	D413 243	100	45	30	2 DKN					AS1	1	3 + 3	18	18000
	D413 44	D413 244	100	45	30	2 DKN					S1	1	2 + 2	12	18000
	D413 45	D413 245	100	45	30	2 DKN					S1	1	3 + 3	18	18000
BRANDT	D413 46	D413 246	100	45	30	2 DKN	5,4		40,6		AS1	7	2 + 2	12	18000
BRANDT	D413 47	D413 247	100	45	30	2 DKN	5,4		40,6		AS1	7	3 + 3	18	18000
HEBROCK - EBM - BRANDT AMBITION - 1110 F	D413 48	D413 248	100	45	30	2 DKN	16		61		AS1	6	2 + 2	12	18000
HEBROCK - EBM - BRANDT AMBITION - 1110 F	D413 49	D413 249	100	45	30	2 DKN	16		61		AS1	6	3 + 3	18	18000
	D413 50	D413 250	100	45	30	2 DKN	12		75	15	AS1	3	2 + 2	12	18000
	D413 51	D413 251	100	45	30	2 DKN	12		75	15	AS1	3	3 + 3	18	18000
	D413 52	D413 252	100	48	25	2 DKN					AS1	1	2 + 2	12	18000
	D413 53	D413 253	100	48	25	2 DKN					AS1	1	3 + 3	18	18000
HOLZ-HER - UPTO 2008 - SCM	D413 54	D413 254	100	48	30	2 DKN	11,5		25	11,5	AS1	2	2 + 2	12	18000
HOLZ-HER - UPTO 2008 - SCM	D413 55	D413 255	100	48	30	2 DKN	11,5		25	11,5	AS1	2	3 + 3	18	18000
BRANDT - IMA - SCM K360 - K560 - IDM - BIESSE	D413 56	D413 256	100	48	30	2 DKN	7,4		40,6		AS1	7	2 + 2	12	18000
BRANDT - IMA - SCM K360 - K560 - IDM - BIESSE	D413 57	D413 257	100	48	30	2 DKN	7,4		40,6		AS1	7	3 + 3	18	18000
BRANDT - IMA - SCM K360 - K560 - IDM - BIESSE	D413 58	D413 258	100	48	30	2 DKN	4		40	4	AS1	2	2 + 2	12	18000
BRANDT - IMA - SCM K360 - K560 - IDM - BIESSE	D413 59	D413 259	100	48	30	2 DKN	4		40	4	AS1	2	3 + 3	18	18000
	D413 60	D413 260	100	55	30	2 DKN					AS1	1	2 + 2	14	18000
	D413 61	D413 261	100	55	30	2 DKN					AS1	1	3 + 3	21	18000
HOLZ-HER UP TO 2008 - SCM	D413 62	D413 262	100	55	30	2 DKN	18,5		25	11,5	AS1	2	2 + 2	14	18000
HOLZ-HER UP TO 2008 - SCM	D413 63	D413 263	100	55	30	2 DKN	18,5		25	11,5	AS1	2	3 + 3	21	18000
BRANDT - IMA - SCM K360 - K560 - IDM - BIESSE	D413 64	D413 264	100	55	30	2 DKN	14,4		40,6		AS1	7	2 + 2	14	18000
BRANDT - IMA - SCM K360 - K560 - IDM - BIESSE	D413 65	D413 265	100	55	30	2 DKN	14,4		40,6		AS1	7	3 + 3	21	18000
	D413 66	D413 266	100	65	30	2 DKN					AS1	1	2 + 2	16	18000
	D413 67	D413 267	100	65	30	2 DKN					AS1	1	3 + 3	24	18000
BIESSE AKRON 600 - AKRON 800	D413 68	D413 268	100	65	30	2 DKN	5		75	5	S1	3	2 + 2	16	18000
BIESSE AKRON 600 - AKRON 800	D413 69	D413 269	100	65	30	2 DKN	5		75	5	S1	3	3 + 3	24	18000
BRANDT - IMA - SCM K360 - K560 - IDM - BIESSE	D413 70	D413 270	100	65	30	2 DKN	25,4		40,6		AS1	7	2 + 2	16	18000
BRANDT - IMA - SCM K360 - K560 - IDM - BIESSE	D413 71	D413 271	100	65	30	2 DKN	25,4		40,6		AS1	7	3 + 3	24	18000
HOLZ-HER UP TO 2008 - SCM	D413 72	D413 272	100	65	30	2 DKN	12		26	27	AS1	2	2 + 2	16	18000
HOLZ-HER UP TO 2008 - SCM	D413 73	D413 273	100	65	30	2 DKN	12		26	27	AS1	2	3 + 3	24	18000
CEHISA	D413 74	D413 274	100	65	20	2 DKN	21,5		37	6,5	AS1	2	2 + 2	16	18000
CEHISA	D413 75	D413 275	100	65	20	2 DKN	21,5		37	6,5	AS1	2	3 + 3	24	18000
HOLZ-HER	D413 76	D413 276	100	65	30	2 DKN	16		40	9	AS1	2	2 + 2	16	18000
HOLZ-HER	D413 77	D413 277	100	65	30	2 DKN	16		40	9	AS1	2	3 + 3	24	18000



## DIAMETER 125 ANGLE AXIAL 45°

Macchina Machine	Cod. DX / RH	Cod. SX / LH	ø D mm	B mm	ø d mm	DKN	See drawings pag. 121				AS1 S1	Type	Z	Z Tot	rpm max
							A	A1	T	C					
IMA - HOMAG	D413 78	D413 278	125	34	30	2 DKN					AS1	1	3+3	12	15000
IMA - HOMAG	D413 79	D413 279	125	34	30	2 DKN					AS1	1	4+4	16	15000
	D413 80	D413 280	125	43	30	2 DKN	14		57		AS1	6	3+3	18	15000
	D413 81	D413 281	125	43	30	2 DKN	14		57		AS1	6	4+4	24	15000
IMA - BIESSE	D413 82	D413 282	125	45	30	2 DKN					AS1	1	3+3	18	15000
IMA - BIESSE	D413 83	D413 283	125	45	30	2 DKN					AS1	1	4+4	24	15000
HOMAG - BIESSE	D413 84	D413 284	125	45	30	2 DKN	6				AS1	7	3+3	18	15000
HOMAG - BIESSE	D413 85	D413 285	125	45	30	2 DKN	6				AS1	7	4+4	24	15000
BIESSE	D413 86	D413 286	125	48	30	2 DKN					AS1	1	3+3	18	15000
BIESSE	D413 87	D413 287	125	48	30	2 DKN					AS1	1	4+4	24	15000
HOMAG	D413 88	D413 288	125	48	30	2 DKN	4		40	4	AS1	2	3+3	18	15000
HOMAG	D413 89	D413 289	125	48	30	2 DKN	4		40	4	AS1	2	4+4	24	15000
	D413 90	D413 290	125	65	30	2 DKN					AS1	1	3+3	24	15000
	D413 91	D413 291	125	65	30	2 DKN					AS1	1	4+4	32	15000
BIESSE	D413 92	D413 292	125	65	30	2 DKN	8		49	8	AS1	2	3+3	24	15000
BIESSE	D413 93	D413 293	125	65	30	2 DKN	8		49	8	AS1	2	4+4	32	15000
BRANDT - IMA - SCM IDM - BIESSE	D413 94	D413 294	125	65	30	2 DKN	25,4		40,6		AS1	7	3+3	24	15000
BRANDT - IMA - SCM IDM - BIESSE	D413 95	D413 295	125	65	30	2 DKN	25,4		40,6		AS1	7	4+4	32	15000
HOMAG	D413 96	D413 296	125	65	30	2 DKN	12,5		40	12,5	AS1	2	3+3	24	15000
HOMAG	D413 97	D413 297	125	65	30	2 DKN	12,5		40	12,5	AS1	2	4+4	32	15000
GRIGGIO - HOLZ-HER	D413 98	D413 298	125	65	30	2 DKN	28		25	12	AS1	2	3+3	24	15000
GRIGGIO - HOLZ-HER	D413 99	D413 299	125	65	30	2 DKN	28		25	12	AS1	2	4+4	32	15000

## DIAMETER 150 ANGLE AXIAL 45°

Macchina Machine	Cod. DX / RH	Cod. SX / LH	ø D mm	B mm	ø d mm	DKN	See drawings pag. 121				AS1 S1	Type	Z	Z Tot	rpm max
							A	A1	T	C					
HOMAG	D413 100	D413 300	150	43	30	2 DKN	1,5		40	1,5	AS1	2	3+3	18	15000
HOMAG	D413 101	D413 301	150	43	30	2 DKN	1,5		40	1,5	AS1	2	4+4	24	15000
HOMAG	D413 102	D413 302	150	65	30	2 DKN	13,75		40	13,75	AS1	2	3+3	24	15000
HOMAG	D413 103	D413 303	150	65	30	2 DKN	13,75		40	13,75	AS1	2	4+4	32	15000



**S1**  
DISPOSIZIONE SIMMETRICA  
SYMMETRIC TIP ARRANGEMENT



**AS1**  
DISPOSIZIONE ASIMMETRICA  
ASYMMETRIC TIP ARRANGEMENT

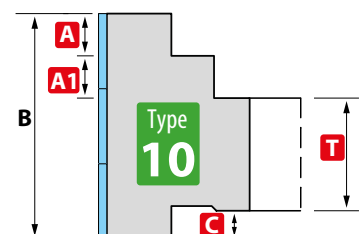
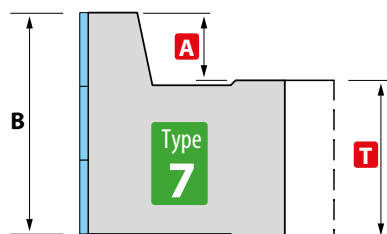
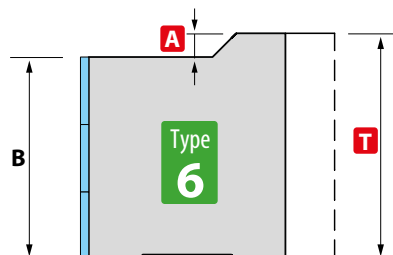
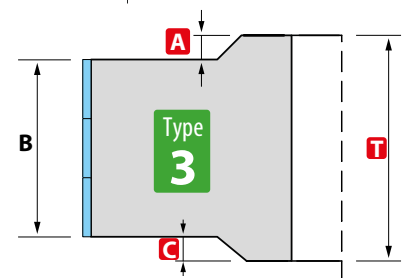
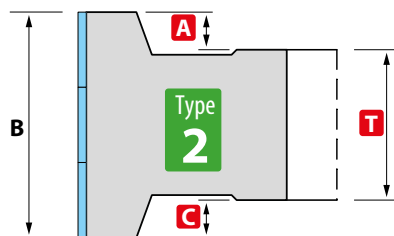
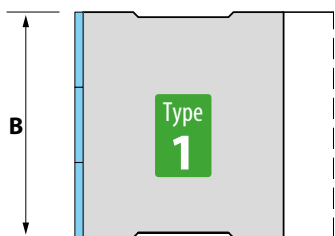

Anti-splinter DP diamond cutter for edgebander, H4.5mm, with 54.9° axial angles

Diamant-Fügefräser für Kantenanleimmaschine PKD H 4,5 mm mit Achswinkel 54,9°

Fresa de diamante antiastillante con plaquita en DP de H 4,5 mm y ángulos axiales de 54,9° para canteadora

Fraise en diamant anti éclat pour plaqueuse de chant, DP H4,5 mm avec angle axial 54,9°

Алмазная фреза (анти-сколов) для кромооблицовочного станка DP H4.5mm осевые углы 54,9°



PRICE LIST

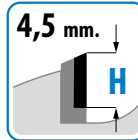
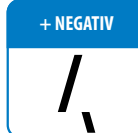

Costruite con corpo in acciaio speciale Z=2+2/3+3 DP H4.5mm, assialità 54,9° disegno asimmetrico e simmetrico, per ottenere un'ottima qualità di lavorazione, finitura e scarico del truciolo

Manufactured with body of special steel, Z=2+2/3+3, DP, H4.5mm, 54.9° axial angle, asymmetrical and symmetrical pattern, to give optimum quality of machining, finishing and chip removal

Hergestellt mit Körper aus Sonderstahl Z=2+2/3+3 PKD H 4,5 mm, Achswinkel 54,9°, asymmetrisches und symmetrisches Design, für eine hervorragende Bearbeitungsqualität, Oberflächengüte und Spanabfuhr

Cuenta con cuerpo de acero especial Z=2+2/3+3 con plaquita en DP de H 4,5 mm, ángulos axiales de 54,9°, diseño asimétrico y simétrico, para obtener una excelente calidad de mecanizado, acabado y descarga de la viruta.

Construite avec corps en acier spécial en Z2+2/3+3, DP H4,5 mm, axialité 54,9°, dessin symétrique et asymétrique pour obtenir une qualité d'usinage optimale, finition et écoulement du copeau.

Корпус из специальной стали Z=2+2/3+3 DP H4.5mm, угол 54,9° ассиметричный и симметричный дизайн позволяет получить отличное качество обработки, отделки и удаления стружки



### DIAMETER 100 ANGLE AXIAL 54,9°

Macchina Machine	Cod. DX / RH	Cod. SX / LH	ø D mm	B mm	ø d mm	DKN	See drawings pag. 123				AS1 S1	Type	Z	Z Tot	rpm max
							A	A1	T	C					
IMA - BRANDT	D419 10	D419 210	100	35	30	2 DKN					S1	1	2 + 2	8	18000
IMA - BRANDT	D419 11	D419 211	100	35	30	2 DKN					S1	1	3 + 3	12	18000
	D419 12	D419 212	100	45	30	2 DKN					AS1	1	2 + 2	12	18000
	D419 13	D419 213	100	45	30	2 DKN					AS1	1	3 + 3	18	18000
	D419 14	D419 214	100	45	30	2 DKN					S1	1	2 + 2	12	18000
	D419 15	D419 215	100	45	30	2 DKN					S1	1	3 + 3	18	18000
BRANDT	D419 16	D419 216	100	45	30	2 DKN	5,4		40,6		AS1	7	2 + 2	12	18000
BRANDT	D419 17	D419 217	100	45	30	2 DKN	5,4		40,6		AS1	7	3 + 3	18	18000
HEBROCK - EBM - BRANDT AMBITION - 1110 F	D419 18	D419 218	100	45	30	2 DKN	16		61		AS1	6	2 + 2	12	18000
HEBROCK - EBM - BRANDT AMBITION - 1110 F	D419 19	D419 219	100	45	30	2 DKN	16		61		AS1	6	3 + 3	18	18000
	D419 20	D419 220	100	45	30	2 DKN	12		75	15	AS1	3	2 + 2	12	18000
	D419 21	D419 221	100	45	30	2 DKN	12		75	15	AS1	3	3 + 3	18	18000
	D419 22	D419 222	100	48	25	2 DKN					AS1	1	2 + 2	12	18000
	D419 23	D419 223	100	48	25	2 DKN					AS1	1	3 + 3	18	18000
HOLZ-HER - UPTO 2008 - SCM	D419 24	D419 224	100	48	30	2 DKN	11,5		25	11,5	AS1	2	2 + 2	12	18000
HOLZ-HER - UPTO 2008 - SCM	D419 25	D419 225	100	48	30	2 DKN	11,5		25	11,5	AS1	2	3 + 3	18	18000
BRANDT - IMA - SCM K360 - K560 - IDM - BIESSE	D419 26	D419 226	100	48	30	2 DKN	7,4		40,6		AS1	7	2 + 2	12	18000
BRANDT - IMA - SCM K360 - K560 - IDM - BIESSE	D419 27	D419 227	100	48	30	2 DKN	7,4		40,6		AS1	7	3 + 3	18	18000
BRANDT - IMA - SCM K360 - K560 - IDM - BIESSE	D419 28	D419 228	100	48	30	2 DKN	4		40	4	AS1	2	2 + 2	12	18000
BRANDT - IMA - SCM K360 - K560 - IDM - BIESSE	D419 29	D419 229	100	48	30	2 DKN	4		40	4	AS1	2	3 + 3	18	18000
	D419 30	D419 230	100	55	30	2 DKN					AS1	1	2 + 2	14	18000
	D419 31	D419 231	100	55	30	2 DKN					AS1	1	3 + 3	21	18000
HOLZ-HER UP TO 2008 - SCM	D419 32	D419 232	100	55	30	2 DKN	18,5		25	11,5	AS1	2	2 + 2	14	18000
HOLZ-HER UP TO 2008 - SCM	D419 33	D419 233	100	55	30	2 DKN	18,5		25	11,5	AS1	2	3 + 3	21	18000
BRANDT - IMA - SCM K360 - K560 - IDM - BIESSE	D419 34	D419 234	100	55	30	2 DKN	14,4		40,6		AS1	7	2 + 2	14	18000
BRANDT - IMA - SCM K360 - K560 - IDM - BIESSE	D419 35	D419 235	100	55	30	2 DKN	14,4		40,6		AS1	7	3 + 3	21	18000
	D419 36	D419 236	100	65	30	2 DKN					AS1	1	2 + 2	16	18000
	D419 37	D419 237	100	65	30	2 DKN					AS1	1	3 + 3	24	18000
BIESSE AKRON 600 - AKRON 800	D419 38	D419 238	100	65	30	2 DKN	5		75	5	S1	3	2 + 2	16	18000
BIESSE AKRON 600 - AKRON 800	D419 39	D419 239	100	65	30	2 DKN	5		75	5	S1	3	3 + 3	24	18000
BRANDT - IMA - SCM K360 - K560 - IDM - BIESSE	D419 40	D419 240	100	65	30	2 DKN	25,4		40,6		AS1	7	2 + 2	16	18000
BRANDT - IMA - SCM K360 - K560 - IDM - BIESSE	D419 41	D419 241	100	65	30	2 DKN	25,4		40,6		AS1	7	3 + 3	24	18000
HOLZ-HER UP TO 2008 - SCM	D419 42	D419 242	100	65	30	2 DKN	12		26	27	AS1	2	2 + 2	16	18000
HOLZ-HER UP TO 2008 - SCM	D419 43	D419 243	100	65	30	2 DKN	12		26	27	AS1	2	3 + 3	24	18000
CEHISA	D419 44	D419 244	100	65	20	2 DKN	21,5		37	6,5	AS1	2	2 + 2	16	18000
CEHISA	D419 45	D419 245	100	65	20	2 DKN	21,5		37	6,5	AS1	2	3 + 3	24	18000
HOLZ-HER	D419 46	D419 246	100	65	30	2 DKN	16		40	9	AS1	2	2 + 2	16	18000
HOLZ-HER	D419 47	D419 247	100	65	30	2 DKN	16		40	9	AS1	2	3 + 3	24	18000

## DIAMETER 125 ANGLE AXIAL 54,9°

Macchina Machine	Cod. DX / RH	Cod. SX / LH	ø D mm	B mm	ø d mm	DKN	See drawings pag. 123				AS1 S1	Type	Z	Z Tot	rpm max
							A	A1	T	C					
IMA - HOMAG	D419 48	D419 248	125	34	30	2 DKN					AS1	1	3 + 3	12	15000
IMA - HOMAG	D419 49	D419 249	125	34	30	2 DKN					AS1	1	4 + 4	16	15000
	D419 50	D419 250	125	43	30	2 DKN	14		57		AS1	6	3 + 3	18	15000
	D419 51	D419 251	125	43	30	2 DKN	14		57		AS1	6	4 + 4	24	15000
IMA - BIESSE	D419 52	D419 252	125	45	30	2 DKN					AS1	1	3 + 3	18	15000
IMA - BIESSE	D419 53	D419 253	125	45	30	2 DKN					AS1	1	4 + 4	24	15000
HOMAG - BIESSE	D419 54	D419 254	125	45	30	2 DKN	6				AS1	7	3 + 3	18	15000
HOMAG - BIESSE	D419 55	D419 255	125	45	30	2 DKN	6				AS1	7	4 + 4	24	15000
BIESSE	D419 56	D419 256	125	48	30	2 DKN					AS1	1	3 + 3	18	15000
BIESSE	D419 57	D419 257	125	48	30	2 DKN					AS1	1	4 + 4	24	15000
HOMAG	D419 58	D419 258	125	48	30	2 DKN	4		40	4	AS1	2	3 + 3	18	15000
HOMAG	D419 59	D419 259	125	48	30	2 DKN	4		40	4	AS1	2	4 + 4	24	15000
	D419 60	D419 260	125	65	30	2 DKN					AS1	1	3 + 3	24	15000
	D419 61	D419 261	125	65	30	2 DKN					AS1	1	4 + 4	32	15000
BIESSE	D419 62	D419 262	125	65	30	2 DKN	8		49	8	AS1	2	3 + 3	24	15000
BIESSE	D419 63	D419 263	125	65	30	2 DKN	8		49	8	AS1	2	4 + 4	32	15000
BRANDT - IMA - SCM IDM - BIESSE	D419 64	D419 264	125	65	30	2 DKN	25,4		40,6		AS1	7	3 + 3	24	15000
BRANDT - IMA - SCM IDM - BIESSE	D419 65	D419 265	125	65	30	2 DKN	25,4		40,6		AS1	7	4 + 4	32	15000
HOMAG	D419 66	D419 266	125	65	30	2 DKN	12,5		40	12,5	AS1	2	3 + 3	24	15000
HOMAG	D419 67	D419 267	125	65	30	2 DKN	12,5		40	12,5	AS1	2	4 + 4	32	15000
GRIGGIO - HOLZ-HER	D419 68	D419 268	125	65	30	2 DKN	28		25	12	AS1	2	3 + 3	24	15000
GRIGGIO - HOLZ-HER	D419 69	D419 269	125	65	30	2 DKN	28		25	12	AS1	2	4 + 4	32	15000

## DIAMETER 150 ANGLE AXIAL 54,9°

Macchina Machine	Cod. DX / RH	Cod. SX / LH	ø D mm	B mm	ø d mm	DKN	See drawings pag. 123				AS1 S1	Type	Z	Z Tot	rpm max
							A	A1	T	C					
HOMAG	D419 70	D419 270	150	43	30	2 DKN	1,5		40	1,5	AS1	2	3 + 3	18	15000
HOMAG	D419 71	D419 271	150	43	30	2 DKN	1,5		40	1,5	AS1	2	4 + 4	24	15000
HOMAG	D419 72	D419 272	150	65	30	2 DKN	13,75		40	13,75	AS1	2	3 + 3	24	15000
HOMAG	D419 73	D419 273	150	65	30	2 DKN	13,75		40	13,75	AS1	2	4 + 4	32	15000



**S1**  
DISPOSIZIONE SIMMETRICA  
SYMMETRIC TIP ARRANGEMENT



**AS1**  
DISPOSIZIONE ASIMMETRICA  
ASYMMETRIC TIP ARRANGEMENT

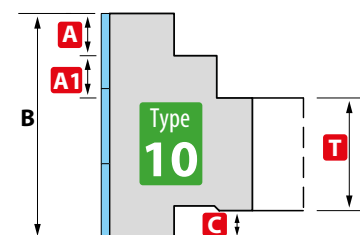
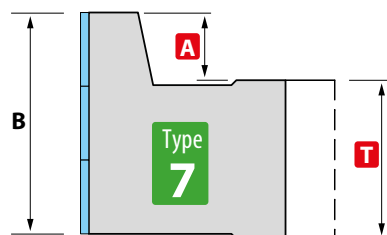
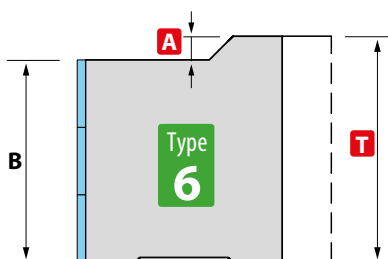
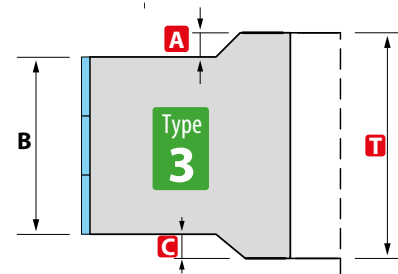
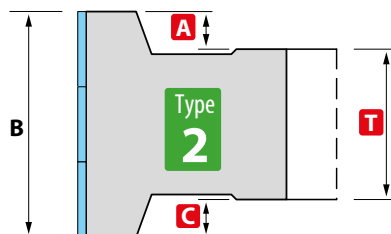
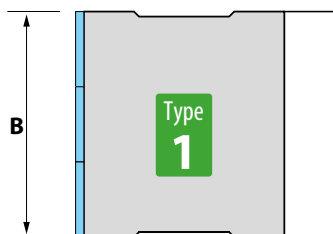



A series of horizontal lines providing a space for handwritten notes.

Section  
**INDEX**

**INDEX**  
by article

Disegni, fotografie e dati tecnici degli utensili presenti in questo catalogo si intendono come indicativi e possono subire modifiche anche senza preavviso. Questo catalogo è di proprietà esclusiva della LEUT Srl, tutti i diritti sono riservati, é vietata qualsiasi riproduzione intera o parziale, salvo autorizzazione scritta.

Drawings, photographs and technical data of the tools in this catalog are intended as indicative and may be subject to change without notice. This catalog is the exclusive property of LEUT Srl, all rights are reserved, any reproduction in whole or in part is prohibited, unless authorized in writing.

Zeichnungen, Fotos und technische Daten der Werkzeuge in diesem Katalog dienen nur als Anhaltspunkt und können ohne Vorankündigung geändert werden. Dieser Katalog ist das ausschließliche Eigentum von LEUT Srl, alle Rechte sind vorbehalten, jegliche Reproduktion, auch auszugsweise, ist untersagt, sofern nicht schriftlich genehmigt.

Los dibujos, fotografías y datos técnicos de las herramientas en este catálogo son indicativos y pueden estar sujetos a cambios sin previo aviso. Este catálogo es propiedad exclusiva de LEUT Srl, todos los derechos están reservados, cualquier reproducción total o parcial está prohibida, a menos que esté autorizada por escrito.

Les dessins, photographies et données techniques des outils de ce catalogue sont donnés à titre indicatif et peuvent faire l'objet de modifications sans préavis. Ce catalogue est la propriété exclusive de LEUT Srl, tous droits réservés, toute reproduction totale ou partielle est interdite, sauf autorisation écrite.

Чертежи, фотографии и технические данные инструментов в этом каталоге предназначены как ориентировочные и могут быть изменены без предварительного уведомления. Этот каталог является исключительной собственностью LEUT Srl, все права защищены, любое воспроизведение полностью или частично запрещено, если только это не разрешено в письменной форме.

Section  
**INDEX**

**INDEX**  
by article



[www.leut.it](http://www.leut.it)



Via Pisano, 1 - 37053 - Asparetto di CERA - Verona ITALY

Tel. +39 0442 83244 | Fax +39 0442 83283

info@leut.it | Skype: leut srl

[www.leut.it](http://www.leut.it)



Art.			pag.
<b>Art. D7A</b>	confezione di 5 punte in diamante Z2 con corpo in acciaio DP H 4,5 mm	<i>Kit comprising DP diamond tools, H4.5mm</i>	21
<b>Art. D7B</b>	confezione di 5 punte in diamante Z2 con corpo in acciaio DP H 4,5 mm	<i>Kit comprising DP diamond tools, H4.5mm</i>	21
<b>Art. D7C</b>	confezione di 5 punte in diamante Z2 con corpo in acciaio DP H4,5 mm	<i>Kit comprising DP diamond tools, H4.5mm</i>	21
<b>Art. D7D</b>	confezione di 4 punte in diamante Z2 con corpo in acciaio DP H 4,5 mm	<i>Kit comprising DP diamond tools, H4.5mm</i>	22
<b>Art. D11A</b>	confezione di 5 punte in diamante Z2 con corpo in acciaio DP H 4,5 mm	<i>Kit comprising DP diamond tools, H4.5mm</i>	22
<b>Art. D11B</b>	confezione di 5 punte in diamante Z2 con corpo in acciaio DP H 4,5 mm	<i>Kit comprising DP diamond tools, H4.5mm</i>	22
<b>Art. D11C</b>	confezione di 5 punte in diamante Z2 con corpo in acciaio DP H 4,5 mm	<i>Kit comprising DP diamond tools, H4.5mm</i>	22
<b>Art. D11D</b>	confezione di 4 punte in diamante Z2 con corpo in acciaio DP H 4,5 mm	<i>Kit comprising DP diamond tools, H4.5mm</i>	22
<b>Art. D101</b>	lama in diamante DP H 4 mm	<i>DP diamond blade, H 4 mm</i>	7
<b>Art. D102</b>	lama in diamante DP H 6 mm	<i>DP diamond blade, H 6 mm</i>	7
<b>Art. D103</b>	lama in diamante per sezionatrici DP H 4 mm	<i>Low noise DP diamond blade, H4mm, for panel sizing saws</i>	7
<b>Art. D104</b>	lama in diamante per sezionatrici DP H 6 mm	<i>Low noise DP diamond blade, H6 mm, for panel sizing saws</i>	7
<b>Art. D105</b>	Lama incisore conico in diamante DP H4mm	<i>DP diamond conical scoring blade, H4mm</i>	8
<b>Art. D106</b>	Lama incisore conico in diamante DP H6 mm	<i>DP diamond conical scoring blade, H6mm</i>	9
<b>Art. D107</b>	Lama incisore in diamante regolabile DP H4 mm	<i>Adjustable DP diamond scoring blade, H4mm</i>	10
<b>Art. D108</b>	Lama incisore in diamante regolabile DP H6 mm	<i>Adjustable DP diamond scoring blade, H6mm</i>	10
<b>Art. D109</b>	fresa in diamante per giunzioni lamello Clamex P-System corpo in acciaio DP H 3,5 mm	<i>DP diamond cutter for Lamello Clamex P-system connectors, steel body, H 3.5 mm</i>	18
<b>Art. D110</b>	lama in diamante per materiali duri e abrasivi DP H 4 mm	<i>DP diamond blade for hard and abrasive materials, H 4 mm</i>	10
<b>Art. D111</b>	lama in diamante corpo in acciaio speciale, affilabile 2 volte	<i>diamond blade, special steel body, sharpenable 2 times</i>	10
<b>Art. D201</b>	fresa in diamante con tagliente dritto Z1 con corpo HW DP H 3,5 mm	<i>DP diamond router bit with straight cut Z1, HW body, H 3.5 mm</i>	13
<b>Art. D203</b>	fresa in diamante con tagliente negativo Z1 con corpo HW DP H 3,5 mm	<i>DP diamond router bit with negative cut Z1, HW body, H 3.5 mm</i>	13
<b>Art. D204</b>	fresa in diamante con tagliente dritto Z2 con corpo HW DP H 3,5 mm	<i>DP diamond router bit with straight cut Z2, HW body, H 3.5 mm</i>	13
<b>Art. D206</b>	fresa in diamante con tagliente negativo Z2 con corpo HW DP H 3,5 mm	<i>DP diamond router bit with negative cut Z2, HW body, H 3.5 mm</i>	13
<b>Art. D212</b>	fresa in diamante elicoidale Z1+1 con corpo in acciaio DP H 2,5 mm	<i>DP diamond helical router bit Z1+1, steel body, H 2.5 mm</i>	13
<b>Art. D213</b>	fresa in diamante elicoidale Z1+1 con corpo in acciaio DP H 4,5 mm	<i>DP diamond helical router bit Z1+1, steel body, H 4.5 mm</i>	13
<b>Art. D214</b>	fresa in diamante elicoidale con cuscinetto Z1+1 con corpo in acciaio DP H 2,5 mm	<i>DP diamond helical router bit Z1+1 with copy bearing, steel body, H 2.5 mm</i>	14
<b>Art. D215</b>	fresa in diamante elicoidale Z2+2 con corpo in acciaio DP H 2,5 mm	<i>DP diamond helical router bit Z2+2, steel body, H 2.5 mm</i>	14
<b>Art. D216</b>	fresa in diamante elicoidale Z2+2 con corpo in acciaio DP H 4,5 mm	<i>DP diamond helical router bit Z2+2, steel body, H 4.5 mm</i>	14
<b>Art. D220</b>	fresa indiamante elicoidale Z2+2 con corpo in acciaio DP H 2,5 mm	<i>DP diamond helical router bit Z2+2, steel body, H 2.5 mm</i>	14
<b>Art. D221</b>	fresa in diamante elicoidale Z2+2 con corpo in acciaio DP H 2,5 mm	<i>DP diamond helical router bit Z2+2, steel body, H 2.5 mm</i>	14

Art.			pag.
<b>Art. D224</b>	fresa in diamante elicoidale Z3+3 con corpo in acciaio DP H 4,5 mm	<i>DP diamond helical router bit Z3+3, steel body, H 4.5 mm</i>	<b>14</b>
<b>Art. D225</b>	fresa in diamante elicoidale Z3+3 con corpo in acciaio DP H 4,5 mm	<i>DP diamond helical router bit Z3+3, steel body, H 4.5 mm</i>	<b>15</b>
<b>Art. D228</b>	fresa in diamante elicoidale Z2+2 con corpo in acciaio DP H 4,5 mm	<i>DP diamond helical router bit Z2+2, steel body, H 4.5 mm</i>	<b>15</b>
<b>Art. D229</b>	fresa in diamante elicoidale Z2+2 con corpo in acciaio DP H 4,5 mm	<i>DP diamond helical router bit Z2+2, steel body, H 4.5 mm</i>	<b>15</b>
<b>Art. D230</b>	fresa in diamante elicoidale Z3+3 con corpo in acciaio DP H 4,5 mm	<i>DP diamond helical router bit Z3+3, steel body, H 4.5 mm</i>	<b>15</b>
<b>Art. D232</b>	fresa in diamante elicoidale simmetrica Z2+2 con corpo in acciaio DP H 4,5 mm	<i>DP diamond helical router bit Z2+2, SYMMETRICAL, steel body, H 4.5 mm</i>	<b>15</b>
<b>Art. D233</b>	fresa in diamante elicoidale Z2+2 con corpo in acciaio DP H 4,5 mm	<i>DP diamond helical router bit Z2+2, steel body, H 4.5 mm</i>	<b>15</b>
<b>Art. D234</b>	fresa in diamante elicoidale Z2+2 con corpo in acciaio DP H 4,5 mm	<i>DP diamond helical router bit Z2+2, steel body, H 4.5 mm</i>	<b>16</b>
<b>Art. D236</b>	fresa in diamante elicoidale Z2+2 con corpo in acciaio DP H 4,5 mm	<i>DP diamond helical router bit Z2+2, steel body, H 4.5 mm</i>	<b>16</b>
<b>Art. D239</b>	fresa in diamante con tagliente positivo negativo Z4 rompitruciolo con corpo in HDM metallo pesante DP H 3,5 mm	<i>DP diamond router bit with positive+negative cut Z4, chip-breaker, high density metal body, H 3.5 mm</i>	<b>13</b>
<b>Art. D240</b>	fresa in diamante elicoidale Z2+2 con corpo in HDM metallo pesante DP H 3,5 mm	<i>DP diamond helical router bit Z2+2, high density metal body, H 3.5 mm</i>	<b>16</b>
<b>Art. D241</b>	fresa in diamante elicoidale Z3+3 con corpo in HDM metallo pesante DP H 3,5 mm	<i>DP diamond helical router bit Z3+3, high density metal body, H 3.5 mm</i>	<b>16</b>
<b>Art. D242</b>	fresa in diamante elicoidale Z3+3 con corpo in HDM metallo pesante DP H 3,5 mm	<i>DP diamond helical router bit Z3+3, HDM heavy metal body, H 3.5 mm</i>	<b>17</b>
<b>Art. D243</b>	fresa in diamante elicoidale Z3+3 con corpo in HDM metallo pesante DP H 3,5 mm	<i>DP diamond helical router bit Z3+3, high density metal body, H 3.5 mm</i>	<b>16</b>
<b>Art. D245</b>	fresa in diamante elicoidale Z1+1 con corpo HW DP H 2,5 mm	<i>DP diamond helical router bit Z1+1, HW body, H 2.5 mm</i>	<b>13</b>
<b>Art. D246</b>	fresa in diamante con tagliente positivo negativo Z2 con corpo HW DP H 3,5 mm	<i>DP diamond router bit with positive+negative cut Z2, HW body, H 3.5 mm</i>	<b>13</b>
<b>Art. D248</b>	fresa in diamante elicoidale Z2+2 con corpo in acciaio DP H 4,5 mm	<i>DP diamond helical router bit Z2+2, steel body, H 4.5 mm</i>	<b>17</b>
<b>Art. D249</b>	fresa in diamante elicoidale Z3+3 con corpo in acciaio DP H 4,5 mm	<i>DP diamond helical router bit Z3+3, steel body, H 4.5 mm</i>	<b>17</b>
<b>Art. D250</b>	fresa in diamante elicoidale da rettifica Z4+4 con corpo in acciaio DP H 4,5 mm	<i>DP diamond helical router bit Z4+4 for finishing, steel body H 4.5 mm</i>	<b>24</b>
<b>Art. D251</b>	fresa in diamante da rettifica su HSK63F Z4+4 DP H 4,5 mm	<i>DP diamond router bit Z4+4 for finishing, HSK63F shank, H 4.5 mm</i>	<b>24</b>
<b>Art. D252</b>	fresa in diamante Z2+2 per serrature porte con corpo in HDM metallo pesante DP H 3,5 mm	<i>DP diamond cutter Z2+2 for door locks with high density metal body, H 3.5 mm</i>	<b>17</b>
<b>Art. D253</b>	fresa in diamante da rettifica su HSK63F Z3+3 DP H 4,5 mm	<i>DP diamond router bit Z3+3 for finishing, HSK63F shank, H 4.5 mm</i>	<b>24</b>
<b>Art. D255</b>	fresa in diamante elicoidale da rettifica Z3+3 con corpo in acciaio DP H 4,5 mm	<i>DP diamond helical router bit Z3+3 for finishing, steel body, H 4.5 mm</i>	<b>24</b>
<b>Art. D256</b>	fresa in diamante per spianare Z3 / Z4 / Z6 con corpo in acciaio DP H 4,5 mm	<i>diamond router bit for planing Z3 / Z4 / Z6, steel body, H 4.5 mm</i>	<b>17</b>
<b>Art. D259</b>	fresa in diamante elicoidale Z2+2 con corpo in HDM metallo pesante DP H 3,5 mm	<i>DP diamond helical router bit Z2+2, high density metal body, H 3.5 mm</i>	<b>16</b>
<b>Art. D260</b>	fresa in diamante elicoidale da rettifica Z3+3 con corpo in acciaio DP H 4,5 mm	<i>DP diamond radius router bit Z3+3 for nesting, steel body H 4.5 mm</i>	<b>24</b>
<b>Art. D261</b>	Fresa in diamante per nesting con raggio DP H3.5mm	<i>DP diamond radius cutter for nesting, H3.5mm</i>	<b>21</b>
<b>Art. D265</b>	fresa in diamante elicoidale da rettifica Z3+3 con corpo in acciaio DP H 4,5 mm	<i>DP diamond helical router bit Z3+3 for contouring, steel body, H 4.5 mm</i>	<b>24</b>
<b>Art. D275</b>	Fresa in diamante per folding a 45° DP H4.5mm	<i>DP diamond cutter for 45° folding, H4.5mm</i>	<b>21</b>

Art.			pag.
<b>Art. D276</b>	Fresa in diamante per folding DP H4mm	<i>DP diamond cutter for folding, H4mm</i>	<b>21</b>
<b>Art. D307</b>	Testa in diamante antisceggia per bordatrice con coltelli a gettare DP H3mm, assialità 45°	<i>DP diamond anti-splinter head with reversible knives for edgebander, H3mm, 45° axial angle</i>	<b>27</b>
<b>Art. D308</b>	fresa in diamante T-SLOT per profili in alluminio Z2+2 corpo in acciaio DP H 4,5 mm	<i>DP diamond T-SLOT router bit Z2+2 for aluminium profiles, steel body H 4.5 mm</i>	<b>21</b>
<b>Art. D309</b>	fresa in diamante per giunzioni lamello Clamex P-System Z1 corpo in HDM metallo pesante DP H 3 mm	<i>DP diamond cutter Z1 for Lamello Clamex P-system connectors, high density metal body, H 3</i>	<b>17</b>
<b>Art. D310</b>	Testa antisceggia in diamante con coltelli a gettare DP H3mm, su HSK63F, assialità 45°	<i>DP diamond anti-splinter head with reversible knives, H3mm, on HSK63F, 45° axial angle</i>	<b>24</b>
<b>Art. D351</b>	fresa HW integrale per giunzioni lamello Clamex P-System Z2	<i>full HW router bit Z2 for Lamello Clamex P-system connectors</i>	<b>17</b>
<b>Art. D401</b>	Fresa in diamante antisceggia per bordatrice DP H2.5mm angoli assiali 20°/30°	<i>Anti-splinter DP diamond cutter for edgebander, H2.5mm, 20°/30° axial angles</i>	<b>28</b>
<b>Art. D402</b>	Fresa in diamante antisceggia per bordatrice DP H2.5mm, angoli assiali 20°/30°	<i>Anti-splinter DP diamond cutter for edgebander, H2.5mm, 20°/30° axial angles</i>	<b>30</b>
<b>Art. D403</b>	Fresa in diamante antisceggia per bordatrice DP H4.5mm, angoli assiali 20°/30°	<i>Anti-splinter DP diamond cutter for edgebander, H2.5mm, 20°/30° axial angles</i>	<b>29</b>
<b>Art. D404</b>	Fresa in diamante antisceggia per bordatrice DP H4.5mm angoli assiali 20°/30°	<i>Anti-splinter DP diamond cutter for edgebander, H4.5mm, 20°/30° axial angles</i>	<b>32</b>
<b>Art. D413</b>	Fresa in diamante antisceggia per bordatrice DP H4.5mm con angoli assiali 45°	<i>Anti-splinter DP diamond cutter for edgebander, H4.5mm, with 45° axial angles</i>	<b>33</b>
<b>Art. D419</b>	Fresa in diamante antisceggia per bordatrice DP H4.5mm con angoli assiali 54,9°	<i>Anti-splinter DP diamond cutter for edgebander, H4.5mm, with 54.9° axial angles</i>	<b>34</b>
<b>Art. D429</b>	Frese in diamante per bordatrice DP H2.5mm / 4.5mm	<i>DP diamond cutters for edgebander, H2.5mm/4.5mm</i>	<b>26</b>
<b>Art. D435</b>	Fresa per incastri regolabile in diamante DP H4.5mm	<i>Adjustable DP diamond cutter for grooves, H4.5mm</i>	<b>11</b>
<b>Art. D437</b>	Frese in diamante per bordatrice DP H2.5mm / 4.5mm	<i>DP diamond cutters for edgebander, H2.5mm/4.5mm</i>	<b>26</b>
<b>Art. D490</b>	Frese per incastri in diamante DP H4.5mm	<i>DP diamond cutters for grooves, H4.5mm</i>	<b>10</b>
<b>Art. D501</b>	Frese in diamante per bordatrici inclinate DP H3mm	<i>Inclined DP diamond cutters for edgebanders, H3mm</i>	<b>26</b>
<b>Art. D502</b>	Frese in diamante per bordatrici inclinate DP H3mm	<i>Inclined DP diamond cutters for edgebanders, H3mm</i>	<b>26</b>
<b>Art. D503</b>	Frese in diamante per bordatrici raggiate DP H3mm	<i>DP diamond radius cutters for edgebanders, H3mm</i>	<b>27</b>
<b>Art. D504</b>	Frese in diamante per bordatrici raggiate DP H3mm	<i>DP diamond radius cutters for edgebanders, H3mm</i>	<b>26</b>
<b>Art. D505</b>	Frese in diamante per bordatrici raggiate DP H3mm	<i>DP diamond radius cutters for edgebanders, H3mm</i>	<b>27</b>
<b>Art. D701</b>	punta in diamante foratrice per fori passanti Z1 corpo in acciaio	<i>diamond drill bit Z1 for through holes, steel body</i>	<b>18</b>
<b>Art. D702</b>	punta in diamante foratrice per fori passanti Z2 corpo in HW	<i>diamond drill bit Z2 for through holes, HW body</i>	<b>18</b>
<b>Art. D703</b>	punta in diamante foratrice per fori ciechi Z2 corpo in HW	<i>diamond drill bit Z2 for blind holes, HW body</i>	<b>18</b>
<b>Art. D704</b>	punta in diamante foratrice per fori passanti Z2+2 corpo in acciaio	<i>diamond drill bit Z2+2 for through holes, steel body</i>	<b>19</b>
<b>Art. D705</b>	punta in diamante foratrice per fori ciechi Z2+2 con rompitruciolo corpo in acciaio	<i>diamond drill bit Z2+2 for blind holes, with chip-breaker, steel body</i>	<b>18</b>
<b>Art. D820</b>	ghiera turbo con turbina per estrazione trucioli	<i>turbo ring for chip removal</i>	<b>17</b>
<b>Art. D833</b>	albero portalama con attacco cilindrico	<i>blade holder with cylindrical shank</i>	<b>18</b>
<b>Art. D836</b>	chiave a settore din 1810 per ghiera turbo 820	<i>DIN 1810 c-spanner for turbo ring 820</i>	<b>17</b>



## **LAME IN DIAMANTE**

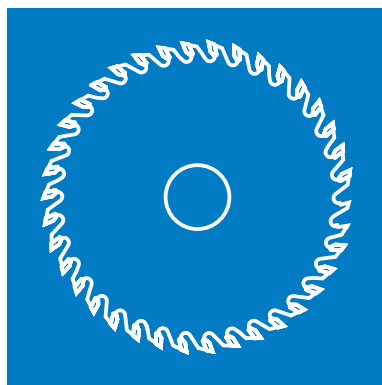

**DIAMOND SAW BLADES**

**DIAMANTKREISSÄGEBLATT**

**HOJAS CIRCULARES EN DIAMANTE**

**LAMES EN DIAMANT**

**АЛМАЗНЫЕ ПИЛЫ**

Art. D101



pag. 11

Cod.	€	pag.
D101 10	774,00	11
D101 11	852,00	11
D101 12	1.120,00	11
D101 13	696,00	11
D101 14	852,00	11
D101 15	1.000,00	11
D101 16	1.320,00	11
D101 17	1.206,00	11
D101 18	1.526,00	11

Art. D102



pag. 11

Cod.	€	pag.
D102 10	885,00	11
D102 11	976,00	11
D102 12	1.275,00	11
D102 13	796,00	11
D102 14	976,00	11
D102 15	1.155,00	11
D102 16	1.515,00	11
D102 17	1.392,00	11
D102 18	1.765,00	11

Art. D103



pag. 12

Cod.	€	pag.
D103 10	986,00	12
D103 11	986,00	12
D103 12	986,00	12
D103 13	986,00	12
D103 14	1.165,00	12

D103 15	1.165,00	12
D103 16	1.165,00	12
D103 17	1.165,00	12
D103 18	986,00	12
D103 19	1.165,00	12
D103 20	1.165,00	12
D103 21	927,00	12
D103 22	927,00	12
D103 23	1.196,00	12
D103 24	1.196,00	12
D103 25	1.196,00	12
D103 26	1.196,00	12
D103 27	927,00	12
D103 28	927,00	12
D103 29	927,00	12
D103 30	1.196,00	12
D103 31	1.196,00	12
D103 32	1.196,00	12
D103 33	1.017,00	12
D103 34	1.196,00	12
D103 35	838,00	12
D103 36	838,00	12
D103 37	1.017,00	12
D103 38	1.017,00	12
D103 39	1.196,00	12
D103 40	1.196,00	12
D103 41	1.196,00	12
D103 42	1.196,00	12
D103 43	1.045,00	12
D103 44	1.229,00	12
D103 45	1.414,00	12
D103 46	868,00	12
D103 47	868,00	12
D103 48	868,00	12
D103 49	868,00	12
D103 50	1.047,00	12
D103 51	1.047,00	12
D103 52	1.047,00	12
D103 53	1.047,00	12
D103 54	1.226,00	12
D103 55	1.226,00	12
D103 56	1.226,00	12
D103 57	1.226,00	12
D103 58	1.260,00	12
D103 59	1.075,00	12
D103 60	1.444,00	12
D103 61	898,00	12
D103 62	898,00	12
D103 63	898,00	12
D103 64	1.077,00	12
D103 65	1.077,00	12
D103 66	1.077,00	12
D103 67	1.256,00	12
D103 68	1.256,00	12
D103 69	1.256,00	12
D103 70	1.614,00	12
D103 71	914,00	12
D103 72	914,00	12
D103 73	914,00	12
D103 74	1.093,00	12
D103 75	1.093,00	12
D103 76	1.093,00	12
D103 77	1.272,00	12
D103 78	1.272,00	12
D103 79	1.272,00	12
D103 80	936,00	12
D103 81	936,00	12
D103 82	936,00	12
D103 83	1.121,00	12
D103 84	1.121,00	12
D103 85	1.121,00	12
D103 86	1.305,00	12
D103 87	1.305,00	12
D103 88	1.305,00	12
D103 89	1.272,00	12
D103 90	914,00	12
D103 91	1.093,00	12
D103 92	1.272,00	12
D103 93	1.630,00	12
D103 94	951,00	12
D103 95	1.136,00	12
D103 96	1.321,00	12
D103 97	1.321,00	12
D103 98	929,00	12
D103 99	929,00	12
D103 100	1.108,00	12
D103 101	1.108,00	12
D103 102	1.287,00	12
D103 103	951,00	12
D103 104	951,00	12
D103 105	951,00	12
D103 106	1.136,00	12
D103 107	1.136,00	12
D103 108	1.321,00	12
D103 109	1.321,00	12
D103 110	951,00	12
D103 111	1.136,00	12
D103 112	1.321,00	12

Art. D104



pag. 14

Cod.	€	pag.
D104 10	1.109,00	14
D104 11	1.109,00	14
D104 12	1.109,00	14
D104 13	1.109,00	14
D104 14	1.313,00	14
D104 15	1.313,00	14
D104 16	1.313,00	14
D104 17	1.313,00	14
D104 18	1.109,00	14
D104 19	1.313,00	14
D104 20	1.313,00	14
D104 21	1.038,00	14
D104 22	1.038,00	14
D104 23	1.343,00	14
D104 24	1.343,00	14
D104 25	1.343,00	14
D104 26	1.343,00	14
D104 27	1.038,00	14
D104 28	1.038,00	14

D104 29	1.038,00	14
D104 30	1.343,00	14
D104 31	1.343,00	14
D104 32	1.343,00	14
D104 33	1.139,00	14
D104 34	1.343,00	14
D104 35	936,00	14
D104 36	936,00	14
D104 37	1.139,00	14
D104 38	1.139,00	14
D104 39	1.343,00	14
D104 40	1.343,00	14
D104 41	1.343,00	14
D104 42	1.343,00	14
D104 43	1.179,00	14
D104 44	1.390,00	14
D104 45	1.602,00	14
D104 46	966,00	14
D104 47	966,00	14
D104 48	966,00	14
D104 49	966,00	14
D104 50	1.170,00	14
D104 51	1.170,00	14
D104 52	1.170,00	14
D104 53	1.170,00	14
D104 54	1.373,00	14
D104 55	1.373,00	14
D104 56	1.373,00	14
D104 57	1.373,00	14
D104 58	1.421,00	14
D104 59	1.209,00	14
D104 60	1.632,00	14
D104 61	997,00	14
D104 62	997,00	14
D104 63	997,00	14
D104 64	1.200,00	14
D104 65	1.200,00	14
D104 66	1.200,00	14
D104 67	1.404,00	14
D104 68	1.404,00	14
D104 69	1.404,00	14
D104 70	1.811,00	14
D104 71	1.012,00	14
D104 72	1.012,00	14
D104 73	1.012,00	14
D104 74	1.215,00	14
D104 75	1.215,00	14
D104 76	1.215,00	14
D104 77	1.419,00	14
D104 78	1.419,00	14
D104 79	1.419,00	14
D104 80	1.043,00	14
D104 81	1.043,00	14
D104 82	1.043,00	14
D104 83	1.255,00	14
D104 84	1.255,00	14
D104 85	1.255,00	14
D104 86	1.466,00	14
D104 87	1.466,00	14
D104 88	1.466,00	14
D104 89	1.419,00	14
D104 90	1.012,00	14
D104 91	1.215,00	14
D104 92	1.419,00	14
D104 93	1.826,00	14
D104 94	1.059,00	14

D104 95	1.270,00	14
D104 96	1.482,00	14
D104 97	1.482,00	14
D104 98	1.027,00	14
D104 99	1.027,00	14
D104 100	1.231,00	14
D104 101	1.231,00	14
D104 102	1.434,00	14
D104 103	1.059,00	14
D104 104	1.059,00	14
D104 105	1.059,00	14
D104 106	1.270,00	14
D104 107	1.270,00	14
D104 108	1.482,00	14
D104 109	1.482,00	14
D104 110	1.059,00	14
D104 111	1.270,00	14
D104 112	1.482,00	14

**Art. D105**



pag.  
16

Cod.	€	pag.
<b>Tipo/Type 1</b>		
D105 10	268,00	16
D105 11	268,00	16
D105 12	460,00	16
D105 13	460,00	16
D105 14	460,00	16
D105 15	460,00	16
D105 16	460,00	16
D105 17	460,00	16
D105 18	460,00	16
D105 19	460,00	16
D105 20	460,00	16
D105 21	460,00	16
D105 22	460,00	16
D105 23	460,00	16
D105 24	460,00	16
D105 25	460,00	16
D105 26	460,00	16
D105 27	460,00	16
D105 28	460,00	16
D105 29	460,00	16
D105 30	460,00	16
D105 31	524,00	16
D105 32	460,00	16
D105 33	524,00	16
D105 34	460,00	16
D105 35	651,00	16
D105 36	651,00	16
D105 37	651,00	16
D105 38	651,00	16
D105 39	651,00	16
D105 40	651,00	16
D105 41	651,00	16

D105 42	651,00	16
D105 43	651,00	16
D105 44	651,00	16
D105 45	651,00	16
D105 46	651,00	16
D105 47	651,00	16
D105 48	651,00	16
D105 49	651,00	16
D105 50	747,00	16
D105 51	651,00	16
D105 52	524,00	16
D105 53	524,00	16
D105 54	651,00	16
D105 55	651,00	16
D105 56	651,00	16
D105 57	651,00	16
D105 58	651,00	16
D105 59	651,00	16
D105 60	651,00	16
D105 61	651,00	16
D105 62	651,00	16
D105 63	651,00	16
D105 64	651,00	16
D105 65	651,00	16
D105 66	651,00	16
D105 67	651,00	16
D105 68	651,00	16
D105 69	651,00	16
D105 70	651,00	16
D105 71	651,00	16
D105 72	651,00	16
D105 73	651,00	16
D105 74	651,00	16
D105 75	651,00	16
D105 76	651,00	16
D105 77	651,00	16
D105 78	651,00	16
D105 79	651,00	16
D105 80	756,00	16
D105 81	756,00	16
D105 82	660,00	16
D105 83	852,00	16
D105 84	1.236,00	16
D105 85	1.236,00	16
D105 86	852,00	16
D105 87	852,00	16
D105 88	852,00	16
D105 89	1.236,00	16
<b>Tipo/Type 2</b>		
D105 110	268,00	16
D105 111	268,00	16
D105 112	460,00	16
D105 113	460,00	16
D105 114	460,00	16
D105 115	460,00	16
D105 116	460,00	16
D105 117	460,00	16
D105 118	460,00	16
D105 119	460,00	16
D105 120	460,00	16
D105 121	460,00	16
D105 122	460,00	16
D105 123	460,00	16
D105 124	460,00	16
D105 125	460,00	16
D105 126	460,00	16

D105 127	460,00	16
D105 128	460,00	16
D105 129	460,00	16
D105 130	460,00	16
D105 131	524,00	16
D105 132	460,00	16
D105 133	524,00	16
D105 134	460,00	16
D105 135	651,00	16
D105 136	651,00	16
D105 137	651,00	16
D105 138	651,00	16
D105 139	651,00	16
D105 140	651,00	16
D105 141	651,00	16
D105 142	651,00	16
D105 143	651,00	16
D105 144	651,00	16
D105 145	651,00	16
D105 146	651,00	16
D105 147	651,00	16
D105 148	651,00	16
D105 149	651,00	16
D105 150	747,00	16
D105 151	651,00	16
D105 152	524,00	16
D105 153	524,00	16
D105 154	651,00	16
D105 155	651,00	16
D105 156	651,00	16
D105 157	651,00	16
D105 158	651,00	16
D105 159	651,00	16
D105 160	651,00	16
D105 161	651,00	16
D105 162	651,00	16
D105 163	651,00	16
D105 164	651,00	16
D105 165	651,00	16
D105 166	651,00	16
D105 167	651,00	16
D105 168	651,00	16
D105 169	651,00	16
D105 170	651,00	16
D105 171	651,00	16
D105 172	651,00	16
D105 173	651,00	16
D105 174	651,00	16
D105 175	651,00	16
D105 176	651,00	16
D105 177	651,00	16
D105 178	651,00	16
D105 179	651,00	16
D105 180	756,00	16
D105 181	756,00	16
D105 182	660,00	16
D105 183	852,00	16
D105 184	1.236,00	16
D105 185	1.236,00	16
D105 186	852,00	16
D105 187	852,00	16
D105 188	852,00	16
D105 189	1.236,00	16

Art. D106



pag. 18

Cod.	€	pag.
<b>Tipo/Type 1</b>		
D106 10	297,00	18
D106 11	297,00	18
D106 12	519,00	18
D106 13	519,00	18
D106 14	519,00	18
D106 15	519,00	18
D106 16	519,00	18
D106 17	519,00	18
D106 18	519,00	18
D106 19	519,00	18
D106 20	519,00	18
D106 21	519,00	18
D106 22	519,00	18
D106 23	519,00	18
D106 24	519,00	18
D106 25	519,00	18
D106 26	519,00	18
D106 27	519,00	18
D106 28	519,00	18
D106 29	519,00	18
D106 30	519,00	18
D106 31	593,00	18
D106 32	519,00	18
D106 33	593,00	18
D106 34	519,00	18
D106 35	740,00	18
D106 36	740,00	18
D106 37	740,00	18
D106 38	740,00	18
D106 39	740,00	18
D106 40	740,00	18
D106 41	740,00	18
D106 42	740,00	18
D106 43	740,00	18
D106 44	740,00	18
D106 45	740,00	18
D106 46	740,00	18
D106 47	740,00	18
D106 48	740,00	18
D106 49	740,00	18
D106 50	851,00	18
D106 51	740,00	18
D106 52	593,00	18
D106 53	593,00	18
D106 54	740,00	18
D106 55	740,00	18
D106 56	740,00	18
D106 57	740,00	18
D106 58	740,00	18
D106 59	740,00	18

D106 60	740,00	18
D106 61	740,00	18
D106 62	740,00	18
D106 63	740,00	18
D106 64	740,00	18
D106 65	740,00	18
D106 66	740,00	18
D106 67	740,00	18
D106 68	740,00	18
D106 69	740,00	18
D106 70	740,00	18
D106 71	740,00	18
D106 72	740,00	18
D106 73	740,00	18
D106 74	740,00	18
D106 75	740,00	18
D106 76	740,00	18
D106 77	740,00	18
D106 78	740,00	18
D106 79	740,00	18
D106 80	860,00	18
D106 81	860,00	18
D106 82	749,00	18
D106 83	971,00	18
D106 84	1.413,00	18
D106 85	1.413,00	18
D106 86	971,00	18
D106 87	971,00	18
D106 88	971,00	18
D106 89	1.413,00	18
<b>Tipo/Type 2</b>		
D106 110	297,00	18
D106 111	297,00	18
D106 112	519,00	18
D106 113	519,00	18
D106 114	519,00	18
D106 115	519,00	18
D106 116	519,00	18
D106 117	519,00	18
D106 118	519,00	18
D106 119	519,00	18
D106 120	519,00	18
D106 121	519,00	18
D106 122	519,00	18
D106 123	519,00	18
D106 124	519,00	18
D106 125	519,00	18
D106 126	519,00	18
D106 127	519,00	18
D106 128	519,00	18
D106 129	519,00	18
D106 130	519,00	18
D106 131	593,00	18
D106 132	519,00	18
D106 133	593,00	18
D106 134	519,00	18
D106 135	740,00	18
D106 136	740,00	18
D106 137	740,00	18
D106 138	740,00	18
D106 139	740,00	18
D106 140	740,00	18
D106 141	740,00	18
D106 142	740,00	18
D106 143	740,00	18
D106 144	740,00	18

D106 145	740,00	18
D106 146	740,00	18
D106 147	740,00	18
D106 148	740,00	18
D106 149	740,00	18
D106 150	851,00	18
D106 151	740,00	18
D106 152	593,00	18
D106 153	593,00	18
D106 154	740,00	18
D106 155	740,00	18
D106 156	740,00	18
D106 157	740,00	18
D106 158	740,00	18
D106 159	740,00	18
D106 160	740,00	18
D106 161	740,00	18
D106 162	740,00	18
D106 163	740,00	18
D106 164	740,00	18
D106 165	740,00	18
D106 166	740,00	18
D106 167	740,00	18
D106 168	740,00	18
D106 169	740,00	18
D106 170	740,00	18
D106 171	740,00	18
D106 172	740,00	18
D106 173	740,00	18
D106 174	740,00	18
D106 175	740,00	18
D106 176	740,00	18
D106 177	740,00	18
D106 178	740,00	18
D106 179	740,00	18
D106 180	860,00	18
D106 181	860,00	18
D106 182	749,00	18
D106 183	971,00	18
D106 184	1.413,00	18
D106 185	1.413,00	18
D106 186	971,00	18
D106 187	971,00	18
D106 188	971,00	18
D106 189	1.413,00	18

**Art. D107**



Cod.	€	pag.
D107 10	300,00	20
D107 11	246,00	20
D107 12	359,00	20
D107 13	417,00	20
D107 14	417,00	20
D107 15	417,00	20

pag. 20

D107 16	417,00	20
D107 17	417,00	20
D107 18	417,00	20
D107 19	417,00	20
D107 20	417,00	20
D107 21	417,00	20

**Art. D108**



pag. 21

Cod.	€	pag.
D108 10	323,00	21
D108 11	259,00	21
D108 12	387,00	21
D108 13	450,00	21
D108 14	450,00	21
D108 15	450,00	21
D108 16	450,00	21
D108 17	450,00	21
D108 18	450,00	21
D108 19	450,00	21
D108 20	450,00	21
D108 21	450,00	21

**Art. D110**



pag. 22

Cod.	€	pag.
D110 10	117,00	22
D110 11	179,00	22
D110 12	210,00	22
D110 13	117,00	22
D110 14	117,00	22
D110 15	117,00	22
D110 16	241,00	22
D110 17	179,00	22
D110 18	272,00	22
D110 19	117,00	22
D110 20	241,00	22
D110 21	304,00	22
D110 22	366,00	22

**Art. D111**



pag. 22

Cod.	€	pag.
D111 10	260,00	22
D111 11	312,00	22
D111 12	390,00	22
D111 13	468,00	22
D111 14	572,00	22

**Art. D490**



pag. 23

Cod.	€	pag.
D490 10	416,00	23
D490 11	416,00	23
D490 12	416,00	23
D490 13	416,00	23
D490 14	416,00	23
D490 15	416,00	23
D490 16	416,00	23
D490 17	416,00	23
D490 18	416,00	23
D490 19	416,00	23
D490 20	416,00	23
D490 21	416,00	23
D490 22	416,00	23
D490 23	416,00	23
D490 24	416,00	23
D490 25	416,00	23
D490 26	416,00	23
D490 27	416,00	23
D490 28	416,00	23
D490 29	416,00	23
D490 30	416,00	23
D490 31	416,00	23
D490 32	416,00	23
D490 33	416,00	23
D490 34	416,00	23
D490 35	416,00	23
D490 36	416,00	23
D490 37	416,00	23
D490 38	416,00	23
D490 39	416,00	23
D490 40	416,00	23
D490 41	416,00	23



D490 42	442,00	23
D490 43	442,00	23
D490 44	442,00	23
D490 45	442,00	23
D490 46	442,00	23
D490 47	442,00	23
D490 48	442,00	23
D490 49	442,00	23
D490 50	442,00	23
D490 51	442,00	23
D490 52	442,00	23
D490 53	442,00	23
D490 54	442,00	23
D490 55	442,00	23
D490 56	442,00	23
D490 57	442,00	23
D490 58	442,00	23
D490 59	442,00	23
D490 60	442,00	23
D490 61	442,00	23
D490 62	442,00	23
D490 63	442,00	23
D490 64	442,00	23
D490 65	442,00	23
D490 66	442,00	23
D490 67	442,00	23
D490 68	442,00	23
D490 69	442,00	23
D490 70	442,00	23
D490 71	442,00	23
D490 72	442,00	23
D490 73	442,00	23

**Art. D435**pag.  
24

Cod.	€	pag.
D435 10	549,00	24
D435 11	549,00	24
D435 12	580,00	24
D435 13	580,00	24
D435 14	620,00	24
D435 15	620,00	24
D435 16	650,00	24
D435 17	650,00	24
D435 18	620,00	24
D435 19	620,00	24
D435 20	790,00	24
D435 21	790,00	24
D435 22	760,00	24
D435 23	760,00	24
D435 24	790,00	24
D435 25	790,00	24
D435 26	930,00	24
D435 27	930,00	24
D435 28	975,00	24
D435 29	975,00	24

**FRESE IN DIAMANTE PER FORARE E CONTORNARE  
PUNTE IN DIAMANTE PER FORARE**

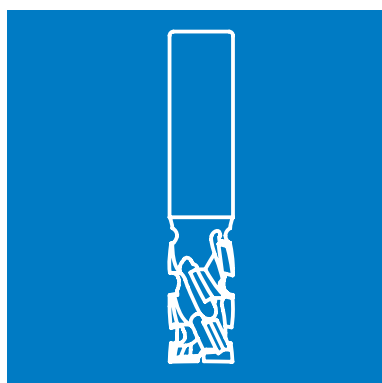

**DIAMOND TOOLS FOR BORING AND CONTOURING  
DIAMOND ROUTERS FOR BORING**

**DIAMANTFRÄSER LÖCHER BOHREN UND FÜGEN  
DIAMANTBOHRER LÖCHER BOHREN**

**FRESAS EN DIAMANTE PARA TALADRAR Y CONTORNEA  
Ù BROCA EN DIAMANTE PARA TALADRAR**

**FRAISES EN DIAMANT POUR PERCER ET CONTOURNER  
MECHES EN DIAMANT POUR PERCER**

**ФРЕЗЫ ДЛЯ СВЕРЛЕНИЙ И КОНТУРНОЙ ОБРАБОТК  
АЛМАЗНЫЕ ФРЕЗЫ ДЛЯ СВЕРЛЕНИЙ И**

Art. D201



pag. 29

D204 13	224,00	30
D204 14	238,00	30

Art. D206



pag. 30

D245 16	162,00	31
D245 17	191,00	31
D245 18	235,00	31

Art. D239



pag. 32

Cod.	€	pag.
D201 10	89,00	29
D201 11	89,00	29
D201 12	96,00	29
D201 13	105,00	29
D201 14	141,00	29
D201 15	132,00	29
D201 16	160,00	29
D201 17	169,00	29

Cod.	€	pag.
D206 10	133,00	30
D206 11	153,00	30
D206 12	164,00	30
D206 13	166,00	30
D206 14	208,00	30
D206 15	208,00	30

Cod.	€	pag.
D239 10	538,00	32
D239 11	585,00	32
D239 12	690,00	32
D239 13	656,00	32

Art. D203



pag. 29

Art. D246



pag. 31

Art. D213



pag. 32

Cod.	€	pag.
D203 10	88,00	29
D203 11	95,00	29
D203 12	103,00	29
D203 13	117,00	29
D203 14	138,00	29
D203 15	128,00	29
D203 16	169,00	29

Cod.	€	pag.
D246 10	129,00	31
D246 11	138,00	31
D246 12	147,00	31
D246 13	172,00	31

Cod.	€	pag.
D213 10	84,00	32
D213 11	113,00	32
D213 12	140,00	32
D213 13	169,00	32
D213 14	197,00	32
D213 15	229,00	32

Art. D204



pag. 30

Art. D245



pag. 31

Art. D212



pag. 33

Cod.	€	pag.
D204 10	156,00	30
D204 11	178,00	30
D204 12	187,00	30

Cod.	€	pag.
D245 10	134,00	31
D245 11	162,00	31
D245 12	199,00	31
D245 13	146,00	31
D245 14	175,00	31
D245 15	210,00	31

Cod.	€	pag.
D212 10	64,00	33
D212 11	64,00	33
D212 12	64,00	33
D212 13	85,00	33
D212 14	106,00	33

D212 15	64,00	33
D212 16	64,00	33
D212 17	85,00	33
D212 18	85,00	33
D212 19	106,00	33
D212 20	106,00	33
D212 21	64,00	33
D212 22	85,00	33
D212 23	106,00	33
D212 24	64,00	33
D212 25	85,00	33
D212 26	106,00	33
D212 27	127,00	33
D212 28	148,00	33
D212 29	169,00	33
D212 30	85,00	33
D212 31	106,00	33
D212 32	127,00	33
D212 33	148,00	33
D212 34	190,00	33
D212 35	211,00	33
D212 36	232,00	33
D212 37	253,00	33
D212 38	274,00	33

**Art. D215**



pag. 34

Cod.	€	pag.
D215 10	127,00	34
D215 11	169,00	34
D215 12	127,00	34
D215 13	127,00	34
D215 14	169,00	34
D215 15	169,00	34
D215 16	127,00	34
D215 17	169,00	34
D215 18	210,00	34
D215 19	127,00	34
D215 20	169,00	34
D215 21	210,00	34
D215 22	253,00	34
D215 23	292,00	34
D215 24	333,00	34
D215 25	351,00	34

**Art. D216**



pag. 35

Cod.	€	pag.
D216 10	169,00	35
D216 11	225,00	35
D216 12	281,00	35
D216 13	343,00	35
D216 14	400,00	35
D216 15	458,00	35
D216 16	505,00	35
D216 17	562,00	35
D216 18	674,00	35
D216 19	730,00	35

**Art. D214**



pag. 36

Cod.	€	pag.
D214 10	85,00	36
D214 11	85,00	36
D214 12	113,00	36
D214 13	113,00	36
D214 14	141,00	36
D214 15	87,00	36
D214 16	89,00	36
D214 17	140,00	36

**Art. D220**



pag. 37

Cod.	€	pag.
D220 10	211,00	37

D220 11	211,00	37
D220 12	281,00	37
D220 13	281,00	37
D220 14	211,00	37
D220 15	281,00	37
D220 16	292,00	37
D220 17	333,00	37
D220 18	375,00	37

**Art. D221**



pag. 38

Cod.	€	pag.
D221 10	280,00	38
D221 11	337,00	38
D221 12	429,00	38
D221 13	280,00	38
D221 14	337,00	38
D221 15	429,00	38
D221 16	487,00	38

**Art. D224**



pag. 39

Cod.	€	pag.
D224 10	258,00	39
D224 11	328,00	39
D224 12	258,00	39
D224 13	328,00	39
D224 14	398,00	39
D224 15	539,00	39
D224 16	605,00	39
D224 17	398,00	39
D224 18	539,00	39
D224 19	605,00	39
D224 20	832,00	39
D224 21	328,00	39
D224 22	539,00	39
D224 23	609,00	39
D224 24	679,00	39
D224 25	832,00	39
D224 26	884,00	39

Art. D225



pag. 40

D228 29	478,00	41
D228 30	534,00	41
D228 31	590,00	41
D228 32	646,00	41
D228 33	702,00	41
D228 34	758,00	41
D228 35	870,00	41

D230 15	790,00	43
D230 16	878,00	43
D230 17	966,00	43
D230 18	1.053,00	43
D230 19	1.141,00	43
D230 20	1.229,00	43

Cod.	€	pag.
D225 10	232,00	40
D225 11	309,00	40
D225 12	386,00	40
D225 13	644,00	40
D225 14	386,00	40
D225 15	540,00	40
D225 16	676,00	40
D225 17	754,00	40
D225 18	832,00	40
D225 19	309,00	40
D225 20	540,00	40
D225 21	618,00	40
D225 22	695,00	40
D225 23	832,00	40

Art. D229



pag. 42

Cod.	€	pag.
D229 10	264,00	42
D229 11	322,00	42
D229 12	380,00	42
D229 13	439,00	42
D229 14	498,00	42
D229 15	543,00	42
D229 16	600,00	42
D229 17	715,00	42
D229 18	264,00	42
D229 19	380,00	42
D229 20	498,00	42
D229 21	556,00	42
D229 22	600,00	42
D229 23	715,00	42
D229 24	380,00	42
D229 25	439,00	42
D229 26	498,00	42
D229 27	556,00	42
D229 28	615,00	42
D229 29	673,00	42
D229 30	732,00	42

Art. D232

pag. 44



Cod.	€	pag.
D232 10	440,00	44
D232 11	575,00	44
D232 12	710,00	44
D232 13	780,00	44
D232 14	913,00	44
D232 15	780,00	44
D232 16	913,00	44
D232 17	1.015,00	44

Art. D228



pag. 41

Cod.	€	pag.
D228 10	253,00	41
D228 11	309,00	41
D228 12	365,00	41
D228 13	253,00	41
D228 14	253,00	41
D228 15	309,00	41
D228 16	365,00	41
D228 17	422,00	41
D228 18	478,00	41
D228 19	544,00	41
D228 20	658,00	41
D228 21	253,00	41
D228 22	365,00	41
D228 23	422,00	41
D228 24	478,00	41
D228 25	590,00	41
D228 26	544,00	41
D228 27	658,00	41
D228 28	422,00	41

Art. D230



pag. 43

Cod.	€	pag.
D230 10	351,00	43
D230 11	439,00	43
D230 12	527,00	43
D230 13	615,00	43
D230 14	702,00	43

Art. D233

pag. 45



Cod.	€	pag.
D233 10	309,00	45
D233 11	422,00	45
D233 12	534,00	45
D233 13	658,00	45
D233 14	773,00	45
D233 15	309,00	45
D233 16	422,00	45
D233 17	534,00	45
D233 18	646,00	45
D233 19	773,00	45
D233 20	309,00	45
D233 21	422,00	45
D233 22	534,00	45
D233 23	646,00	45
D233 24	759,00	45
D233 25	871,00	45

**Art. D234**



pag. 46

Cod.	€	pag.
D234 10	205,00	46
D234 11	205,00	46
D234 12	322,00	46
D234 13	322,00	46
D234 14	439,00	46
D234 15	439,00	46
D234 16	556,00	46
D234 17	556,00	46
D234 18	658,00	46
D234 19	658,00	46
D234 20	773,00	46
D234 21	773,00	46
D234 22	205,00	46
D234 23	205,00	46
D234 24	322,00	46
D234 25	322,00	46
D234 26	439,00	46
D234 27	439,00	46
D234 28	556,00	46
D234 29	556,00	46
D234 30	673,00	46
D234 31	673,00	46
D234 32	773,00	46
D234 33	773,00	46
D234 34	205,00	46
D234 35	322,00	46
D234 36	439,00	46
D234 37	556,00	46
D234 38	673,00	46
D234 39	790,00	46
D234 40	907,00	46
D234 41	1.024,00	46

**Art. D236**



pag. 47

Cod.	€	pag.
D236 10	464,00	47
D236 11	548,00	47

D236 12	632,00	47
D236 13	716,00	47
D236 14	800,00	47
D236 15	957,00	47
D236 16	1.054,00	47
D236 17	464,00	47
D236 18	548,00	47
D236 19	632,00	47
D236 20	716,00	47
D236 21	800,00	47
D236 22	957,00	47
D236 23	1.054,00	47
D236 24	464,00	47
D236 25	548,00	47
D236 26	632,00	47
D236 27	716,00	47
D236 28	800,00	47
D236 29	885,00	47
D236 30	969,00	47
D236 31	1.055,00	47
D236 32	1.138,00	47
D236 33	1.207,00	47
D236 34	1.373,00	47

**Art. D240**



pag. 48

Cod.	€	pag.
D240 10	197,00	48
D240 11	260,00	48
D240 12	197,00	48
D240 13	239,00	48
D240 14	260,00	48
D240 15	302,00	48

**Art. D259**



pag. 49

Cod.	€	pag.
D259 10	209,00	49
D259 11	250,00	49
D259 12	260,00	49
D259 13	293,00	49

D259 14	309,00	49
D259 15	351,00	49
D259 16	393,00	49
D259 17	308,00	49
D259 18	351,00	49
D259 19	393,00	49

**Art. D241**



pag. 50

Cod.	€	pag.
D241 10	250,00	50
D241 11	293,00	50
D241 12	314,00	50
D241 13	356,00	50
D241 14	372,00	50
D241 15	415,00	50
D241 16	372,00	50
D241 17	456,00	50
D241 18	540,00	50

**Art. D243**



pag. 51

Cod.	€	pag.
D243 10	272,00	51
D243 11	335,00	51
D243 12	335,00	51
D243 13	398,00	51
D243 14	393,00	51
D243 15	457,00	51
D243 16	520,00	51
D243 17	393,00	51
D243 18	457,00	51
D243 19	520,00	51

**Art. D242**



D249 13	1.367,00	54
D249 14	1.550,00	54
D249 15	1.732,00	54
D249 16	1.915,00	54
D249 17	2.097,00	54

Cod.	€	pag.
D242 10	305,00	52
D242 11	375,00	52
D242 12	305,00	52
D242 13	445,00	52

**Art. D248**



D820 10	260,00	55
D820 11	260,00	55

Cod.	€	pag.
D248 10	597,00	53
D248 11	737,00	53
D248 12	878,00	53
D248 13	1.018,00	53
D248 14	1.159,00	53
D248 15	1.299,00	53
D248 16	1.440,00	53
D248 17	1.580,00	53
D248 18	1.720,00	53

**Art. D249**



D256 10	346,00	56
D256 11	428,00	56
D256 12	428,00	56
D256 13	447,00	56
D256 14	580,00	56

Cod.	€	pag.
D249 10	819,00	54
D249 11	1.000,00	54
D249 12	1.184,00	54

**Art. D820**



**Art. D836**



D836 10	12,00	55
---------	-------	----

**Art. D256**



Cod.	€	pag.
D256 10	346,00	56
D256 11	428,00	56
D256 12	428,00	56
D256 13	447,00	56
D256 14	580,00	56

**Art. D252**



Cod.	€	pag.
D252 10	585,00	57
D252 11	609,00	57
D252 12	596,00	57
D252 13	620,00	57
D252 14	632,00	57
D252 15	644,00	57
D252 16	630,00	57
D252 17	655,00	57
D252 18	644,00	57
D252 19	667,00	57

**Art. D309**



D309 10	246,00	58
---------	--------	----

**Art. D351**



D351 10	112,00	58
---------	--------	----

**Art. D833**



pag. 59

Cod.	€	pag.
D833 10	92,00	59
D833 11	92,00	59
D833 12	92,00	59
D833 13	92,00	59

**Art. D109**



pag. 59

Cod.	€	pag.
D109 10	161,00	59
D109 11	245,00	59
D109 12	161,00	59
D109 13	245,00	59

**Art. D701**



pag. 60

Cod. DX / RH	€	pag.
D701 10	129,00	60
D701 11	129,00	60
D701 12	129,00	60
D701 13	129,00	60
D701 14	141,00	60
D701 15	141,00	60
D701 16	141,00	60
D701 17	141,00	60
Cod. SX / LH	€	pag.
D701 18	129,00	60
D701 19	129,00	60
D701 20	129,00	60
D701 21	129,00	60

D701 22	141,00	60
D701 23	141,00	60
D701 24	141,00	60
D701 25	141,00	60

**Art. D702**



pag. 60

Cod. DX / RH	€	pag.
D702 10	129,00	60
D702 11	129,00	60
D702 12	129,00	60
D702 13	129,00	60
D702 14	129,00	60
D702 15	129,00	60
D702 16	129,00	60
D702 17	129,00	60
D702 18	141,00	60
D702 19	141,00	60
D702 20	141,00	60
D702 21	152,00	60
Cod. SX / LH	€	pag.
D702 22	129,00	60
D702 23	129,00	60
D702 24	129,00	60
D702 25	129,00	60
D702 26	129,00	60
D702 27	129,00	60
D702 28	129,00	60
D702 29	129,00	60
D702 30	141,00	60
D702 31	141,00	60
D702 32	141,00	60
D702 33	152,00	60

**Art. D703**



pag. 61

Cod. DX / RH	€	pag.
D703 10	129,00	61
D703 11	129,00	61
D703 12	129,00	61
D703 13	129,00	61

D703 14	129,00	61
D703 15	129,00	61
D703 16	129,00	61
D703 17	129,00	61
D703 18	141,00	61
D703 19	141,00	61
D703 20	141,00	61
D703 21	152,00	61

Cod. SX / LH	€	pag.
D703 22	129,00	61
D703 23	129,00	61
D703 24	129,00	61
D703 25	129,00	61
D703 26	129,00	61
D703 27	129,00	61
D703 28	129,00	61
D703 29	129,00	61
D703 30	141,00	61
D703 31	141,00	61
D703 32	141,00	61
D703 33	152,00	61

**Art. D705**



pag. 61

Cod. DX / RH	€	pag.
D705 10	199,00	61
D705 11	199,00	61
D705 12	199,00	61
D705 13	199,00	61
D705 14	199,00	61
D705 15	199,00	61
D705 16	199,00	61
D705 17	199,00	61
D705 18	211,00	61
D705 19	211,00	61
D705 20	211,00	61
D705 21	211,00	61
D705 22	211,00	61
D705 23	211,00	61

Cod. SX / LH	€	pag.
D705 24	199,00	61
D705 25	199,00	61
D705 26	199,00	61
D705 27	199,00	61
D705 28	199,00	61
D705 29	199,00	61
D705 30	199,00	61
D705 31	199,00	61
D705 32	211,00	61
D705 33	211,00	61
D705 34	211,00	61
D705 35	211,00	61
D705 36	211,00	61
D705 37	211,00	61



## Art. D704

pag.  
62

Cod. DX / RH	€	pag.
D704 10	164,00	62
D704 11	164,00	62
D704 12	164,00	62
D704 13	164,00	62
D704 14	164,00	62
D704 15	164,00	62
D704 16	164,00	62
D704 17	164,00	62
D704 18	164,00	62
D704 19	164,00	62
D704 20	164,00	62
D704 21	164,00	62
D704 22	164,00	62
D704 23	164,00	62
D704 24	188,00	62
D704 25	188,00	62
D704 26	188,00	62
D704 27	188,00	62
D704 28	188,00	62
D704 29	188,00	62
D704 30	188,00	62
D704 31	188,00	62
D704 32	188,00	62
D704 33	188,00	62
Cod. SX / LH	€	pag.
D704 34	164,00	62
D704 35	164,00	62
D704 36	164,00	62
D704 37	164,00	62
D704 38	164,00	62
D704 39	164,00	62
D704 40	164,00	62
D704 41	164,00	62
D704 42	164,00	62
D704 43	164,00	62
D704 44	164,00	62
D704 45	164,00	62
D704 46	164,00	62
D704 47	164,00	62
D704 48	188,00	62
D704 49	188,00	62
D704 50	188,00	62
D704 51	188,00	62
D704 52	188,00	62
D704 53	188,00	62
D704 54	188,00	62
D704 55	188,00	62
D704 56	188,00	62
D704 57	188,00	62



## **FRESE IN DIAMANTE PROFILATE**

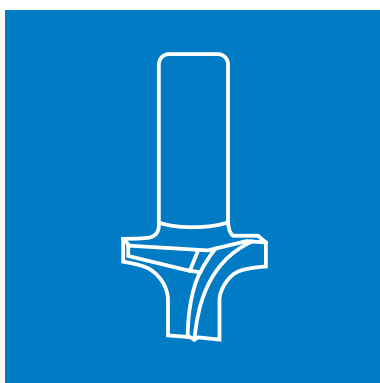

**DIAMOND TOOLS PROFILED**

**PROFILDIAMANTFRÄSER**

**FRESAS EN DIAMANTE PERFILADAS**

**FRAISE EN DIAMANT PROFILEES**

**ПРОФИЛИРОВАННЫЕ АЛМАЗНЫЕ ФРЕЗЫ**

Art. D261



pag. 65

Cod.	€	pag.
D261 10	260,00	65
D261 11	273,00	65
D261 12	273,00	65
D261 13	286,00	65
D261 14	312,00	65
D261 15	338,00	65
D261 16	286,00	65
D261 17	299,00	65
D261 18	299,00	65
D261 19	312,00	65
D261 20	338,00	65
D261 21	364,00	65
D261 22	299,00	65
D261 23	312,00	65
D261 24	312,00	65
D261 25	325,00	65
D261 26	351,00	65
D261 27	364,00	65

Art. D275



pag. 66

Cod.	€	pag.
D275 10	416,00	66
D275 11	494,00	66

Art. D276



pag. 66

Cod.	€	pag.
D276 10	208,00	66
D276 11	273,00	66

Art. D308



pag. 67

Cod.	€	pag.
D308 10	264,00	67
D308 11	264,00	67
D308 12	264,00	67
D308 13	264,00	67

Art. D7A



pag. 68

Cod.	€	pag.
D7A 10	445,00	68
D7A 11	340,00	68
D7A 12	312,00	68
D7A 13	403,00	68
D7A 14	312,00	68
D7A 15	445,00	68
D7A 16	340,00	68
D7A 17	312,00	68
D7A 18	403,00	68
D7A 19	312,00	68

Art. D7B



pag. 70

Cod.	€	pag.
D7B 10	445,00	70
D7B 11	364,00	70
D7B 12	300,00	70
D7B 13	364,00	70
D7B 14	312,00	70
D7B 15	445,00	70
D7B 16	364,00	70
D7B 17	300,00	70
D7B 18	364,00	70
D7B 19	312,00	70

Art. D7C



pag. 72

Cod.	€	pag.
D7C 10	445,00	72
D7C 11	312,00	72
D7C 12	300,00	72
D7C 13	338,00	72
D7C 14	405,00	72
D7C 15	445,00	72
D7C 16	312,00	72
D7C 17	300,00	72
D7C 18	338,00	72
D7C 19	405,00	72



**Art. D7D**



pag.  
74

**Art. D11B**



pag.  
78

**Art. D11D**



pag.  
82

Cod.	€	pag.
D7D 10	445,00	74
D7D 11	312,00	74
D7D 12	400,00	74
D7D 13	364,00	74
D7D 14	445,00	74
D7D 15	312,00	74
D7D 16	400,00	74
D7D 17	364,00	74

Cod.	€	pag.
D11B 10	445,00	78
D11B 11	380,00	78
D11B 12	325,00	78
D11B 13	400,00	78
D11B 14	312,00	78
D11B 15	445,00	78
D11B 16	380,00	78
D11B 17	325,00	78
D11B 18	400,00	78
D11B 19	312,00	78

D11D 10	445,00	82
D11D 11	325,00	82
D11D 12	395,00	82
D11D 13	365,00	82
D11D 14	445,00	82
D11D 15	325,00	82
D11D 16	395,00	82
D11D 17	365,00	82

**Art. D11A**



pag.  
76

**Art. D11C**



pag.  
80

Cod.	€	pag.
D11A 10	445,00	76
D11A 11	380,00	76
D11A 12	338,00	76
D11A 13	415,00	76
D11A 14	312,00	76
D11A 15	445,00	76
D11A 16	380,00	76
D11A 17	338,00	76
D11A 18	415,00	76
D11A 19	312,00	76

D11C 10	445,00	80
D11C 11	330,00	80
D11C 12	351,00	80
D11C 13	365,00	80
D11C 14	416,00	80
D11C 15	445,00	80
D11C 16	330,00	80
D11C 17	351,00	80
D11C 18	365,00	80
D11C 19	416,00	80

## FRESE IN DIAMANTE ANTISCHEGGIA PER RETTIFICA



**DIAMOND TOOLS ANTI-SPLIT FOR GRINDING**

**SPLITTERSCHUTZ DIAMANTFRÄSER ZUM SCHLEIFEN**

**FRESAS EN DIAMANTE INASTILLABLE DE AJUSTE**

**FRAISES EN DIAMANT ANTI ECHARDE POUR AJUSTEMENT**

**АЛМАЗНЫЕ ФРЕЗЫ АНТИ-СКОЛ ДЛЯ ШЛИФОВАНИЯ**



**Art. D250**



pag.  
87

**Art. D251**



pag.  
89

**Art. D255**



pag.  
92

Cod.	€	pag.
D250 10	500,00	87
D250 11	750,00	87
D250 12	1.000,00	87
D250 13	1.250,00	87
D250 14	500,00	87
D250 15	750,00	87
D250 16	1.000,00	87
D250 17	1.250,00	87
D250 18	500,00	87
D250 19	750,00	87
D250 20	1.000,00	87
D250 21	1.250,00	87
D250 22	1.870,00	87

Cod.	€	pag.
D251 10	1.380,00	89
D251 11	1.925,00	89

Cod.	€	pag.
D255 10	710,00	92
D255 11	710,00	92
D255 12	710,00	92
D255 13	811,00	92
D255 14	811,00	92
D255 15	811,00	92
D255 16	913,00	92
D255 17	913,00	92
D255 18	913,00	92
D255 19	710,00	92
D255 20	710,00	92
D255 21	710,00	92
D255 22	811,00	92
D255 23	811,00	92
D255 24	811,00	92
D255 25	913,00	92
D255 26	913,00	92
D255 27	913,00	92

**Art. D260**



pag.  
88

**Art. D253**



pag.  
90

**Art. D265**



pag.  
93

Cod.	€	pag.
D253 10	1.185,00	90
D253 11	1.850,00	90

**Art. D310**



pag.  
91

Cod.	€	pag.
D265 10	874,00	93
D265 11	874,00	93
D265 12	874,00	93
D265 13	1.055,00	93
D265 14	1.055,00	93
D265 15	1.055,00	93
D265 16	1.375,00	93
D265 17	1.375,00	93
D265 18	1.375,00	93
D265 19	874,00	93
D265 20	874,00	93
D265 21	874,00	93
D265 22	1.055,00	93
D265 23	1.055,00	93
D265 24	1.055,00	93
D265 25	1.375,00	93
D265 26	1.375,00	93
D265 27	1.375,00	93



Cod.	€	pag.
D260 10	437,00	88
D260 11	655,00	88
D260 12	874,00	88
D260 13	949,00	88
D260 14	437,00	88
D260 15	655,00	88
D260 16	874,00	88
D260 17	949,00	88
D260 18	437,00	88
D260 19	655,00	88
D260 20	874,00	88
D260 21	949,00	88
D260 22	1.690,00	88

Cod.	€	pag.
D310 10	650,00	91
D310 11	1.150,00	91

Cod. Spare Partes	€	pag.
D310 20	49,00	91
VT 5 x 7 torx	10,00	91
CH T20 torx	6,00	91

## FRESE IN DIAMANTE PER BORDATRICE



EDGEBANDING DIAMOND TOOLS

DIAMANTFRÄSER FÜR KANTENBANDER MASCHINE

FRESAS EN DIAMANTE PARA BANDA DE BORDE

FRAISES EN DIAMANT POUR PLAQUEUSE

АЛМАЗНЫЕ ФРЕЗЫ ДЛЯ КРОМКООБЛИЦОВОЧНОГО СТАНКА



**Art. D429**



pag.  
97

**Art. D502**



pag.  
98

Cod.	€	pag.
D429 10	<b>218,00</b>	97
D429 11	<b>246,00</b>	97
D429 12	<b>262,00</b>	97
D429 13	<b>305,00</b>	97

**Art. D437**



pag.  
97

Cod. DX / RH	€	pag.
D437 10	<b>262,00</b>	97
D437 11	<b>327,00</b>	97
D437 12	<b>327,00</b>	97
D437 13	<b>425,00</b>	97

Cod. SX / LH	€	pag.
D437 110	<b>262,00</b>	97
D437 111	<b>327,00</b>	97
D437 112	<b>327,00</b>	97
D437 113	<b>425,00</b>	97

**Art. D501**



pag.  
98

Cod. DX / RH	€	pag.
D501 10	<b>328,00</b>	98
D501 11	<b>375,00</b>	98
D501 12	<b>328,00</b>	98
D501 13	<b>375,00</b>	98

Cod. SX / LH	€	pag.
D501 110	<b>328,00</b>	98
D501 111	<b>375,00</b>	98
D501 112	<b>328,00</b>	98
D501 113	<b>375,00</b>	98

Cod. DX / RH	€	pag.
D502 10	<b>328,00</b>	98
D502 11	<b>375,00</b>	98
D502 12	<b>328,00</b>	98
D502 13	<b>375,00</b>	98
D502 14	<b>375,00</b>	98
D502 15	<b>384,00</b>	98
D502 16	<b>393,00</b>	98
D502 17	<b>403,00</b>	98

Cod. SX / LH	€	pag.
D502 110	<b>328,00</b>	98
D502 111	<b>375,00</b>	98
D502 112	<b>328,00</b>	98
D502 113	<b>375,00</b>	98
D502 114	<b>375,00</b>	98
D502 115	<b>384,00</b>	98
D502 116	<b>393,00</b>	98
D502 117	<b>403,00</b>	98

**Art. D504**



pag.  
99

Cod. DX / RH	€	pag.
D504 10	<b>328,00</b>	99
D504 11	<b>422,00</b>	99
D504 12	<b>328,00</b>	99
D504 13	<b>422,00</b>	99
D504 14	<b>328,00</b>	99
D504 15	<b>422,00</b>	99
D504 16	<b>328,00</b>	99
D504 17	<b>422,00</b>	99
D504 18	<b>328,00</b>	99

D504 19	<b>422,00</b>	99
D504 20	<b>328,00</b>	99
D504 21	<b>422,00</b>	99
D504 22	<b>328,00</b>	99
D504 23	<b>422,00</b>	99
D504 24	<b>328,00</b>	99
D504 25	<b>422,00</b>	99
D504 26	<b>328,00</b>	99
D504 27	<b>422,00</b>	99
D504 28	<b>328,00</b>	99

D504 29	<b>422,00</b>	99
D504 30	<b>328,00</b>	99
D504 31	<b>422,00</b>	99
D504 32	<b>328,00</b>	99
D504 33	<b>422,00</b>	99
D504 34	<b>328,00</b>	99
D504 35	<b>422,00</b>	99
D504 36	<b>328,00</b>	99
D504 37	<b>422,00</b>	99
D504 38	<b>328,00</b>	99
D504 39	<b>422,00</b>	99
D504 40	<b>328,00</b>	99
D504 41	<b>422,00</b>	99
D504 42	<b>328,00</b>	99
D504 43	<b>422,00</b>	99
D504 44	<b>328,00</b>	99
D504 45	<b>422,00</b>	99

Cod. SX / LH	€	pag.
D504 110	<b>328,00</b>	99
D504 111	<b>422,00</b>	99
D504 112	<b>328,00</b>	99
D504 113	<b>422,00</b>	99
D504 114	<b>328,00</b>	99
D504 115	<b>422,00</b>	99
D504 116	<b>328,00</b>	99
D504 117	<b>422,00</b>	99
D504 118	<b>328,00</b>	99
D504 119	<b>422,00</b>	99
D504 120	<b>328,00</b>	99
D504 121	<b>422,00</b>	99
D504 122	<b>328,00</b>	99
D504 123	<b>422,00</b>	99
D504 124	<b>328,00</b>	99
D504 125	<b>422,00</b>	99
D504 126	<b>328,00</b>	99
D504 127	<b>422,00</b>	99
D504 128	<b>328,00</b>	99
D504 129	<b>422,00</b>	99
D504 130	<b>328,00</b>	99
D504 131	<b>422,00</b>	99
D504 132	<b>328,00</b>	99
D504 133	<b>422,00</b>	99
D504 134	<b>328,00</b>	99
D504 135	<b>422,00</b>	99
D504 136	<b>328,00</b>	99
D504 137	<b>422,00</b>	99
D504 138	<b>328,00</b>	99
D504 139	<b>422,00</b>	99
D504 140	<b>328,00</b>	99
D504 141	<b>422,00</b>	99
D504 142	<b>328,00</b>	99
D504 143	<b>422,00</b>	99
D504 144	<b>328,00</b>	99
D504 145	<b>422,00</b>	99



## Art. D503

pag.  
100

Cod. DX / RH	€	pag.
D503 10	422,00	100
D503 11	422,00	100
D503 12	422,00	100
D503 13	328,00	100
D503 14	422,00	100
D503 15	328,00	100
D503 16	422,00	100
Cod. SX / LH	€	pag.
D503 110	422,00	100
D503 111	422,00	100
D503 112	422,00	100
D503 113	328,00	100
D503 114	422,00	100
D503 115	328,00	100
D503 116	422,00	100

## Art. D505

pag.  
100

Cod. DX / RH	€	pag.
D505 10	492,00	100
D505 11	620,00	100
D505 12	492,00	100
D505 13	620,00	100
Cod. SX / LH	€	pag.
D505 110	492,00	100
D505 111	620,00	100
D505 112	492,00	100
D505 113	620,00	100

## Art. D307

pag.  
101

Cod. DX / RH	€	pag.
D307 10	560,00	101
D307 11	983,00	101
D307 12	655,00	101
D307 13	983,00	101
D307 14	560,00	101
D307 15	843,00	101
D307 16	655,00	101
D307 17	983,00	101
D307 18	468,00	101
D307 19	655,00	101
D307 20	702,00	101
D307 21	983,00	101
D307 22	702,00	101
D307 23	983,00	101
D307 24	702,00	101
D307 25	983,00	101
D307 26	702,00	101
D307 27	983,00	101
D307 28	702,00	101
D307 29	562,00	101
D307 30	702,00	101
D307 31	983,00	101
D307 32	702,00	101
D307 33	983,00	101
D307 34	702,00	101
D307 35	983,00	101
D307 36	468,00	101
D307 37	702,00	101
D307 38	983,00	101
D307 39	1.264,00	101
D307 40	1.545,00	101
D307 41	562,00	101
D307 42	655,00	101
D307 43	702,00	101
D307 44	983,00	101
D307 45	655,00	101
D307 46	842,00	101
D307 47	655,00	101
D307 48	1.123,00	101
D307 49	983,00	101
D307 50	702,00	101
D307 51	983,00	101
D307 52	1.264,00	101
D307 53	468,00	101
D307 54	655,00	101
D307 55	983,00	101
D307 56	468,00	101
D307 57	655,00	101
D307 58	468,00	101
D307 59	655,00	101
D307 60	468,00	101
D307 61	655,00	101

Cod. SX / LH	€	pag.
D307 110	560,00	101
D307 111	983,00	101
D307 112	655,00	101
D307 113	983,00	101
D307 114	560,00	101
D307 115	843,00	101
D307 116	655,00	101
D307 117	983,00	101
D307 118	468,00	101
D307 119	655,00	101
D307 120	702,00	101
D307 121	983,00	101
D307 122	702,00	101
D307 123	983,00	101
D307 124	702,00	101
D307 125	983,00	101
D307 126	702,00	101
D307 127	983,00	101
D307 128	702,00	101
D307 129	562,00	101
D307 130	702,00	101
D307 131	983,00	101
D307 132	702,00	101
D307 133	983,00	101
D307 134	702,00	101
D307 135	983,00	101
D307 136	468,00	101
D307 137	702,00	101
D307 138	983,00	101
D307 139	1.264,00	101
D307 140	1.545,00	101
D307 141	562,00	101
D307 142	655,00	101
D307 143	702,00	101
D307 144	983,00	101
D307 145	655,00	101
D307 146	842,00	101
D307 147	655,00	101
D307 148	1.123,00	101
D307 149	983,00	101
D307 150	702,00	101
D307 151	983,00	101
D307 152	1.264,00	101
D307 153	468,00	101
D307 154	655,00	101
D307 155	983,00	101
D307 156	468,00	101
D307 157	655,00	101
D307 158	468,00	101
D307 159	655,00	101
D307 160	468,00	101
D307 161	655,00	101
Cod. Spare Partes	€	pag.
D307 80	49,00	101
VT 5 x 7 torx	10,00	101
CH T20 torx	6,00	101

## Art. D401

pag.  
103

Cod. DX / RH	€	pag.
D401 10	318,00	103
D401 11	398,00	103
D401 12	398,00	103
D401 13	518,00	103
D401 14	398,00	103
D401 15	518,00	103
D401 16	398,00	103
D401 17	518,00	103
D401 18	438,00	103
D401 19	578,00	103
D401 20	438,00	103
D401 21	578,00	103
D401 22	438,00	103
D401 23	578,00	103
D401 24	438,00	103
D401 25	578,00	103
D401 26	478,00	103
D401 27	638,00	103
D401 28	478,00	103
D401 29	638,00	103
D401 30	478,00	103
D401 31	638,00	103
D401 32	392,00	103
D401 33	509,00	103
D401 34	392,00	103
D401 35	509,00	103
D401 36	392,00	103
D401 37	509,00	103
D401 38	392,00	103
D401 39	509,00	103
D401 40	392,00	103
D401 41	509,00	103
D401 42	392,00	103
D401 43	509,00	103
D401 44	430,00	103
D401 45	570,00	103
D401 46	468,00	103
D401 47	626,00	103
D401 48	278,00	103
D401 49	340,00	103
D401 50	318,00	103
D401 51	398,00	103
D401 52	358,00	103
D401 53	459,00	103
D401 54	398,00	103
D401 55	518,00	103
D401 56	398,00	103
D401 57	518,00	103
D401 58	398,00	103
D401 59	518,00	103
D401 60	398,00	103
D401 61	518,00	103
D401 62	438,00	103

D401 63	578,00	103	D401 129	1.039,00	103
D401 64	438,00	103	D401 130	819,00	103
D401 65	578,00	103	D401 131	1.039,00	103
D401 66	478,00	103	D401 132	819,00	103
D401 67	638,00	103	D401 133	1.039,00	103
D401 68	478,00	103	D401 134	819,00	103
D401 69	638,00	103	D401 135	1.039,00	103
D401 70	478,00	103	D401 136	819,00	103
D401 71	638,00	103	D401 137	1.039,00	103
D401 72	478,00	103	D401 138	654,00	103
D401 73	638,00	103	D401 139	819,00	103
D401 74	478,00	103	D401 140	819,00	103
D401 75	638,00	103	D401 141	1.039,00	103
D401 76	638,00	103	<b>Cod. SX / LH</b>	<b>€</b>	<b>pag.</b>
D401 77	638,00	103	D401 210	318,00	103
D401 78	318,00	103	D401 211	398,00	103
D401 79	318,00	103	D401 212	398,00	103
D401 80	398,00	103	D401 213	518,00	103
D401 81	518,00	103	D401 214	398,00	103
D401 82	398,00	103	D401 215	518,00	103
D401 83	518,00	103	D401 216	398,00	103
D401 84	398,00	103	D401 217	518,00	103
D401 85	518,00	103	D401 218	438,00	103
D401 86	398,00	103	D401 219	578,00	103
D401 87	518,00	103	D401 220	438,00	103
D401 88	398,00	103	D401 221	578,00	103
D401 89	518,00	103	D401 222	438,00	103
D401 90	398,00	103	D401 223	578,00	103
D401 91	518,00	103	D401 224	438,00	103
D401 92	398,00	103	D401 225	578,00	103
D401 93	518,00	103	D401 226	478,00	103
D401 94	398,00	103	D401 227	638,00	103
D401 95	518,00	103	D401 228	478,00	103
D401 96	398,00	103	D401 229	638,00	103
D401 97	518,00	103	D401 230	478,00	103
D401 98	438,00	103	D401 231	638,00	103
D401 99	578,00	103	D401 232	392,00	103
D401 100	438,00	103	D401 233	509,00	103
D401 101	578,00	103	D401 234	392,00	103
D401 102	438,00	103	D401 235	509,00	103
D401 103	578,00	103	D401 236	392,00	103
D401 104	478,00	103	D401 237	509,00	103
D401 105	638,00	103	D401 238	392,00	103
D401 106	478,00	103	D401 239	509,00	103
D401 107	638,00	103	D401 240	392,00	103
D401 108	478,00	103	D401 241	509,00	103
D401 109	638,00	103	D401 242	392,00	103
D401 110	478,00	103	D401 243	509,00	103
D401 111	638,00	103	D401 244	430,00	103
D401 112	478,00	103	D401 245	570,00	103
D401 113	638,00	103	D401 246	468,00	103
D401 114	478,00	103	D401 247	626,00	103
D401 115	638,00	103	D401 248	278,00	103
D401 116	489,00	103	D401 249	340,00	103
D401 117	600,00	103	D401 250	318,00	103
D401 118	654,00	103	D401 251	398,00	103
D401 119	819,00	103	D401 252	358,00	103
D401 120	654,00	103	D401 253	459,00	103
D401 121	819,00	103	D401 254	398,00	103
D401 122	654,00	103	D401 255	518,00	103
D401 123	819,00	103	D401 256	398,00	103
D401 124	654,00	103	D401 257	518,00	103
D401 125	819,00	103	D401 258	398,00	103
D401 126	654,00	103	D401 259	518,00	103
D401 127	819,00	103	D401 260	398,00	103
D401 128	819,00	103	D401 261	518,00	103

D401 262	438,00	103	D401 328	819,00	103	D403 48	309,00	107
D401 263	578,00	103	D401 329	1.039,00	103	D403 49	383,00	107
D401 264	438,00	103	D401 330	819,00	103	D403 50	359,00	107
D401 265	578,00	103	D401 331	1.039,00	103	D403 51	459,00	107
D401 266	478,00	103	D401 332	819,00	103	D403 52	409,00	107
D401 267	638,00	103	D401 333	1.039,00	103	D403 53	534,00	107
D401 268	478,00	103	D401 334	819,00	103	D403 54	459,00	107
D401 269	638,00	103	D401 335	1.039,00	103	D403 55	609,00	107
D401 270	478,00	103	D401 336	819,00	103	D403 56	459,00	107
D401 271	638,00	103	D401 337	1.039,00	103	D403 57	609,00	107
D401 272	478,00	103	D401 338	654,00	103	D403 58	459,00	107
D401 273	638,00	103	D401 339	819,00	103	D403 59	609,00	107
D401 274	478,00	103	D401 340	819,00	103	D403 60	459,00	107
D401 275	638,00	103	D401 341	1.039,00	103	D403 61	609,00	107
D401 276	638,00	103				D403 62	509,00	107
D401 277	638,00	103				D403 63	684,00	107
D401 278	318,00	103				D403 64	509,00	107
D401 279	318,00	103				D403 65	684,00	107
D401 280	398,00	103				D403 66	559,00	107
D401 281	518,00	103				D403 67	759,00	107
D401 282	398,00	103				D403 68	559,00	107
D401 283	518,00	103				D403 69	759,00	107
D401 284	398,00	103				D403 70	559,00	107
D401 285	518,00	103				D403 71	759,00	107
D401 286	398,00	103				D403 72	559,00	107
D401 287	518,00	103				D403 73	759,00	107
D401 288	398,00	103				D403 74	559,00	107
D401 289	518,00	103				D403 75	759,00	107
D401 290	398,00	103				D403 76	759,00	107
D401 291	518,00	103				D403 77	759,00	107
D401 292	398,00	103				D403 78	359,00	107
D401 293	518,00	103				D403 79	359,00	107
D401 294	398,00	103				D403 80	459,00	107
D401 295	518,00	103				D403 81	609,00	107
D401 296	398,00	103				D403 82	459,00	107
D401 297	518,00	103				D403 83	609,00	107
D401 298	438,00	103				D403 84	459,00	107
D401 299	578,00	103				D403 85	609,00	107
D401 300	438,00	103				D403 86	459,00	107
D401 301	578,00	103				D403 87	609,00	107
D401 302	438,00	103				D403 88	459,00	107
D401 303	578,00	103				D403 89	609,00	107
D401 304	478,00	103				D403 90	459,00	107
D401 305	638,00	103				D403 91	609,00	107
D401 306	478,00	103				D403 92	459,00	107
D401 307	638,00	103				D403 93	609,00	107
D401 308	478,00	103				D403 94	459,00	107
D401 309	638,00	103				D403 95	609,00	107
D401 310	478,00	103				D403 96	459,00	107
D401 311	638,00	103				D403 97	609,00	107
D401 312	478,00	103				D403 98	509,00	107
D401 313	638,00	103				D403 99	684,00	107
D401 314	478,00	103				D403 100	509,00	107
D401 315	638,00	103				D403 101	684,00	107
D401 316	489,00	103				D403 102	509,00	107
D401 317	600,00	103				D403 103	684,00	107
D401 318	654,00	103				D403 104	558,00	107
D401 319	819,00	103				D403 105	759,00	107
D401 320	654,00	103				D403 106	558,00	107
D401 321	819,00	103				D403 107	759,00	107
D401 322	654,00	103				D403 108	558,00	107
D401 323	819,00	103				D403 109	759,00	107
D401 324	654,00	103				D403 110	558,00	107
D401 325	819,00	103				D403 111	759,00	107
D401 326	654,00	103				D403 112	558,00	107
D401 327	819,00	103				D403 113	759,00	107

## Art. D403

pag.  
107

Cod. DX / RH	€	pag.
D403 10	355,00	107
D403 11	455,00	107
D403 12	455,00	107
D403 13	600,00	107
D403 14	453,00	107
D403 15	600,00	107
D403 16	453,00	107
D403 17	600,00	107
D403 18	500,00	107
D403 19	673,00	107
D403 20	500,00	107
D403 21	674,00	107
D403 22	500,00	107
D403 23	673,00	107
D403 24	500,00	107
D403 25	673,00	107
D403 26	550,00	107
D403 27	747,00	107
D403 28	550,00	107
D403 29	747,00	107
D403 30	550,00	107
D403 31	747,00	107
D403 32	459,00	107
D403 33	609,00	107
D403 34	459,00	107
D403 35	609,00	107
D403 36	459,00	107
D403 37	609,00	107
D403 38	459,00	107
D403 39	609,00	107
D403 40	459,00	107
D403 41	609,00	107
D403 42	459,00	107
D403 43	609,00	107
D403 44	509,00	107
D403 45	684,00	107
D403 46	559,00	107
D403 47	759,00	107

D403 114	558,00	107	D403 247	759,00	107	D403 313	759,00	107
D403 115	759,00	107	D403 248	309,00	107	D403 314	558,00	107
D403 116	489,00	107	D403 249	383,00	107	D403 315	759,00	107
D403 117	599,00	107	D403 250	359,00	107	D403 316	489,00	107
D403 118	654,00	107	D403 251	459,00	107	D403 317	599,00	107
D403 119	819,00	107	D403 252	409,00	107	D403 318	654,00	107
D403 120	654,00	107	D403 253	534,00	107	D403 319	819,00	107
D403 121	819,00	107	D403 254	459,00	107	D403 320	654,00	107
D403 122	654,00	107	D403 255	609,00	107	D403 321	819,00	107
D403 123	819,00	107	D403 256	459,00	107	D403 322	654,00	107
D403 124	654,00	107	D403 257	609,00	107	D403 323	819,00	107
D403 125	819,00	107	D403 258	459,00	107	D403 324	654,00	107
D403 126	654,00	107	D403 259	609,00	107	D403 325	819,00	107
D403 127	819,00	107	D403 260	459,00	107	D403 326	654,00	107
D403 128	819,00	107	D403 261	609,00	107	D403 327	819,00	107
D403 129	1.040,00	107	D403 262	509,00	107	D403 328	819,00	107
D403 130	819,00	107	D403 263	684,00	107	D403 329	1.040,00	107
D403 131	1.040,00	107	D403 264	509,00	107	D403 330	819,00	107
D403 132	819,00	107	D403 265	684,00	107	D403 331	1.040,00	107
D403 133	1.040,00	107	D403 266	559,00	107	D403 332	819,00	107
D403 134	820,00	107	D403 267	759,00	107	D403 333	1.040,00	107
D403 135	1.040,00	107	D403 268	559,00	107	D403 334	820,00	107
D403 136	820,00	107	D403 269	759,00	107	D403 335	1.040,00	107
D403 137	1.040,00	107	D403 270	559,00	107	D403 336	820,00	107
D403 138	654,00	107	D403 271	759,00	107	D403 337	1.040,00	107
D403 139	819,00	107	D403 272	559,00	107	D403 338	654,00	107
D403 140	819,00	107	D403 273	759,00	107	D403 339	819,00	107
D403 141	1.040,00	107	D403 274	559,00	107	D403 340	819,00	107
<b>Cod. SX / LH</b>	<b>€</b>	<b>pag.</b>	D403 275	759,00	107	D403 341	1.040,00	107
D403 210	355,00	107	D403 276	759,00	107	<p><b>Art. D402</b></p>  <p><b>pag. 111</b></p>		
D403 211	455,00	107	D403 277	759,00	107			
D403 212	455,00	107	D403 278	359,00	107			
D403 213	600,00	107	D403 279	359,00	107			
D403 214	453,00	107	D403 280	459,00	107			
D403 215	600,00	107	D403 281	609,00	107			
D403 216	453,00	107	D403 282	459,00	107			
D403 217	600,00	107	D403 283	609,00	107			
D403 218	500,00	107	D403 284	459,00	107			
D403 219	673,00	107	D403 285	609,00	107			
D403 220	500,00	107	D403 286	459,00	107			
D403 221	674,00	107	D403 287	609,00	107			
D403 222	500,00	107	D403 288	459,00	107			
D403 223	673,00	107	D403 289	609,00	107			
D403 224	500,00	107	D403 290	459,00	107			
D403 225	673,00	107	D403 291	609,00	107			
D403 226	550,00	107	D403 292	459,00	107			
D403 227	747,00	107	D403 293	609,00	107			
D403 228	550,00	107	D403 294	459,00	107			
D403 229	747,00	107	D403 295	609,00	107			
D403 230	550,00	107	D403 296	459,00	107			
D403 231	747,00	107	D403 297	609,00	107			
D403 232	459,00	107	D403 298	509,00	107			
D403 233	609,00	107	D403 299	684,00	107			
D403 234	459,00	107	D403 300	509,00	107			
D403 235	609,00	107	D403 301	684,00	107			
D403 236	459,00	107	D403 302	509,00	107			
D403 237	609,00	107	D403 303	684,00	107			
D403 238	459,00	107	D403 304	558,00	107			
D403 239	609,00	107	D403 305	759,00	107			
D403 240	459,00	107	D403 306	558,00	107			
D403 241	609,00	107	D403 307	759,00	107			
D403 242	459,00	107	D403 308	558,00	107			
D403 243	609,00	107	D403 309	759,00	107			
D403 244	509,00	107	D403 310	558,00	107			
D403 245	684,00	107	D403 311	759,00	107			
D403 246	559,00	107	D403 312	558,00	107			
						<b>Cod. DX / RH</b>	<b>€</b>	<b>pag.</b>
						D402 10	318,00	111
						D402 11	398,00	111
						D402 12	398,00	111
						D402 13	518,00	111
						D402 14	398,00	111
						D402 15	518,00	111
						D402 16	398,00	111
						D402 17	518,00	111
						D402 18	438,00	111
						D402 19	578,00	111
						D402 20	438,00	111
						D402 21	578,00	111
						D402 22	438,00	111
						D402 23	578,00	111
						D402 24	438,00	111
						D402 25	578,00	111
						D402 26	478,00	111
						D402 27	638,00	111
						D402 28	478,00	111
						D402 29	638,00	111
						D402 30	478,00	111
						D402 31	638,00	111
						D402 32	392,00	111



D402 33	508,00	111	D402 99	578,00	111	D402 232	392,00	111
D402 34	392,00	111	D402 100	438,00	111	D402 233	508,00	111
D402 35	508,00	111	D402 101	578,00	111	D402 234	392,00	111
D402 36	392,00	111	D402 102	438,00	111	D402 235	508,00	111
D402 37	508,00	111	D402 103	578,00	111	D402 236	392,00	111
D402 38	392,00	111	D402 104	478,00	111	D402 237	508,00	111
D402 39	508,00	111	D402 105	638,00	111	D402 238	392,00	111
D402 40	392,00	111	D402 106	478,00	111	D402 239	508,00	111
D402 41	508,00	111	D402 107	638,00	111	D402 240	392,00	111
D402 42	392,00	111	D402 108	478,00	111	D402 241	508,00	111
D402 43	508,00	111	D402 109	638,00	111	D402 242	392,00	111
D402 44	431,00	111	D402 110	478,00	111	D402 243	508,00	111
D402 45	567,00	111	D402 111	638,00	111	D402 244	431,00	111
D402 46	470,00	111	D402 112	478,00	111	D402 245	567,00	111
D402 47	626,00	111	D402 113	638,00	111	D402 246	470,00	111
D402 48	278,00	111	D402 114	478,00	111	D402 247	626,00	111
D402 49	338,00	111	D402 115	638,00	111	D402 248	278,00	111
D402 50	318,00	111	D402 116	489,00	111	D402 249	338,00	111
D402 51	398,00	111	D402 117	599,00	111	D402 250	318,00	111
D402 52	358,00	111	D402 118	654,00	111	D402 251	398,00	111
D402 53	458,00	111	D402 119	819,00	111	D402 252	358,00	111
D402 54	398,00	111	D402 120	654,00	111	D402 253	458,00	111
D402 55	518,00	111	D402 121	819,00	111	D402 254	398,00	111
D402 56	398,00	111	D402 122	654,00	111	D402 255	518,00	111
D402 57	518,00	111	D402 123	819,00	111	D402 256	398,00	111
D402 58	398,00	111	D402 124	654,00	111	D402 257	518,00	111
D402 59	518,00	111	D402 125	819,00	111	D402 258	398,00	111
D402 60	398,00	111	D402 126	654,00	111	D402 259	518,00	111
D402 61	518,00	111	D402 127	819,00	111	D402 260	398,00	111
D402 62	438,00	111	D402 128	819,00	111	D402 261	518,00	111
D402 63	578,00	111	D402 129	1.040,00	111	D402 262	438,00	111
D402 64	438,00	111	D402 130	819,00	111	D402 263	578,00	111
D402 65	578,00	111	D402 131	1.040,00	111	D402 264	438,00	111
D402 66	478,00	111	D402 132	819,00	111	D402 265	578,00	111
D402 67	638,00	111	D402 133	1.040,00	111	D402 266	478,00	111
D402 68	478,00	111	D402 134	819,00	111	D402 267	638,00	111
D402 69	638,00	111	D402 135	1.040,00	111	D402 268	478,00	111
D402 70	478,00	111	D402 136	819,00	111	D402 269	638,00	111
D402 71	638,00	111	D402 137	1.040,00	111	D402 270	478,00	111
D402 72	478,00	111	D402 138	654,00	111	D402 271	638,00	111
D402 73	638,00	111	D402 139	819,00	111	D402 272	478,00	111
D402 74	478,00	111	D402 140	819,00	111	D402 273	638,00	111
D402 75	638,00	111	D402 141	1.040,00	111	D402 274	478,00	111
D402 76	638,00	111	<b>Cod. SX / LH</b>	<b>€</b>	<b>pag.</b>	D402 275	638,00	111
D402 77	638,00	111	D402 210	318,00	111	D402 276	638,00	111
D402 78	318,00	111	D402 211	398,00	111	D402 277	638,00	111
D402 79	398,00	111	D402 212	398,00	111	D402 278	318,00	111
D402 80	398,00	111	D402 213	518,00	111	D402 279	398,00	111
D402 81	518,00	111	D402 214	398,00	111	D402 280	398,00	111
D402 82	398,00	111	D402 215	518,00	111	D402 281	518,00	111
D402 83	518,00	111	D402 216	398,00	111	D402 282	398,00	111
D402 84	398,00	111	D402 217	518,00	111	D402 283	518,00	111
D402 85	518,00	111	D402 218	438,00	111	D402 284	398,00	111
D402 86	398,00	111	D402 219	578,00	111	D402 285	518,00	111
D402 87	518,00	111	D402 220	438,00	111	D402 286	398,00	111
D402 88	398,00	111	D402 221	578,00	111	D402 287	518,00	111
D402 89	518,00	111	D402 222	438,00	111	D402 288	398,00	111
D402 90	398,00	111	D402 223	578,00	111	D402 289	518,00	111
D402 91	518,00	111	D402 224	438,00	111	D402 290	398,00	111
D402 92	398,00	111	D402 225	578,00	111	D402 291	518,00	111
D402 93	518,00	111	D402 226	478,00	111	D402 292	398,00	111
D402 94	398,00	111	D402 227	638,00	111	D402 293	518,00	111
D402 95	518,00	111	D402 228	478,00	111	D402 294	398,00	111
D402 96	398,00	111	D402 229	638,00	111	D402 295	518,00	111
D402 97	518,00	111	D402 230	478,00	111	D402 296	398,00	111
D402 98	438,00	111	D402 231	638,00	111	D402 297	518,00	111



D402 298	438,00	111	D404 18	502,00	115	D404 84	459,00	115
D402 299	578,00	111	D404 19	673,00	115	D404 85	609,00	115
D402 300	438,00	111	D404 20	502,00	115	D404 86	459,00	115
D402 301	578,00	111	D404 21	674,00	115	D404 87	609,00	115
D402 302	438,00	111	D404 22	502,00	115	D404 88	459,00	115
D402 303	578,00	111	D404 23	674,00	115	D404 89	609,00	115
D402 304	478,00	111	D404 24	502,00	115	D404 90	459,00	115
D402 305	638,00	111	D404 25	674,00	115	D404 91	609,00	115
D402 306	478,00	111	D404 26	551,00	115	D404 92	459,00	115
D402 307	638,00	111	D404 27	748,00	115	D404 93	609,00	115
D402 308	478,00	111	D404 28	551,00	115	D404 94	459,00	115
D402 309	638,00	111	D404 29	748,00	115	D404 95	609,00	115
D402 310	478,00	111	D404 30	551,00	115	D404 96	459,00	115
D402 311	638,00	111	D404 31	748,00	115	D404 97	609,00	115
D402 312	478,00	111	D404 32	459,00	115	D404 98	509,00	115
D402 313	638,00	111	D404 33	610,00	115	D404 99	685,00	115
D402 314	478,00	111	D404 34	459,00	115	D404 100	509,00	115
D402 315	638,00	111	D404 35	610,00	115	D404 101	685,00	115
D402 316	489,00	111	D404 36	459,00	115	D404 102	509,00	115
D402 317	599,00	111	D404 37	610,00	115	D404 103	685,00	115
D402 318	654,00	111	D404 38	459,00	115	D404 104	558,00	115
D402 319	819,00	111	D404 39	610,00	115	D404 105	760,00	115
D402 320	654,00	111	D404 40	459,00	115	D404 106	558,00	115
D402 321	819,00	111	D404 41	610,00	115	D404 107	760,00	115
D402 322	654,00	111	D404 42	459,00	115	D404 108	558,00	115
D402 323	819,00	111	D404 43	610,00	115	D404 109	760,00	115
D402 324	654,00	111	D404 44	509,00	115	D404 110	558,00	115
D402 325	819,00	111	D404 45	685,00	115	D404 111	760,00	115
D402 326	654,00	111	D404 46	560,00	115	D404 112	558,00	115
D402 327	819,00	111	D404 47	760,00	115	D404 113	760,00	115
D402 328	819,00	111	D404 48	309,00	115	D404 114	558,00	115
D402 329	1.040,00	111	D404 49	384,00	115	D404 115	760,00	115
D402 330	819,00	111	D404 50	358,00	115	D404 116	489,00	115
D402 331	1.040,00	111	D404 51	459,00	115	D404 117	600,00	115
D402 332	819,00	111	D404 52	409,00	115	D404 118	654,00	115
D402 333	1.040,00	111	D404 53	534,00	115	D404 119	819,00	115
D402 334	819,00	111	D404 54	534,00	115	D404 120	654,00	115
D402 335	1.040,00	111	D404 55	459,00	115	D404 121	819,00	115
D402 336	819,00	111	D404 56	609,00	115	D404 122	654,00	115
D402 337	1.040,00	111	D404 57	459,00	115	D404 123	819,00	115
D402 338	654,00	111	D404 58	609,00	115	D404 124	654,00	115
D402 339	819,00	111	D404 59	459,00	115	D404 125	819,00	115
D402 340	819,00	111	D404 60	609,00	115	D404 126	654,00	115
D402 341	1.040,00	111	D404 61	459,00	115	D404 127	819,00	115
			D404 62	609,00	115	D404 128	819,00	115
			D404 63	509,00	115	D404 129	1.039,00	115
			D404 64	684,00	115	D404 130	819,00	115
			D404 65	509,00	115	D404 131	1.039,00	115
			D404 66	685,00	115	D404 132	819,00	115
			D404 67	558,00	115	D404 133	1.039,00	115
			D404 68	760,00	115	D404 134	819,00	115
			D404 69	560,00	115	D404 135	1.039,00	115
			D404 70	760,00	115	D404 136	819,00	115
			D404 71	560,00	115	D404 137	1.039,00	115
			D404 72	760,00	115	D404 138	654,00	115
			D404 73	560,00	115	D404 139	819,00	115
			D404 74	760,00	115	D404 140	819,00	115
			D404 75	560,00	115	D404 141	1.039,00	115
			D404 76	760,00	115			
			D404 77	760,00	115	<b>Cod. SX / LH</b>	<b>€</b>	<b>pag.</b>
			D404 78	360,00	115	D404 210	355,00	115
			D404 79	460,00	115	D404 211	453,00	115
			D404 80	459,00	115	D404 212	453,00	115
			D404 81	609,00	115	D404 213	600,00	115
			D404 82	459,00	115	D404 214	453,00	115
			D404 83	609,00	115	D404 215	600,00	115
						D404 216	453,00	115

## Art. D404

pag.  
115

Cod. DX / RH	€	pag.
D404 10	355,00	115
D404 11	453,00	115
D404 12	453,00	115
D404 13	600,00	115
D404 14	453,00	115
D404 15	600,00	115
D404 16	453,00	115
D404 17	600,00	115

D404 217	600,00	115	D404 283	609,00	115
D404 218	502,00	115	D404 284	459,00	115
D404 219	673,00	115	D404 285	609,00	115
D404 220	502,00	115	D404 286	459,00	115
D404 221	674,00	115	D404 287	609,00	115
D404 222	502,00	115	D404 288	459,00	115
D404 223	674,00	115	D404 289	609,00	115
D404 224	502,00	115	D404 290	459,00	115
D404 225	674,00	115	D404 291	609,00	115
D404 226	551,00	115	D404 292	459,00	115
D404 227	748,00	115	D404 293	609,00	115
D404 228	551,00	115	D404 294	459,00	115
D404 229	748,00	115	D404 295	609,00	115
D404 230	551,00	115	D404 296	459,00	115
D404 231	748,00	115	D404 297	609,00	115
D404 232	459,00	115	D404 298	509,00	115
D404 233	610,00	115	D404 299	685,00	115
D404 234	459,00	115	D404 300	509,00	115
D404 235	610,00	115	D404 301	685,00	115
D404 236	459,00	115	D404 302	509,00	115
D404 237	610,00	115	D404 303	685,00	115
D404 238	459,00	115	D404 304	558,00	115
D404 239	610,00	115	D404 305	760,00	115
D404 240	459,00	115	D404 306	558,00	115
D404 241	610,00	115	D404 307	760,00	115
D404 242	459,00	115	D404 308	558,00	115
D404 243	610,00	115	D404 309	760,00	115
D404 244	509,00	115	D404 310	558,00	115
D404 245	685,00	115	D404 311	760,00	115
D404 246	560,00	115	D404 312	558,00	115
D404 247	760,00	115	D404 313	760,00	115
D404 248	309,00	115	D404 314	558,00	115
D404 249	384,00	115	D404 315	760,00	115
D404 250	358,00	115	D404 316	489,00	115
D404 251	459,00	115	D404 317	600,00	115
D404 252	409,00	115	D404 318	654,00	115
D404 253	534,00	115	D404 319	819,00	115
D404 254	534,00	115	D404 320	654,00	115
D404 255	459,00	115	D404 321	819,00	115
D404 256	609,00	115	D404 322	654,00	115
D404 257	459,00	115	D404 323	819,00	115
D404 258	609,00	115	D404 324	654,00	115
D404 259	459,00	115	D404 325	819,00	115
D404 260	609,00	115	D404 326	654,00	115
D404 261	459,00	115	D404 327	819,00	115
D404 262	609,00	115	D404 328	819,00	115
D404 263	509,00	115	D404 329	1.039,00	115
D404 264	684,00	115	D404 330	819,00	115
D404 265	509,00	115	D404 331	1.039,00	115
D404 266	685,00	115	D404 332	819,00	115
D404 267	558,00	115	D404 333	1.039,00	115
D404 268	760,00	115	D404 334	819,00	115
D404 269	560,00	115	D404 335	1.039,00	115
D404 270	760,00	115	D404 336	819,00	115
D404 271	560,00	115	D404 337	1.039,00	115
D404 272	760,00	115	D404 338	654,00	115
D404 273	560,00	115	D404 339	819,00	115
D404 274	760,00	115	D404 340	819,00	115
D404 275	560,00	115	D404 341	1.039,00	115
D404 276	760,00	115			
D404 277	760,00	115			
D404 278	360,00	115			
D404 279	460,00	115			
D404 280	459,00	115			
D404 281	609,00	115			
D404 282	459,00	115			

## Art. D413

pag.  
119

Cod. DX / RH	€	pag.
D413 10	379,00	119
D413 11	489,00	119
D413 12	433,00	119
D413 13	571,00	119
D413 14	544,00	119
D413 15	737,00	119
D413 16	600,00	119
D413 17	819,00	119
D413 18	600,00	119
D413 19	819,00	119
D413 20	600,00	119
D413 21	819,00	119
D413 22	600,00	119
D413 23	819,00	119
D413 24	654,00	119
D413 25	900,00	119
D413 26	654,00	119
D413 27	900,00	119
D413 28	654,00	119
D413 29	900,00	119
D413 30	900,00	119
D413 31	654,00	119
D413 32	654,00	119
D413 33	900,00	119
D413 34	654,00	119
D413 35	900,00	119
D413 36	654,00	119
D413 37	900,00	119
D413 38	819,00	119
D413 39	900,00	119
D413 40	489,00	119
D413 41	654,00	119
D413 42	600,00	119
D413 43	819,00	119
D413 44	600,00	119
D413 45	819,00	119
D413 46	600,00	119
D413 47	819,00	119
D413 48	600,00	119
D413 49	819,00	119
D413 50	600,00	119
D413 51	819,00	119
D413 52	600,00	119
D413 53	819,00	119
D413 54	600,00	119
D413 55	819,00	119
D413 56	600,00	119
D413 57	819,00	119
D413 58	600,00	119
D413 59	819,00	119
D413 60	654,00	119
D413 61	900,00	119

D413 62	654,00	119
D413 63	900,00	119
D413 64	654,00	119
D413 65	900,00	119
D413 66	654,00	119
D413 67	900,00	119
D413 68	654,00	119
D413 69	900,00	119
D413 70	654,00	119
D413 71	900,00	119
D413 72	654,00	119
D413 73	900,00	119
D413 74	654,00	119
D413 75	900,00	119
D413 76	654,00	119
D413 77	900,00	119
D413 78	654,00	119
D413 79	819,00	119
D413 80	819,00	119
D413 81	1.038,00	119
D413 82	819,00	119
D413 83	1.038,00	119
D413 84	819,00	119
D413 85	1.038,00	119
D413 86	819,00	119
D413 87	1.038,00	119
D413 88	819,00	119
D413 89	1.038,00	119
D413 90	902,00	119
D413 91	1.150,00	119
D413 92	900,00	119
D413 93	1.150,00	119
D413 94	900,00	119
D413 95	1.150,00	119
D413 96	900,00	119
D413 97	1.150,00	119
D413 98	900,00	119
D413 99	1.150,00	119
D413 100	819,00	119
D413 101	1.038,00	119
D413 102	819,00	119
D413 103	1.038,00	119
<b>Cod. SX / LH</b>	<b>€</b>	<b>pag.</b>
D413 210	379,00	119
D413 211	489,00	119
D413 212	433,00	119
D413 213	571,00	119
D413 214	544,00	119
D413 215	737,00	119
D413 216	600,00	119
D413 217	819,00	119
D413 218	600,00	119
D413 219	819,00	119
D413 220	600,00	119
D413 221	819,00	119
D413 222	600,00	119
D413 223	819,00	119
D413 224	654,00	119
D413 225	900,00	119
D413 226	654,00	119
D413 227	900,00	119
D413 228	654,00	119
D413 229	900,00	119
D413 230	900,00	119
D413 231	654,00	119
D413 232	654,00	119

D413 233	900,00	119
D413 234	654,00	119
D413 235	900,00	119
D413 236	654,00	119
D413 237	900,00	119
D413 238	819,00	119
D413 239	900,00	119
D413 240	489,00	119
D413 241	654,00	119
D413 242	600,00	119
D413 243	819,00	119
D413 244	600,00	119
D413 245	819,00	119
D413 246	600,00	119
D413 247	819,00	119
D413 248	600,00	119
D413 249	819,00	119
D413 250	600,00	119
D413 251	819,00	119
D413 252	600,00	119
D413 253	819,00	119
D413 254	600,00	119
D413 255	819,00	119
D413 256	600,00	119
D413 257	819,00	119
D413 258	600,00	119
D413 259	819,00	119
D413 260	654,00	119
D413 261	900,00	119
D413 262	654,00	119
D413 263	900,00	119
D413 264	654,00	119
D413 265	900,00	119
D413 266	654,00	119
D413 267	900,00	119
D413 268	654,00	119
D413 269	900,00	119
D413 270	654,00	119
D413 271	900,00	119
D413 272	654,00	119
D413 273	900,00	119
D413 274	654,00	119
D413 275	900,00	119
D413 276	654,00	119
D413 277	900,00	119
D413 78	654,00	119
D413 79	819,00	119
D413 80	819,00	119
D413 81	1.038,00	119
D413 82	819,00	119
D413 83	1.038,00	119
D413 84	819,00	119
D413 85	1.038,00	119
D413 86	819,00	119
D413 87	1.038,00	119
D413 88	819,00	119
D413 89	1.038,00	119
D413 90	902,00	119
D413 91	1.150,00	119
D413 92	900,00	119
D413 93	1.150,00	119
D413 94	900,00	119
D413 95	1.150,00	119
D413 96	900,00	119
D413 97	1.150,00	119
D413 98	900,00	119

D413 99	1.150,00	119
D413 100	819,00	119
D413 101	1.038,00	119
D413 102	819,00	119
D413 103	1.038,00	119

**Art. D419**

pag.  
122



Cod. DX / RH	€	pag.
D419 10	638,00	122
D419 11	842,00	122
D419 12	800,00	122
D419 13	1.085,00	122
D419 14	800,00	122
D419 15	1.085,00	122
D419 16	800,00	122
D419 17	1.085,00	122
D419 18	800,00	122
D419 19	1.085,00	122
D419 20	800,00	122
D419 21	1.085,00	122
D419 22	800,00	122
D419 23	1.085,00	122
D419 24	800,00	122
D419 25	1.085,00	122
D419 26	800,00	122
D419 27	1.085,00	122
D419 28	800,00	122
D419 29	1.085,00	122
D419 30	882,00	122
D419 31	1.209,00	122
D419 32	882,00	122
D419 33	1.209,00	122
D419 34	882,00	122
D419 35	1.209,00	122
D419 36	882,00	122
D419 37	1.209,00	122
D419 38	882,00	122
D419 39	1.209,00	122
D419 40	882,00	122
D419 41	1.209,00	122
D419 42	882,00	122
D419 43	1.209,00	122
D419 44	882,00	122
D419 45	1.209,00	122
D419 46	882,00	122
D419 47	1.400,00	122
D419 48	685,00	122
D419 49	859,00	122
D419 50	894,00	122
D419 51	1.140,00	122
D419 52	894,00	122
D419 53	1.140,00	122
D419 54	894,00	122
D419 55	1.140,00	122
D419 56	894,00	122



D419 57	1.140,00	122	D419 58	894,00	122
D419 58	894,00	122	D419 59	1.140,00	122
D419 59	1.140,00	122	D419 60	1.210,00	122
D419 60	1.210,00	122	D419 61	1.560,00	122
D419 61	1.560,00	122	D419 62	1.210,00	122
D419 62	1.210,00	122	D419 63	1.560,00	122
D419 63	1.560,00	122	D419 64	1.210,00	122
D419 64	1.210,00	122	D419 65	1.560,00	122
D419 65	1.560,00	122	D419 66	1.210,00	122
D419 66	1.210,00	122	D419 67	1.560,00	122
D419 67	1.560,00	122	D419 68	1.210,00	122
D419 68	1.210,00	122	D419 69	1.560,00	122
D419 69	1.560,00	122	D419 70	1.210,00	122
D419 70	1.210,00	122	D419 71	1.560,00	122
D419 71	1.560,00	122	D419 72	1.210,00	122
D419 72	1.210,00	122	D419 73	1.560,00	122
D419 73	1.560,00	122			

Cod. SX / LH	€	pag.
D419 210	638,00	122
D419 211	842,00	122
D419 212	800,00	122
D419 213	1.085,00	122
D419 214	800,00	122
D419 215	1.085,00	122
D419 216	800,00	122
D419 217	1.085,00	122
D419 218	800,00	122
D419 219	1.085,00	122
D419 220	800,00	122
D419 221	1.085,00	122
D419 222	800,00	122
D419 223	1.085,00	122
D419 224	800,00	122
D419 225	1.085,00	122
D419 226	800,00	122
D419 227	1.085,00	122
D419 228	800,00	122
D419 229	1.085,00	122
D419 230	882,00	122
D419 231	1.209,00	122
D419 232	882,00	122
D419 233	1.209,00	122
D419 234	882,00	122
D419 235	1.209,00	122
D419 236	882,00	122
D419 237	1.209,00	122
D419 238	882,00	122
D419 239	1.209,00	122
D419 240	882,00	122
D419 241	1.209,00	122
D419 242	882,00	122
D419 243	1.209,00	122
D419 244	882,00	122
D419 245	1.209,00	122
D419 246	882,00	122
D419 247	1.400,00	122
D419 48	685,00	122
D419 49	859,00	122
D419 50	894,00	122
D419 51	1.140,00	122
D419 52	894,00	122
D419 53	1.140,00	122
D419 54	894,00	122
D419 55	1.140,00	122
D419 56	894,00	122
D419 57	1.140,00	122







